

COMPUTERFACTS™

Technical Service Data

ATARI® MODEL 800XL™ COMPUTER



FEATURES COMPLETE SCHEMATICS • PRELIMINARY SERVICE CHECKS • TROUBLESHOOTING TIPS •
EASY-READ WAVEFORMS • REPLACEMENT PARTS LISTS • SEMICONDUCTOR CROSS-REFERENCE

**ATARI
MODEL 800XL
CC11****ATARI
MODEL 800XL
CC11****SAFETY PRECAUTIONS**

See page 12.

PRELIMINARY SERVICE CHECKS

ENCLOSED

INDEX

	Page		Page
Block Diagram	21	Photos	9,10,19,20
Disassembly Instructions	26	Safety Precautions	12
General Operating Instructions	26	Schematics	
GridTrace Location Guide	11	Main	2,27,28,29
IC Pinouts & Terminal Guides	4,25	Power Supply	3
Line Definitions	18	Schematic Notes	13
Logic Chart	22,23	Test Equipment	5
Miscellaneous Adjustments	24	Troubleshooting	5 thru 8
Parts List	14 thru 17		

SAMS™**Howard W. Sams & Co.**

4300 West 62nd Street, P.O. Box 7092, Indianapolis, Indiana 46206 U.S.A.

The listing of any available replacement part herein does not constitute in any case a recommendation, warranty or guaranty by Howard W. Sams & Co. as to the quality and suitability of such replacement part. The numbers of these parts have been compiled from information furnished to Howard W. Sams & Co. by the manufacturers of the particular type of replacement part listed.

Reproduction or use, without express permission, of editorial or pictorial content, in any manner, is prohibited. No patent liability is assumed with respect to the use of the information contained herein.

© 1985 Howard W. Sams & Co.,

4300 West 62nd Street, P.O. Box 7092, Indianapolis, Indiana 46206 U.S.A.

Printed in U.S. of America.

85CC14952**DATE 7-85**

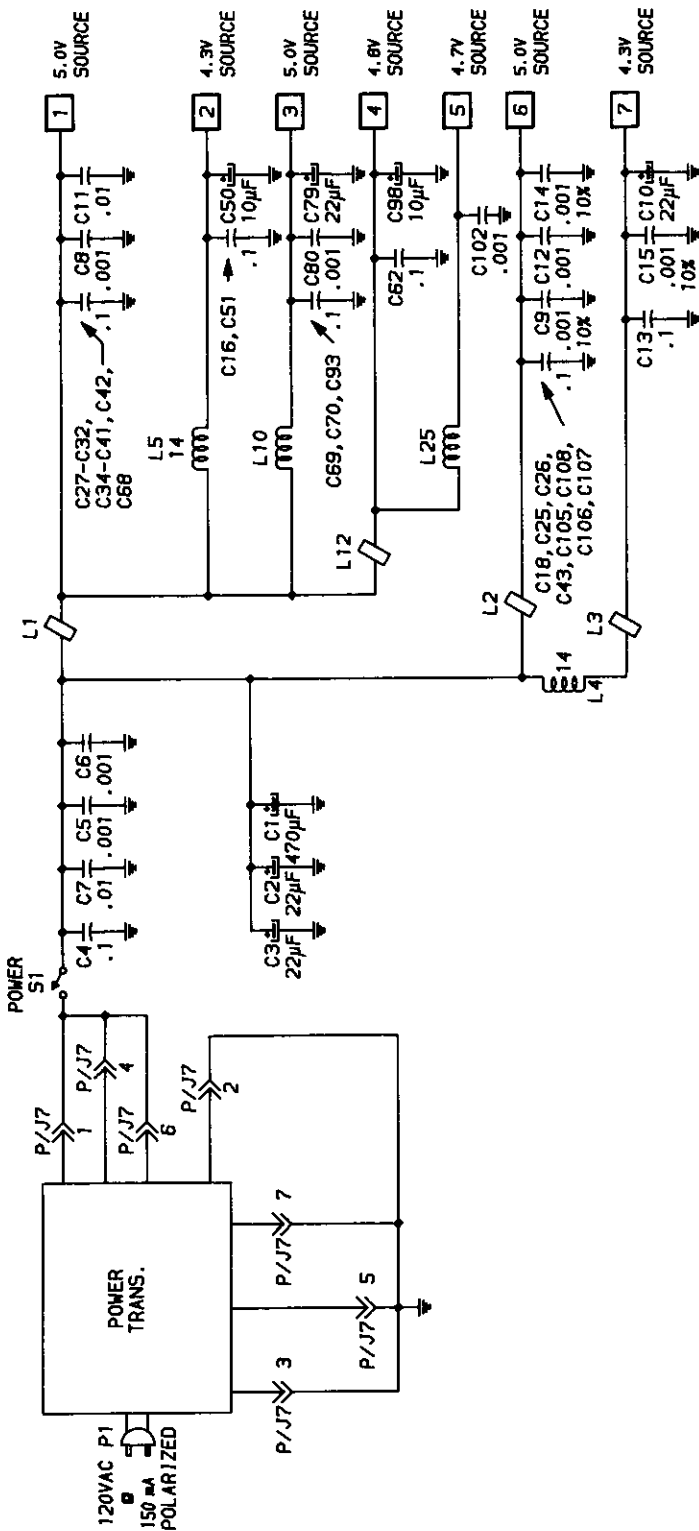

PHOTO CIRCUITRACE = **11**
 SCHEMATIC CIRCUITRACE = **11**

A PHOTOFAC STANDARD NOTATION SCHEMATIC
 WITH **CIRCUITRACE**

© Howard W. Sams & Co 1985

POWER SUPPLY

ATARI
CC-11
 MODEL 800XL

IC PINOUTS & TERMINAL GUIDES

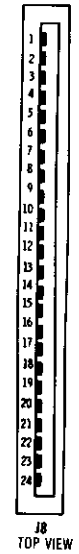
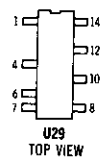
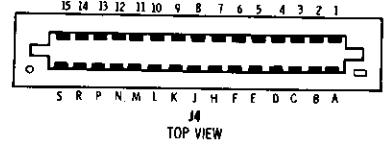
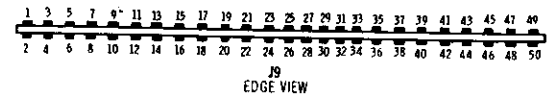
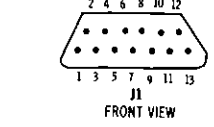
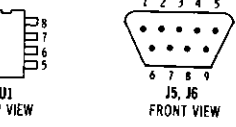
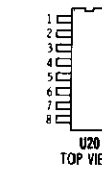
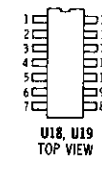
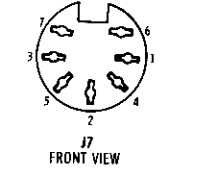
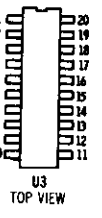
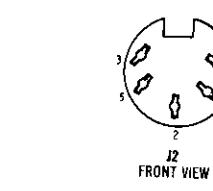
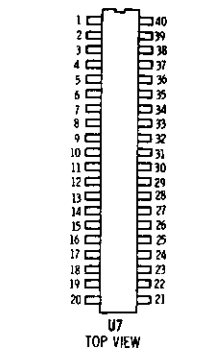
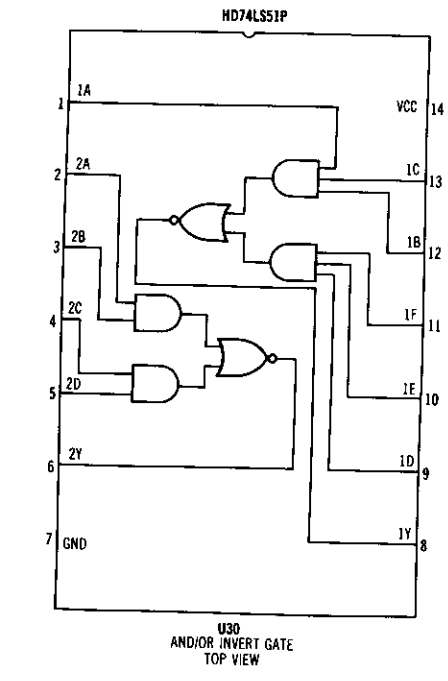
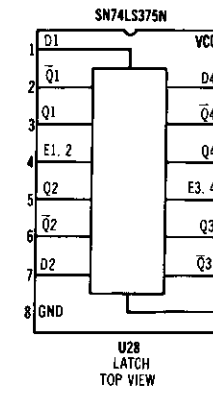
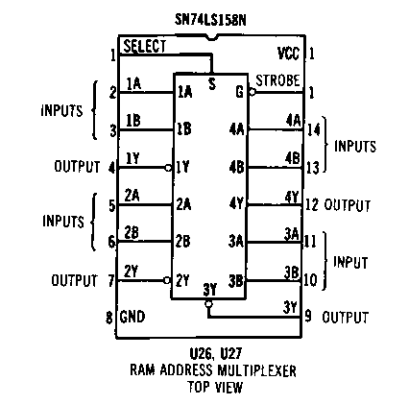
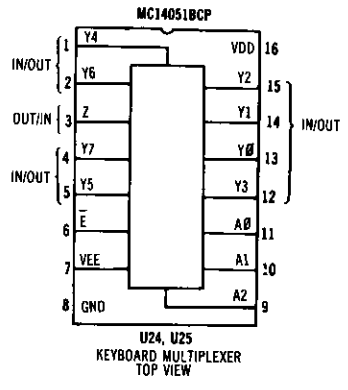
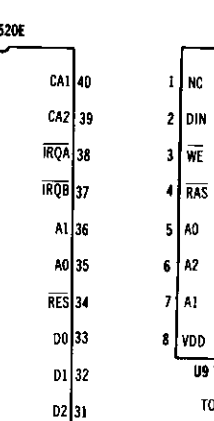
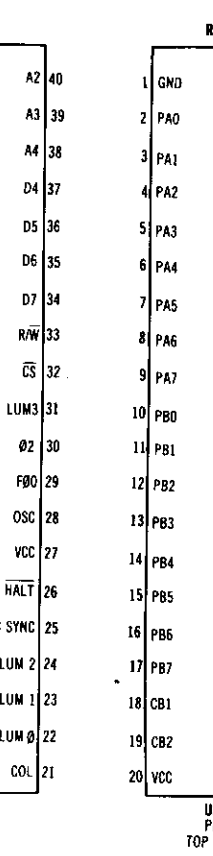
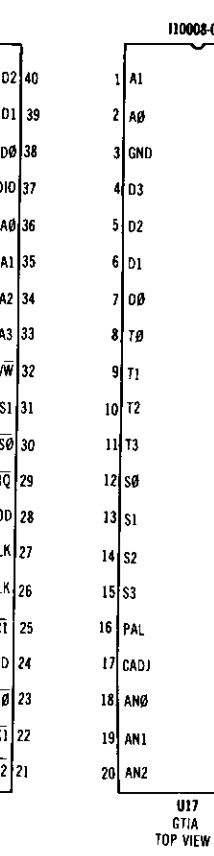
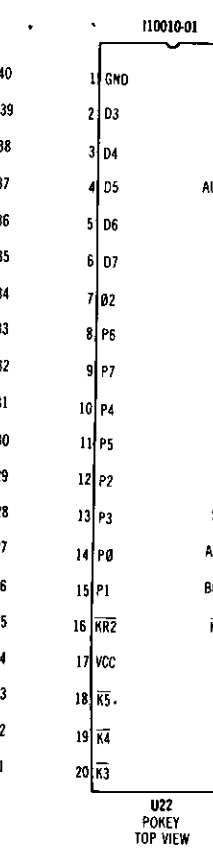
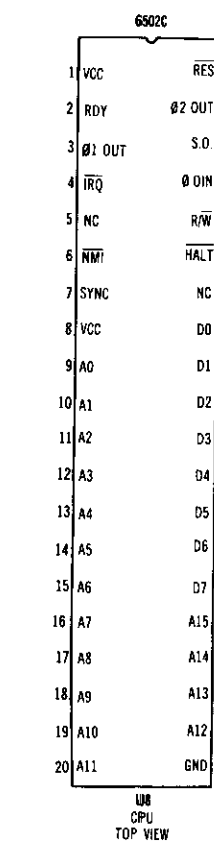
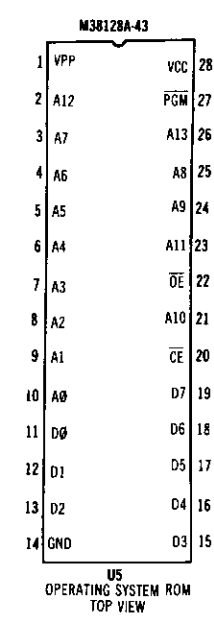
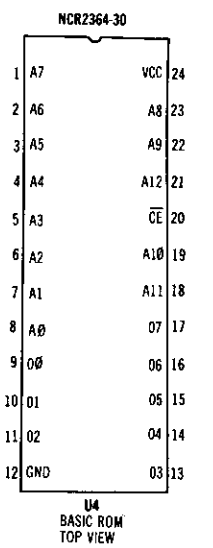
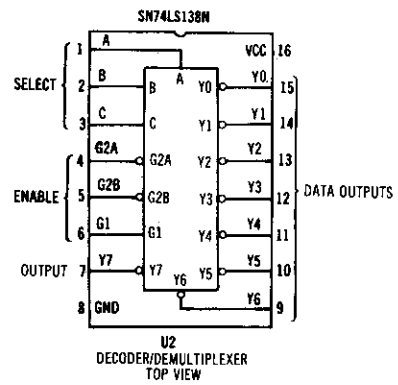

TEST EQUIPMENT

Test Equipment listed by Manufacturer illustrates typical or equivalent equipment used by SAMS' Engineers to obtain measurements and is compatible with most types used by field service technicians.

TEST EQUIPMENT (COMPUTERFACTS)

Equipment Name	B & K Precision Equipment No.	Simpson Equipment No.		
OSCILLOSCOPE	1570A,1590A,1596	454		
LOGIC PROBE	DP51			
LOGIC PULSER	DP101			
DIGITAL VOM	2830	463,467,470,474		
ANALOG VOM	277	260-7		
ISOLATION TRANSFORMER	TR110,1604,1653,1655			
FREQUENCY COUNTER	1803,1805	710		
COLOR BAR GENERATOR	1211A,1248,1251,1260	431		
DISK DRIVE ANALYZER				
FUNCTION GENERATOR	3020	420A,420D		
HI-VOLTAGE PROBE	HV-44	248		

TROUBLESHOOTING

SELF-TEST

The Computer has a built-in self-test. To get the self-test menu, hold the Option key down while turning the Computer On or type the word BYE and press the Return key if the Computer is already On and in Basic. Press the Select key to select the desired test, the Start key to start the test and the Help key to go back to the self-test menu or the Reset key to go back to Basic. The self-test will check the ROM and RAM memory, audio, video and keyboard circuits.

When the Memory test is run, two bars will appear which represent the Operating System ROM IC (U5), then 48 squares will appear, each square representing 1K of RAM IC's (U9 thru U16). While the ROM or RAM is being tested, the color of the bar or square will be white, then change to green if the ROM or RAM is good or red if the ROM or RAM is bad.

When the Audio-Visual test is run, a music staff and treble clef will appear on the screen. A tune of six tones is produced with the corresponding note appearing on the screen when that note is played. Sound channels 1 thru 4 Pokey IC (U22) are tested. An audio defect is indicated by a note appearing on the screen with no sound. A video defect ANTIC IC (U7) and GTIA IC (U17) is indicated by a tone sounding with no note appearing on the screen.

When the Keyboard test is run, the keyboard layout is displayed on the screen. When a key is pressed the corresponding key on the screen should change to inverse video and a tone should sound. The Control and Shift keys will work only when pressed along with another key. All keys except the Reset, Help and Break keys are tested. IC's U17 and U22 are tested.

POWER SUPPLY

Unplug the Power Pack and check for 5.0V from pin 3 to pin

1 of Plug P7. If 5.0V is missing check Plug P7 and the cable for possible open circuits. If the Plug P7 and cable check good replace the Power Pack. Before plugging the new Power Pack into the Computer, check for a possible short from pin 3 to pin 1 of Jack J7 with the Power Switch (S1) in the On position.

If the Power Pack checks good, plug it into the Computer, turn the Computer On and check for 5.0V on the positive end of Electrolytic C2. If 5.0V is missing check the Power Switch (S1).

MICROPROCESSOR (CPU) OPERATION

Check the operation of the Reset Circuit at pin 8 of IC U19. Pin 8 should read a logic Low momentarily, then go logic High and stay High when the Computer is turned On or the Reset key is pressed. If the Reset reading is not correct check Electrolytic C49, Diode CR1, Resistors R39 and R40 and IC U19.

Verify the operation of the Clock Circuits by checking for a 1.78977MHz clock waveform at pin 11 of IC U18. If the waveform is missing or off frequency refer to the "Clock and DIVIDERS" section of this Troubleshooting guide.

Check for pulses on the Address pins (pins 9 thru 20 and 22 thru 25) and Data pins (pins 26 thru 33) of the CPU IC (U8). If pulses are missing or one pin appears to be stuck at a logic Low or High, turn the Computer Off, remove IC U8, turn the Computer back On and recheck the Address and Data pins. The Address pins should read a logic Open and the Data pins a logic High. Also, if pulses are missing with IC U8 in the Computer, check for pulses on the Data pins (pins 26 thru 33) of IC U8 while turning the Computer On or pressing the Reset key. If pulses appear, then suddenly stop, check the Address Decoder IC (U2), Memory Management Unit IC (U3), Operating System and Basic ROM IC's (U4 and U5) and CPU IC (U8).

TROUBLESHOOTING (Continued)

CLOCK AND DIVIDERS

Check for a 3.579545MHz waveform at the collector of Oscillator Transistor (Q8). If the waveform is missing check the voltages and components associated with Oscillator Transistors Q8 and Q9. If the oscillator is off frequency check Crystal Y1. If the waveform is good at the collector of Transistor Q8, check the waveform at pin 29 of the GTIA IC (U17). If the waveform is missing check IC U17. If the waveform is present at pin 29 of IC U17, check for a 1.78977MHz waveform at pin 34 of the ANTIC IC (U7). If the waveform is missing at pin 34 of IC U7, check IC U7. If the waveform is good at pin 34 of IC U7, check for clock pulses at pin 6 of IC U18. If clock pulses are missing at pin 6 of IC U18, check IC U18. If clock pulses are present at pin 6 of IC U18, check for clock pulses at pins 3 and 39 of the CPU IC (U8). If pulses are missing at pin 3 or 39 of IC U8, check IC U8. If pulses are present at pins 3 and 39 of IC U8, check for clock pulses at pin 11 of IC U18. If pulses are missing at pin 11 of IC U18 and pin 13 reads a logic High, check IC U18. If pulses are present at pin 11 of IC U18, check for pulses at pin 2 of IC U19. If pulses are missing at pin 2 of IC U19, check IC U19. If pulses are present at pin 2 of IC U19, check for pulses at pins 4, 6, 8, 10 and 12 of the Delay Line IC (U29). If pulses are missing at any pin, check IC U29.

VIDEO

If there is no video on the Monitor screen and the RF Modulator output is being used, check for a video waveform at pin 1 of the RF Modulator. If the waveform is present, check the RF Modulator, Channel Select Switch (S2) and cable going to the Monitor. If the waveform is missing at pin 1 of the RF Modulator, check for a video waveform at the emitter of the Video Amp Transistor (Q3). If the waveform is present at Transistor Q3 check Coil L6 and Resistor R54. If the waveform is missing at the emitter of Transistor Q3, check the waveform at the base of Transistor Q3. If the waveform is present at the base of Transistor Q3, check Transistor Q3 and the components associated with Transistor Q3. If the waveform is missing at the base of Transistor Q3, check the waveform at pin 5 of the Buffer IC (U20). If the waveform is present at pin 5 of IC U20, check Resistor R49 and IC U20. If the waveform is missing at pin 5 of IC U20, check the GTIA IC (U17) and ANTIC IC (U7).

COLOR

If the color is not correct, check the adjustment of the Color Control (R38), see "Miscellaneous Adjustments". If adjusting R38 has no affect, check for a voltage range of 0V to 8.5V at pin 17 of the GTIA IC (U17) while turning R38 from minimum to maximum. If the voltage is missing or does not vary, check Control R38 and the voltages, waveforms and components associated with Color Amp Transistor (Q1). If the voltage range is correct at pin 17 of IC U17, check for a frequency of 3.579545MHz at pin 28 of IC U17. If the frequency is not correct check Crystal Y1 and the voltages and components associated with Oscillator Transistors (Q8 and Q9). If the frequency is correct, check IC U17.

If there is no color, check the waveform at pin 21 of IC U17. If the waveform is missing check IC U17. If the waveform is present at pin 21 of IC U17, check the waveform at the emitter of the Color Amp Transistor (Q5). If the waveform is missing, check the voltages and components associated with the Color Amp Transistors (Q2, Q4 and Q5). If the waveform is present at the emitter of Transistor Q5, check Capacitors C54 and C55 and Resistors R67 and R68.

VERTICAL AND HORIZONTAL SYNC

If there is no vertical or horizontal sync, check the waveform at pin 25 of the GTIA IC (U17). If the waveform is missing check IC U17. If the waveform is present check Buffer IC (U20), Diode CR4 and Resistor R51.

SOUND

No sound. Type in and run the following program in Basic.

```
10 SOUND 0, 100, 10, 15: GOTO 10
```

Check for pulses at pin 37 of the POKEY IC (U22). If pulses are missing check IC U22. If pulses are present at pin 37, check the waveform at pin 1 of the Audio Amp IC (U1), see Figure 1. If the waveform is missing check the voltages and components associated with pins 1 thru 8 of IC U1. If the waveform is present at pin 1 of IC U1 check the adjustment of the Sound Coil (L202) on the RF Modulator and check the RF Modulator.



Figure 1

If there is sound when running the above program, but there is no clicking sound when a key is pressed, check for pulses at pin 15 of the GTIA IC (U17) while pressing a key. If pulses are missing check IC U17. If pulses are present check Capacitor C23 and Resistor R5.

Sound works when RF modulator is used, but not when using a Video/Audio Monitor connected to Jack J2. Check the connections at Jack J2 and check Resistors R8 and R10.

Sound works when above program is run, but not when the audio input of Jack J9 pin 49 is used. Check Electrolytic C22.

Sound works when above program is run, but not when the audio input of Jack J1 pin 11 is used. Check Electrolytic C19 and Capacitor C110.

TROUBLESHOOTING (Continued)

KEYBOARD

If the keyboard is dead, check connector J8 for good connections and check the ribbon cable for defects. If the connector and cable check good, check the waveforms at pins 18 thru 23 of the POKEY IC (U22). If the waveforms are missing, check IC U22. If the waveforms are present at pins 18 thru 23 of IC U22, check the waveform at pin 3 of the Keyboard Multiplexer IC (U24) while pressing any key except the Shift, Control, Break or Function keys. If the waveform is missing at pin 3 of IC U24 check IC's U24 and U25. If the waveform is present at pin 3 of IC U24 check the GTIA IC (U17) and IC U22.

If the Start, Select or Option keys do not work, check the logic readings at pins 12, 13 and 14 of IC U17. Pin 12 should read logic Low when the Start key is pressed, pin 13 should read logic Low when the Select key is pressed and pin 14 should read logic Low when the Option key is pressed. If the logic readings are correct check IC U17. If the logic readings are not correct check the keyboard connector J8, ribbon cable and Resistors R134, R135 and R136.

If the Shift, Control or Break keys do not work, check the waveform at pin 16 of IC U22 while pressing the Shift, Control or Break keys. If the waveform is present, check IC U22. If the waveform is missing at pin 16 of IC U22, check for the same waveform at pin 5 of Keyboard Multiplexer IC (U25) while pressing the Shift, Control or Break keys. If the waveform is missing, check IC U25. If the waveform is present at pin 5 of IC U25, check Resistors R96, R137 and RN14 and check pins 9 and 8 of connector J8 for good connections.

If there is no clicking sound when a key is pressed, check for pulses at pin 15 of IC U17 while pressing a key. If pulses are missing, check IC U17. If pulses are present, check Capacitor C23 and Resistor R5.

If one key is erratic, clean the key.

If characters come up wrong on the Monitor screen when a key is pressed, check IC's U7, U17 and U22.

If one key or group of keys does not work, use the following chart to determine which pins of Connector J8 the bad keys connect to and use an ohmmeter to check the keys for continuity, each key should measure about 55 ohms. If the keys check good, turn the Computer On and use a scope to check for pulses at connector J8 while pressing the bad keys. Note: A logic probe may indicate pulses even when no key is pressed.

J8	(Connect to IC U24)
PIN	KEYS

10	6, 7, Y, U, N
11	H, J, SPACE
13	4, 9, R, O, F, L, V, ,
14	3, 0, E, P, D, ;, C, .
17	ESC, BACKS, TAB, RETURN, CAPS
16	1, >, Q, =, A, *, Z, □
15	2, <, W, -, S, +, X, /
12	5, 8, T, I, G, K, B, M

J8	(Connect to IC U25)
PIN	KEYS

2	ESC, 1, 2, 3, 4, 5, 6
3	U, I, O, P, -, =, RETURN
5	J, K, L, ;, +, *, CTRL
8	SHIFT, Z, X, C, V, B
7	N, M, ,, /, □, SPACE
6	A, S, D, F, G, H, LOWR
1	BREAK, 7, 8, 9, 0, <, >, BACKS
4	TAB, Q, W, E, R, T, Y

If pulses are missing check the Resistors or Resistor Network that connect connector J8 to IC's U24 and U25 and check IC's U24 and U25.

CASSETTE SAVE AND LOAD

Computer will not save a program on tape. Type a program or load an existing program into the Computer. Save the program back on tape, see "Cassette Operation" section of the General Operating Instructions. While saving the program, check the waveforms on pins 26, 27 and 28 of the POKEY IC (U22). If any of the waveforms are missing, check IC U22 by substitution. If the waveforms are correct, check the connections at pins 1, 2, and 5 of Jack J1.

Computer will not load a program from tape. Check for pulses at pin 24 of IC U22 while loading a program from tape, see "Cassette Operation" section of the General Operating Instructions. If the pulses are present, check the connections at pin 3 of Jack J1.

Recorder motor will not start when saving or loading a program. Type POKE 54018,52 and press the RETURN key. Check the logic probe reading on pin 39 of the PIA IC (U23). The reading should go from High to Low to start the recorder motor. If the reading stays High, check IC U23 by substitution. If the reading operates normally, check Switch Transistor (Q7) and check the connections at pin 8 of Jack J1. To turn the recorder motor Off, type POKE 54018,60 and press RETURN key.

PADDLES

The following Basic program can be used to check the operation of the paddles.

```

10 PRINT, "PADDLE", "BUTTON"
20 FOR P= 0 TO 3
30 PRINT "PADDLE"; P, PADDLE (P), PTRIG (P)
40 NEXT P
50 FOR T= 1 TO 200: NEXT T
60 PRINT: GOTO 10

```

On the Monitor screen the number under PADDLE should vary from 228 to 1 as the paddle is varied from MINIMUM to Maximum. The number 1 under BUTTON should change to 0 when the button is pressed.

If a paddle does not function, use the following chart to determine which pin of the POKEY IC (U22) the paddle is connected to and check the waveform on the pin.

TROUBLESHOOTING (Continued)

PORT	PADDLE	U22 PIN	BUTTON	U23 PIN
1	0	14	0	4
1	1	15	1	5
2	2	12	2	8
2	3	13	3	9

The waveform should vary from the sawtooth waveform shown in Figure 2 to the pulse waveform shown in Figure 3. If the waveform is missing, check the port connector, the paddle control and check IC U22 by substitution. If a button is not functioning, use the chart to determine which pin the button is connected to and use a logic probe to check the pin while the button is pressed. The logic probe reading should go from High to Low when the button is pressed. If the reading does not go Low, check the button switch and the port connector. If the logic reading is correct, check the PIA IC (U23) by substitution.

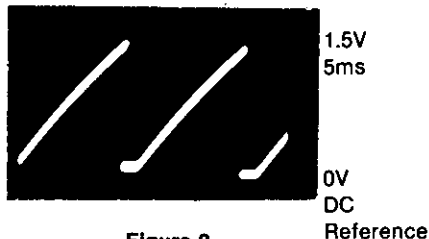

Figure 2

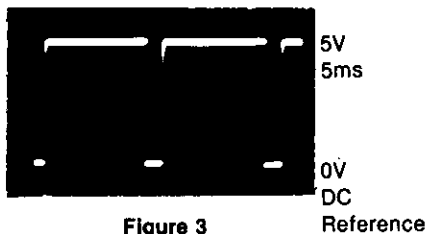

Figure 3

JOYSTICK PORT

The following Basic program can be used to check the operation of the joystick ports. Plug a joystick into the port being tested, type in and run the program.

```

10 PRINT, "JOYSTICK", "BUTTON"
20 FOR P=0 TO 1
30 PRINT "PORT"; P+1, STICK (P), STRIG (P)
40 NEXT P
50 FOR T=1 TO 200: NEXT T'
60 GOTO 10
    
```

On the Monitor screen the number 1 under BUTTON should change to 0 when the button is pressed. The number 15 under JOYSTICK should change to the following for each position of the joystick:

UP 14	LEFT 11
DOWN 13	RIGHT 17

If the joystick is not working properly, check the logic readings on the PIA IC (U23) and GTIA IC (U17) pins that are used for the Joysticks. Use the following chart to determine which pin is affected by each joystick function.

JOYSTICK	PORT 1 IC	PIN	PORT 2 IC	PIN
UP	U23	2	U23	6
DOWN	U23	3	U23	7
LEFT	U23	4	U23	8
RIGHT	U23	5	U23	9
BUTTON	U17	8	U17	9

The logic reading should go from High to Low when each function of the joystick is used. If the logic readings are correct, check IC U17 if the button is not working, and check IC U23 if the position functions are not working. If the logic reading is not correct check the components connected to the pin with the incorrect reading and check connectors J5 or J6 for good connections.

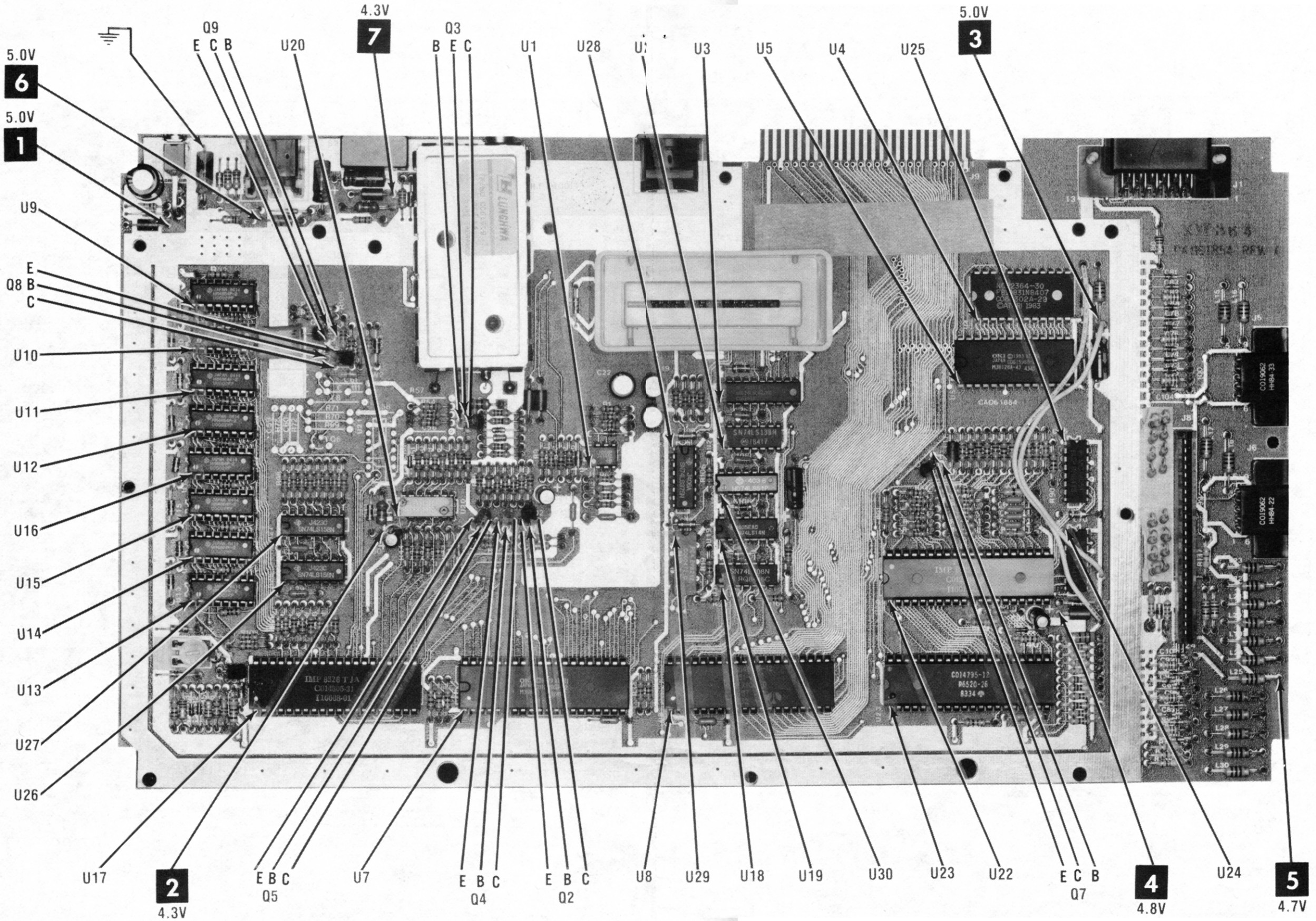

ARROWS ON IC'S INDICATE PIN 1 UNLESS NOTED

GridTrace LOCATION GUIDE

C1	B-1	C81	D-27	Q8	F-6	R79	H-23	RN23	G-26
C2	A-3	C82	D-27	Q9	E-6	R80	K-17	RN24	H-26
C3	B-5	C83	D-27	R1	G-13	R81	J-21	RN31	K-26
C4	B-3	C84	E-27	R2	H-13	R82	J-21	RN32	K-26
C5	B-3	C85	O-27	R3	G-13	R83	J-21	RN33	J-26
C6	B-5	C86	O-27	R4	J-13	R84	J-21	RN34	J-26
C7	B-7	C87	O-27	R5	I-13	R85	I-20	RN41	K-26
C8	B-1	C88	N-27	R6	I-13	R86	O-22	RN42	K-26
C9	B-3	C89	N-27	R7	I-13	R87	I-20	RN43	J-26
C10	B-7	C90	N-27	R8	H-12	R88	J-20	RN44	J-26
C11	B-1	C91	N-27	R9	H-11	R89	J-23	S1	A-2
C12	B-4	C92	M-27	R10	H-11	R90	I-24	S2	A-7
C13	B-8	C93	L-26	R11	H-11	R91	J-20	U1	H-12
C14	C-3	C94	L-27	R12	G-15	R92	J-20	U2	H-16
C15	B-8	C95	L-28	R13	G-14	R93	J-20	U3	G-16
C16	H-12	C96	N-27	R14	G-15	R94	J-20	U4	D-22
C17	J-13	C97	O-27	R15	G-15	R95	L-27	U5	F-22
C18	E-12	C98	L-23	R16	L-17	R96	L-26	U7	N-11
C19	G-14	C102	M-27	R19	K-15	R97	K-10	U8	N-16
C20	G-14	C105	H-15	R20	L-15	R98	I-5	U9	D-3
C21	H-13	C106	J-16	R21	N-9	R99	I-5	U10	E-3
C22	G-13	C107	J-15	R22	N-14	R100	I-5	U11	G-3
C23	J-12	C108	H-16	R23	M-5	R101	I-6	U12	H-3
C24	I-11	C109	F-7	R24	M-5	R102	I-5	U13	L-3
C25	G-16	C110	A-26	R25	M-5	R103	I-6	U14	K-3
C26	F-16	CR1	M-23	R26	M-4	R104	I-5	U15	J-3
C27	E-24	CR2	O-3	R27	M-4	R105	I-6	U16	I-3
C28	F-24	CR3	O-2	R28	M-5	R106	I-15	U17	N-6
C29	L-5	CR4	I-8	R29	M-6	R107	M-4	U18	K-16
C30	O-13	J1	A-27	R30	M-6	R108	M-4	U19	J-16
C31	O-15	J2	A-14	R31	N-8	R109	E-6	U20	J-8
C32	K-5	J3	A-10	R32	D-3	R110	F-6	U22	K-20
C34	E-2	J4	E-16	R33	N-8	R111	E-5	U23	N-20
C35	F-2	J5	F-29	R34	N-13	R112	F-6	U24	K-24
C36	G-2	J6	I-29	R35	O-3	R113	E-5	U25	H-24
C37	H-2	J7	A-4	R36	O-3	R114	F-7	U26	K-5
C38	L-2	J8	H-27	R37	O-2	R116	I-9	U27	J-5
C39	K-2	J9	A-19	R38	M-2	R117	H-22	U28	I-15
C40	J-2	L1	C-1	R39	L-22	R118	H-21	U29	K-15
C41	I-2	L2	C-5	R40	M-23	R119	H-22	U30	I-16
C42	N-4	L3	B-7	R41	K-8	R120	O-24	W1	I-23
C43	K-16	L4	B-7	R42	K-8	R121	N-24	W2	F-6
C44	O-3	L5	J-7	R43	K-8	R122	N-24	Y1	F-6
C45	O-3	L6	G-9	R44	K-8	R123	N-24		
C46	O-2	L7	G-11	R45	K-9	R124	N-24		
C47	N-2	L9	G-11	R46	I-9	R125	M-24		
C48	M-2	L10	D-25	R47	I-9	R126	M-24		
C49	I-17	L11	H-21	R48	I-9	R127	M-24		
C50	J-7	L12	L-24	R49	I-8	R128	H-23		
C51	J-7	L14	M-24	R50	I-8	R129	H-22		
C52	K-9	L15	E-28	R51	I-8	R130	H-22		
C53	K-11	L16	E-28	R52	H-8	R131	H-22		
C54	H-10	L17	H-27	R53	G-8	R132	O-24		
C55	H-10	L18	I-28	R54	G-8	R133	N-24		
C62	K-22	L19	M-29	R55	G-10	R134	P-27		
C63	J-23	L20	L-29	R56	G-10	R135	P-27		
C64	J-23	L21	L-29	R58	I-10	R136	P-27		
C65	J-23	L22	L-29	R59	I-10	R137	K-27		
C66	I-23	L23	K-29	R60	I-11	R140	E-3		
C68	O-23	L24	M-29	R61	I-10	R141	F-3		
C69	L-24	L25	N-29	R62	J-11	R142	G-3		
C70	J-24	L26	N-28	R63	I-10	R143	H-3		
C71	G-27	L27	O-28	R64	J-10	R144	L-3		
C72	F-27	L28	O-28	R65	I-10	R145	K-3		
C73	F-27	L29	P-28	R66	I-9	R146	J-3		
C74	F-27	L30	P-28	R67	H-10	R147	I-3		
C75	F-27	Q1	N-3	R68	H-10	RN11	H-26		
C76	E-27	Q2	J-11	R74	I-21	RN12	H-26		
C77	E-27	Q3	H-9	R75	I-21	RN13	H-26		
C78	E-27	Q4	J-10	R76	H-23	RN14	I-26		
C79	F-25	Q5	J-10	R77	H-23	RN21	H-26		
C80	C-26	Q7	I-21	R78	H-23	RN22	I-26		

SAFETY PRECAUTIONS

1. Use an isolation transformer for servicing.
2. Maintain AC line voltage at rated input.
3. Remove power from the Computer before servicing or installing electrostatically sensitive devices. Examples of typical ES devices are integrated circuits and semiconductor "chip" components.
4. Use extreme caution when handling the printed circuit boards. Some semiconductor devices can be damaged easily by static electricity. Drain off any electrostatic charge on your body by touching a known earth ground. Wear a commercially available discharging wrist strap device. This should be removed prior to applying power to the unit under test.
5. Use a grounded-tip, low voltage soldering iron.
6. Use an isolation (times 10) probe on scope.
7. Do not remove or install boards, floppy disk drives, printers, or other peripherals with power On.
8. Do not use freon-propelled sprays. These can generate electrical charges sufficient to damage semiconductor devices.
9. The Computer cabinet is equipped with vents to prevent heat build-up. Never block, cover, or obstruct these vents.
10. Instructions should be given, especially to children, that objects should not be dropped or pushed into the vents of the cabinet. This could cause shock or equipment damage.
11. Never expose the Computer to water. If exposed to water, turn the unit Off. Do not place the Computer near possible water sources.
12. Never leave the Computer unattended or plugged into the AC outlet for long periods of time. Remove AC plug from AC outlet during lightning storms.
13. Never use liquids or aerosols directly on the Computer. Spray on cloth and then apply to the Computer cabinet. Make sure the Computer is disconnected from the power line.

SCHMATIC NOTES

- *— Circuitry not used in some versions
- Circuitry used in some versions
- See parts list
- ⊕ Ground

Waveforms and voltages taken from ground, unless noted otherwise.

Voltages, Waveforms and Logic probe readings taken with computer turned On, no keys pressed, unless otherwise noted.

Waveforms taken with triggered scope and Sweep/Time switch in Calibrate position, scope input set for DC coupling on 0 reference voltage waveforms. Switch to AC input to view waveforms after DC reference is measured when necessary. Each waveform is 7 cm. width with DC reference voltage given at the bottom line of each waveform.

Time in $\mu\text{sec.}$ per cm, given with p-p reading at the end of each waveform.

Item numbers in rectangles appear in the alignment/adjustment instructions.

Supply voltages maintained as shown at input.

Voltages measured with digital meter, no signal.

Controls adjusted for normal operation.

Terminal identification may not be found on unit.

Capacitors are 50 volts or less, 5% unless noted.

Electrolytic capacitors are 50 volts or less, 20% unless noted.

Resistors are $\frac{1}{2}W$ or less, 5% unless noted.

Value in () used in some versions.

Measurements with switching as shown, unless noted.

Logic Probe Display

L = Low

H = High

P = Pulse

* = Open (No light On)

PARTS LIST AND DESCRIPTION

When ordering parts, state Model, Part Number, and Description

SEMICONDUCTORS (Select replacement transistor for best results)

ITEM No.	TYPE No.	MFRG. PART No.	REPLACEMENT DATA					
			GENERAL ELECTRIC PART No.	NTE PART No.	ECG PART No.	RCA PART No.	WORKMAN PART No.	ZENITH PART No.
CR1 thru CR5	1N4148	C060607	GE-514	NTE519	ECG519	SK3100/519	WEP925/519	103-131
Q1 thru Q5	2N3904	34-2N3904	GE-123AP	NTE123AP	ECG123AP	SK3854/123AP	WEP736/123A	121-Z9000A
Q7	MPSA55	C014809	GE-82	NTE159	ECG159	SK3466/159	WEP62/159	121-Z9003
Q8,9	2N3906	C018991	GE-82	NTE159	ECG159	SK3466/159	WEP62/159	121-Z9003
U1	LM358P	C061702		NTE928M	ECG928M	SK3692/928M		
U2	SN74LS138N	C061428	74LS138	NTE74LS138	ECG74LS138	SK74LS138		HE-443-877
U3	NML16L8LNJ/NC	C061618						
U4	NCR2364-30	C060302						
U5	M38128A-43	C060302A-29(1) C061598 C061598B-22(1)						
U7		C021697						
U8	6502C (3)	C012296D-22(1) C014806 C014806-12(1)						
U9 thru U16	HM4864P-2	C060612	4164-15	NTE4164	ECG2164			
U17	110008-01	C014805 C014805-31(1)						
U18	SN74LS08N	C017097	74LS08	NTE74LS08	ECG74LS08	SK74LS08		HE-443-780
U19	SN74LS14N	C061850	74LS14	NTE74LS14	ECG74LS14	SK74LS14		HE-443-872
U20	CD4050BE	C010816	GE-4050	NTE4050B	ECG4050B	SK4050B		221-Z9163
U21	74LS74	(2)	74LS74A	NTE74LS74A	ECG74LS74A	SK74LS74A		HE-443-730
U22	110010-01	C012294 C012294-31(1)						
U23	R6520E R6520-26 6520A	C014795-12(1) C014795						

PARTS LIST AND DESCRIPTION (Continued)

When ordering parts, state Model, Part Number, and Description

SEMICONDUCTORS (Select replacement transistor for best results)

ITEM No.	TYPE No.	MFG. PART No.	REPLACEMENT DATA					
			GENERAL ELECTRIC PART No.	NTE PART No.	ECG PART No.	RCA PART No.	WORKMAN PART No.	ZENITH PART No.
U24,25	MC14051BCP CD4051B	C014336	GE-4051	NTE4051B	ECG4051B	SK4051B		905-380
U26,27	SN74LS158N	C014345	GE-4051	NTE4051B	ECG4051B	SK4051B		905-380
U28	SN74LS375N	C060619	74LS158	NTE74LS158	ECG74LS158			
U30	HD74LS51P	C060474	74LS375 74LS51	NTE74LS51	ECG74LS51	SK74LS51		

(1) Number on unit.

(2) Used In United Kingdom.

(3) Modified.

WIRING DATA

Shielded Hook-up Wire	Use BELDEN No. 8401 or 8421 (Single-Conductor) 8208 (Two-Conductor)
General-use Unshielded Hook-up Wire	Use BELDEN No. 8529 (Solid) Available in 13 Colors 8522 (Stranded) Available in 13 Colors
300-Ohm Input Lead	Use BELDEN No. 8225
75-Ohm Input Lead	Use BELDEN No. 8241

PARTS LIST AND DESCRIPTION (Continued)

When ordering parts, state Model, Part Number, and Description

ELECTROLYTIC CAPACITORS

ITEM No.	RATING	MFGR. PART No.
C19	4.7 35V NP	C061647
C20	4.7 35V NP	C061647

ITEM No.	RATING	MFGR. PART No.
C22	4.7 35V NP	C061647

For SAFETY use only equivalent replacement part.
Items not listed normally available at local distributors.

CAPACITORS

ITEM No.	RATING	MFGR. PART No.
C44	68 NPO 50V 5%	C014179-12

ITEM No.	RATING	MFGR. PART No.
C53	3.9pF NPO 50V 10%	C061336-01

Items not listed normally available at local distributors.

RESISTORS (Power and Special)

ITEM No.	RATING	REPLACEMENT DATA		
		MFGR. PART No.	NTE PART No.	WORKMAN PART No.
RN1	Resistor Network (2)	C061668-04 (1)		
RN2	Resistor Network (3)	C061668-04 (1)		
RN3	Resistor Network (4)	C061668-04 (1)		
RN4	Resistor Network (5)	C061668-04 (1)		

- (1) Contains four 470.
- (2) Composed of RN11, RN12, RN13, RN14.
- (3) Composed of RN21, RN22, RN23, RN24.
- (4) Composed of RN31, RN32, RN33, RN34.
- (5) Composed of RN41, RN42, RN43, RN44.

CONTROLS (All wattages 1/2 watt, or less, unless listed)

ITEM NO.	FUNCTION	RESISTANCE	MFGR. PART NO.	NOTES
R38	Color	500K	19-411504	

COILS (RF-IF)

ITEM No.	FUNCTION	MFGR. PART No.
L4 & L5	RF Choke (820uH)	C017948-03
L6	RF Choke (100uH)	C017948-04
L8	RF Choke (1)	
L10	RF Choke (10uH)	C014381

ITEM No.	FUNCTION	MFGR. PART No.
L14	RF Choke (22uH)	C014380
L15 Thru L30	RF Choke (10uH)	C014381

(1) Used In United Kingdom models.

PARTS LIST AND DESCRIPTION (Continued)

When ordering parts, state Model, Part Number, and Description

MISCELLANEOUS

ITEM No.	PART NAME	MFGR. PART No.	NOTES
L1,L2 L3,L7 L9,L11, L12	Ferrite Bead	C014384	
S1	Switch	C061022	Power
S2	Switch	C019702-01	Channel Select
U29	Delay Line	C060472	
Y1	Crystal	C061090	3.58MHz
Y2	Crystal		4.33618MHz United Kingdom Models
	Keyboard	C061983	
	Power Supply	CA024814-001	
	RF Modulator	CA061619 REV 1A	
	TV Switchbox	CA014746	

CABINETS & CABINET PARTS (When ordering specify model, chassis & color)

ITEM	PART No.
Door, Cartridge	C024582-001

ITEM	PART No.
Spring, Door	C024681-001

LINE DEFINITIONS

O2	Phase 2 Clock
O0	Phase 0 Clock
A0 thru A15	Address
A POT (1)	Potentiometer A (Joystick 1)
A POT (2)	Potentiometer A (Joystick 2)
AUDIO IN	Audio In
AUDIO OUT	Audio Out
B02	Gated Phase 2 Clock
BACK (1)	Back (Joystick 1)
BACK (2)	Back (Joystick 2)
B POT (1)	Potentiometer B (Controller 1)
B POT (2)	Potentiometer B (Controller 2)
CADJ	Color Delay
CAS	Column Address Strobe
CCTL	
CLOCK IN	Clock Input
CLOCK OUT	Clock Output
COMMAND	Command
CS	
CS0	
CS2	
D0 thru D7	Data
DATA IN	Data Input
DATA OUT	Data Output
EXTEN B	
EXTSEL	External Select
FWD (1)	Forward (Joystick 1)
FWD (2)	Forward (Joystick 2)
HALT	Halt
INTERRUPT	Interrupt
IRQ	Interrupt Request
LEFT (1)	Left (Joystick 1)
LEFT (2)	Left (Joystick 2)
LR/W	Latch Read/Write
MOTOR CONTROL	Cassette/Disk Motor Control
MPD	Math Pack Disable
NMI	Non Maskable Interrupt
PB0	
PB1	
PB7	
PROCEED	Proceed
R/W	Read/Write
RAS	Row Address Strobe
RD4	
RD5	
RDY	Ready
REF	Refresh
RIGHT (1)	Right (Joystick 1)
RIGHT (2)	Right (Joystick 2)
RST	Reset
RST SW	Reset Switch
S0	
S1	
S2	
S3	
S4	
S5	
TRIGGER (1)	Trigger (Joystick 1)
TRIGGER (2)	Trigger (Joystick 2)

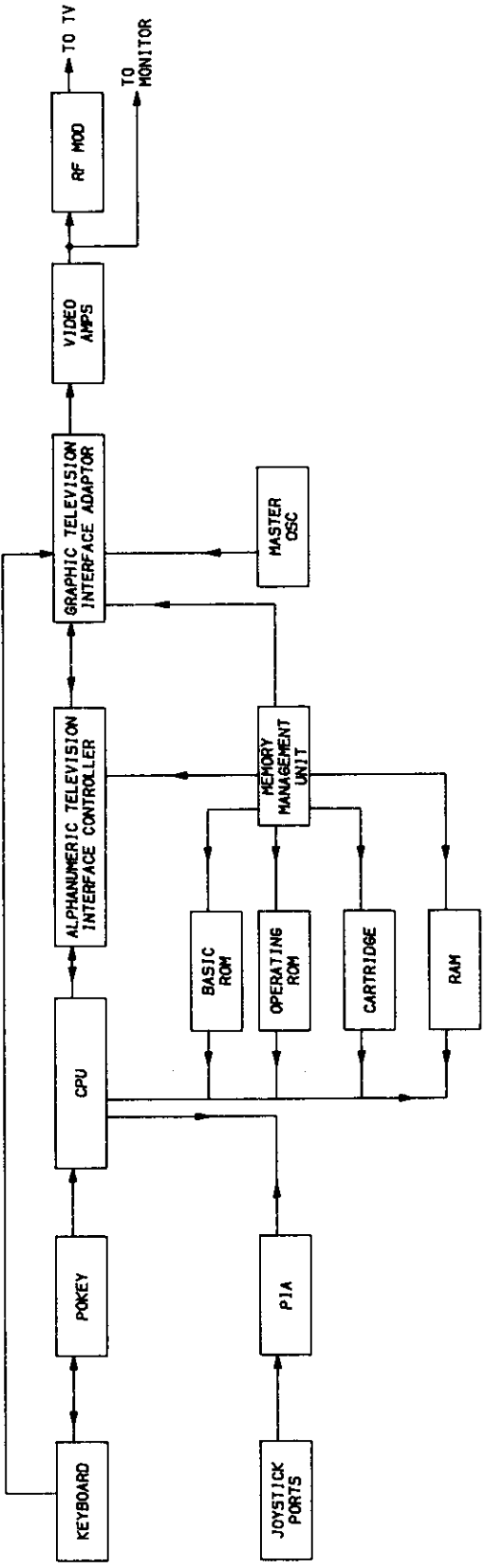

BLOCK DIAGRAM

LOGIC CHART

PIN NO.	IC U2	IC U3	PIN NO.	IC U4	PIN NO.	IC U4	PIN NO.	IC U5	PIN NO.	IC U5	PIN NO.	IC U7	PIN NO.	IC U7
1	P	P	1	P	13	P	1	H	17	P	1	L	21	H
2	P	P	2	P	14	P	2	P	18	P	2	P	22	P
3	P	P	3	P	15	P	3	P	19	P	3	P	23	P
4	P	P	4	P	16	P	4	P	20	P	4	H	24	P
5	L	P	5	P	17	P	5	P	21	P	5	P	25	P
6	H	H	6	P	18	P	6	P	22	P	6	H	26	P
7	H	L	7	P	19	P	7	P	23	P	7	P	27	P
8	L	L	8	P	20	H	8	P	24	P	8	P	28	P
9	H	H	9	P	21	P	9	P	25	P	9	P	29	P
10	P	L	10	P	22	P	10	P	26	P	10	P	30	P
11	P	P	11	P	23	H	11	P	27	H	11	P	31	P
12	P	H	12	L	24	H	12	P	28	H	12	P	32	P
13	P	H					13	P			13	P	33	P
14	P	H					14	L			14	P	34	P
15	P	P					15	P			15	H	35	P
16	H	P					16	P			16	P	36	H
17		P									17	P	37	P
18		L									18	P	38	P
19		H									19	P	39	P
20		H									20	P	40	P
PIN NO.	IC U8	PIN NO.	IC U8	PIN NO.	IC U9	IC U10	IC U11	IC U12	IC U13	IC U14	IC U15	IC U16		
1	L	21	L	1	H	H	H	H	H	H	H	H		
2	H	22	P	2	P	P	P	P	P	P	P	P		
3	P	23	P	3	P	P	P	P	P	P	P	P		
4	H	24	P	4	P	P	P	P	P	P	P	P		
5	*	25	P	5	P	P	P	P	P	P	P	P		
6	P	26	P	6	P	P	P	P	P	P	P	P		
7	P	27	P	7	P	P	P	P	P	P	P	P		
8	H	28	P	8	H	H	H	H	H	H	H	H		
9	P	29	P	9	P	P	P	P	P	P	P	P		
10	P	30	P	10	P	P	P	P	P	P	P	P		
11	P	31	P	11	P	P	P	P	P	P	P	P		
12	P	32	P	12	P	P	P	P	P	P	P	P		
13	P	33	P	13	P	P	P	P	P	P	P	P		
14	P	34	*	14	P	P	P	P	P	P	P	P		
15	P	35	P	15	P	P	P	P	P	P	P	P		
16	P	36	P	16	L	L	L	L	L	L	L	L		
17	P	37	P											
18	P	38	L											
19	P	39	P											
20	P	40	H											

Logic Probe Display
 L = Low
 H = High
 P = Pulse
 * = Open (No light On)

Note: Logic probe readings taken with computer turned On, no keys pressed, unless otherwise noted.

MISCELLANEOUS ADJUSTMENTS

COLOR

Turn the Computer On and adjust the Color Control (R38) for a blue screen on the Monitor.

RF MODULATOR

CHANNEL ADJUST

Set TV on channel 2 or 3 with the AFC off. Set the Computer Channel Switch (S2) to the same channel and adjust the Channel Coil (L201) for the best picture.

SOUND ADJUST

Type in and run the following program in Basic.

```
10 SOUND 0, 100, 10, 15: GOTO 10
```

Adjust the Sound Coil (L202) for maximum sound with minimum noise.

DISASSEMBLY INSTRUCTIONS

CABINET REMOVAL

Remove six screws from cabinet bottom. Lift cabinet top up and disconnect keyboard cable. Cabinet top may now be removed.

MAIN BOARD REMOVAL

Remove four screws holding PC board to cabinet bottom. Lift PC board and metal shield from cabinet bottom. To remove shield, remove ten screws holding shield together and remove shield from main board.

GENERAL OPERATING INSTRUCTIONS

POWER UP

The Computer will come up ready to program in Basic when the Computer is turned On.

For instructions on loading and saving programs with an Atari Recorder see the "Cassette Operation" section.

To run a program type RUN and press the RETURN key. To stop a program, press the BREAK key or press the system RESET key.

CASSETTE OPERATION

Connect the Atari Program Recorder to the connector on the right side of the Computer. NOTE: A standard tape recorder will not work with this Computer.

To load a program, type CLOAD and press the RETURN key. The speaker will beep once. After the speaker beeps, push the PLAY button on the Recorder and press the RETURN key again. The program will then load. The word READY on the screen indicates the loading is completed. The Recorder will shut-off automatically.

To save a program, type CSAVE and press the RETURN key. The speaker will beep twice. After the speaker beeps, press the PLAY and RECORD buttons on the Recorder and then press the RETURN key. The program will then save. The word READY on the screen indicates the program has been saved. The Recorder will shut-off automatically.

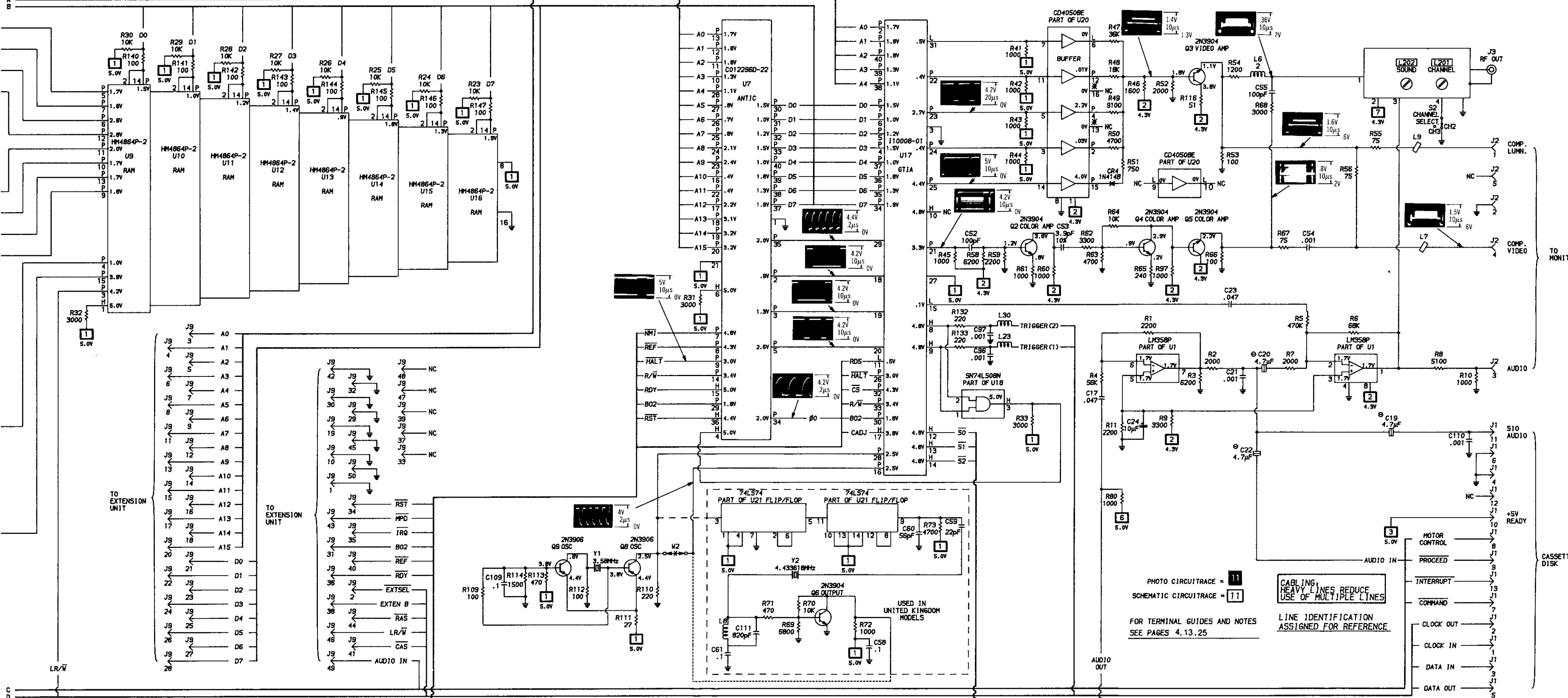

A PHOTOFAC STANDARD NOTATION SCHEMATIC WITH CIRCUITRACE

PRELIMINARY SERVICE CHECKS

This data provides the user with a time-saving service tool which is designed for quick isolation and repair of Computer malfunctions.

Check all interconnecting cables for good connection and correct hookup before making service checks.

Disconnect all peripherals except the Monitor from the Computer to eliminate possible external malfunctions.

Replacement or repair of the power supply, main board, keyboard, or connectors may be necessary after the malfunction has been isolated.

TEST EQUIPMENT AND TOOLS

TEST EQUIPMENT

Digital Volt/Ohm Meter

TOOLS

Low Wattage Soldering Iron
Desoldering Equipment
Switch Cleaner (non spray type)
Phillips Screwdriver
Flat Blade Screwdriver
IC Insertion and Removal Tools 16, and 40 pin
Alignment Tools GC Electronics 9440

REPLACEMENT PARTS AND DESCRIPTION

IDENT	PART NO.	DESCRIPTION
S1	C061022	Switch, Power
U7	C021697	IC, ANTIC
U8	C014806	IC, CPU
U9	C060612	IC, RAM
thru U16		
U17	C0014805	IC, GTIA
U22	C012294	IC, Pokey

PRELIMINARY SERVICE CHECKS (Continued)

SERVICE CHECKS

SEE INTERCONNECTING DIAGRAM AND PHOTOS TO MATCH THE NUMBER IN THE CIRCLES WITH THOSE IN THE FOLLOWING DATA FOR SERVICE CHECKS TO BE PERFORMED.

① COMPUTER DEAD

- (A) Unplug the Power Pack and check for 5.0V from pin 3 to pin 1 of Plug P7. If 5.0V is missing, check Plug P7 and the cable for possible open circuits. If the Power Pack is bad, check for a possible short from pin 3 to pin 1 of Jack J7 with the Power Switch (S1) in the On position. If a short exists Do Not plug in a new power pack until the short is repaired.
- (B) If the Power Pack is good, turn the Computer On and check for 5.0V on the positive end of Electrolytic C2. If 5.0V is missing, check the Power Switch (S1).

② COMPUTER DOES NOT COME UP PROPERLY

- (A) Check the CPU IC (U8), GTIA IC (U17), POKEY IC (U22), ANTIC IC (U7) and RAM IC's U9 thru U16.

③ VIDEO

- (A) No video. If RF Modulator output is being used check the Channel Switch (S2) for correct channel and check the Channel Adjust Coil (L201). See "Miscellaneous Adjustments". Also check the ANTIC IC (U7) and GTIA IC (U17).

④ COLOR

- (A) Color not correct or no color. Check the adjustment of the Color Control (R38) and the Channel Adjust Coil (L201). See "Miscellaneous Adjustments" and check the ANTIC IC (U7) and GTIA IC (U17).

⑤ SYNC

- (A) No vertical or horizontal sync. Check GTIA IC (U17).

⑥ KEYBOARD

- (A) No clicking sound when a key is pressed. Check GTIA IC (U17).
- (B) Keyboard is dead. Check the IC U17 and POKEY IC (U22).
- (C) One key is erratic. Clean the key.
- (D) One group of keys does not work. Check IC U22.
- (E) START, SELECT or OPTION Function keys or SHIFT, CONTROL and BREAK keys do not work. Check IC U17.
- (F) Wrong characters appear on the Monitor Screen when the key is pressed. Check the ANTIC IC (U7), and IC's U17 and U22.

⑦ SOUND

- (A) No sound. Check the adjustment of the Sound Adjust Coil (L202). See "Miscellaneous Adjustments" and check IC U22.

⑧ CASSETTE

- (A) Cassette motor will not start. Check PIA IC (U23).
- (B) Cassette save or load does not work. Check POKEY IC (U22).

⑨ JOYSTICKS

- (A) Joystick button does not work. Check GTIA IC (U17).
- (B) Joystick position functions do not work. Check PIA IC (U23).

⑩ PADDLES

- (A) Paddle button does not work. Check PIA IC (U23).
- (B) Paddle control does not work. Check POKEY IC (U22).

PRELIMINARY SERVICE CHECKS (Continued)

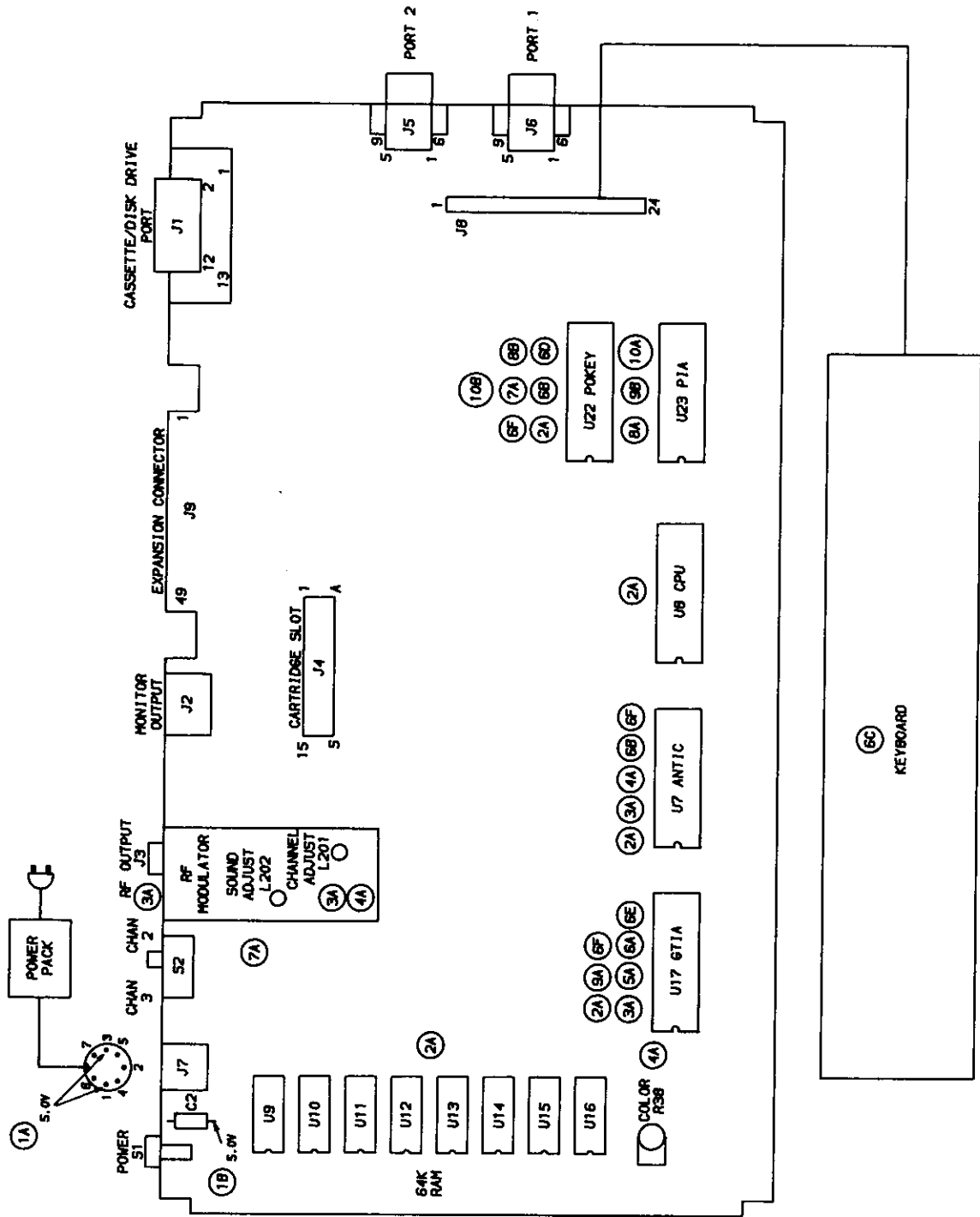

CC-11
ATARI
MODEL 800XL

INTERCONNECTING DIAGRAM

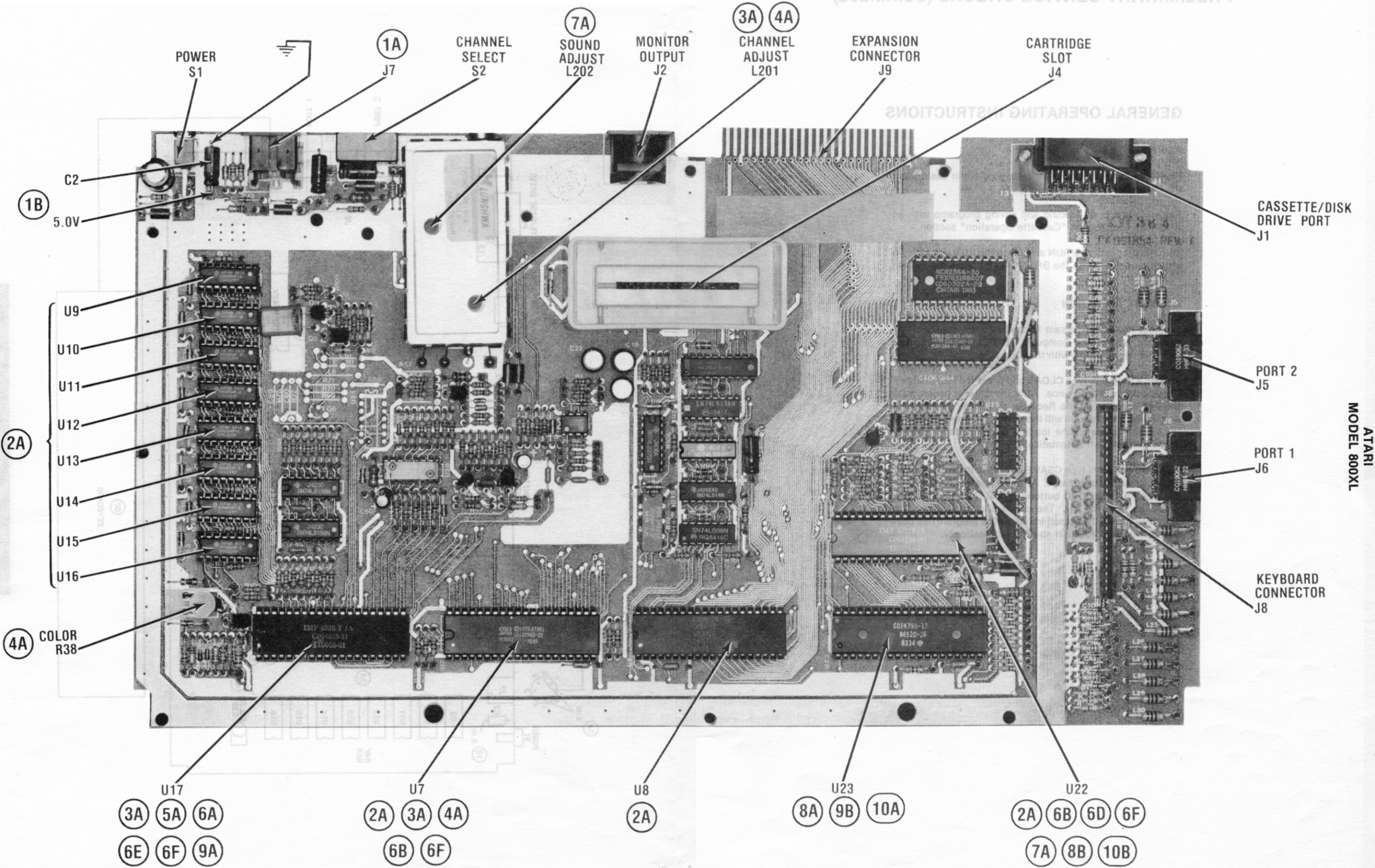

POWER
S1

1B

5.0V

C2

1A

J7

CHANNEL
SELECT
S2

7A

SOUND
ADJUST
L202

MONITOR
OUTPUT
J2

3A

CHANNEL
ADJUST
L201

4A

EXPANSION
CONNECTOR
J9

CARTRIDGE
SLOT
J4

CASSETTE/DISK
DRIVE PORT
J1

PORT 2
J5

PORT 1
J6

KEYBOARD
CONNECTOR
J8

ATARI
MODEL 800XL

U9

U10

U11

U12

U13

U14

U15

U16

2A

4A

COLOR
R38

U17

3A 5A 6A

6E 6F 9A

U7

2A 3A 4A

6B 6F

U8

2A

U23

8A 9B 10A

U22

2A 6B 6D 6F

7A 8B 10B

GENERAL OPERATING INSTRUCTIONS

ATARI 800XL REV. 1

NCR2364-30
F810831N8407
C060502A-29
ATARI 1983

ONCE © 1979 ATARI
3741 5138H
© 1981

SN74LS158N
© 1984

SN74LS158N
© 1984

SN74LS158N
© 1984

SN74LS158N
© 1984

SN74LS158N
© 1984

SN74LS158N
© 1984

SN74LS158N
© 1984

SN74LS158N
© 1984

SN74LS158N
© 1984

SN74LS158N
© 1984

SN74LS158N
© 1984

SN74LS158N
© 1984

PRELIMINARY SERVICE CHECKS (Continued)

GENERAL OPERATING INSTRUCTIONS

POWER UP

The Computer will come up ready to program in Basic when the Computer is turned On.

For instructions on loading and saving programs with an Atari Recorder see the "Cassette Operation" section.

To run a program type RUN and press the RETURN key. To stop a program, press the BREAK key or press the system RESET key.

CASSETTE OPERATION

Connect the Atari Program Recorder to the connector on the right side of the Computer. NOTE: A standard tape recorder will not work with this Computer.

To load a program, type CLOAD and press the RETURN key. The speaker will beep once. After the speaker beeps, push the PLAY button on the Recorder and press the RETURN key again. The program will then load. The word READY on the screen indicates the loading is completed. The Recorder will shut-off automatically.

To save a program, type CSAVE and press the RETURN key. The speaker will beep twice. After the speaker beeps, press the PLAY and RECORD buttons on the Recorder and then press the RETURN key. The program will then save. The word READY on the screen indicates the program has been saved. The Recorder will shut-off automatically.

DISASSEMBLY INSTRUCTIONS

CABINET REMOVAL

Remove six screws from cabinet bottom. Lift cabinet top up and disconnect keyboard cable. Cabinet top may now be removed.

MAIN BOARD REMOVAL

Remove four screws holding PC board to cabinet bottom. Lift PC board and metal shield from cabinet bottom. To remove shield, remove ten screws holding shield together and remove shield from main board.

MISCELLANEOUS ADJUSTMENTS

COLOR

Turn the Computer On and adjust the Color Control (R38) for a blue screen on the Monitor.

RF MODULATOR

CHANNEL ADJUST

Set TV on channel 2 or 3 with the AFC off. Set the Computer Channel Switch (S2) to the same channel and adjust the Channel Coil (L201) for the best picture.

SOUND ADJUST

Type in and run the following program in Basic.

```
10 SOUND 0, 100, 10, 15: GOTO 10
```

Adjust the Sound Coil (L202) for maximum sound with minimum noise.

PREVENTATIVE MAINTENANCE

ENVIRONMENT

Computers perform best in a clean, cool area that is below 80 degrees Fahrenheit and free of dust and smoke particles. Even though home Computers are not affected by cigarette smoke as much as commercial Computers are affected, it is better to maintain a smoke-free area around the Computer. Do not block cabinet vents of any of the Computer system; Computer, Monitor, Printer, or other power devices.

ELECTRICAL POWER

Variations in the line voltage can affect the Computer. Try to avoid these fluctuations by using an AC receptacle that is on a power line not used by appliances or other heavy current demand devices. A power-surge protector, power-line conditioner, or non-interruptable power supply may be needed to cure the problem. **Do not** switch power On and Off frequently.

KEYBOARD

Liquids spilled into the Keyboard can ruin it. Immediately after a spill occurs, disconnect the Computer power plug from AC power outlet. Then, if circuitry or contacts are contaminated, disassemble the Keyboard and carefully rinse the Keyboard printed circuit board with distilled water and let it dry. Use a cotton swab to clean between the keys. Use a non-abrasive contact cleaner and lint-free wipers on accessible connectors and contacts.

DISK DRIVES

Clean the read/write heads of the Disk Drives about once a month or after 100 hours usage. Use only an approved head cleaning kit.

Handle carefully to preserve proper disk head alignment. A sudden bump or jolt to the Disk Drives can knock the disk head out of alignment. If the disk drive must be transported, place an old disk in slot and close door during transport.

Store disks in their protective covers and never touch the disk surface. Observe the disk handling precautions usually found on the back of disk protective covers.

PRINTERS

Carefully vacuum the Printer regularly. Wipe surface areas clean using a light all-purpose cleaner. Do not oil the machine. The oil will collect abrasive grit and dust. The dust will act as a blanket. This can cause components to overheat and fail.

STATIC ELECTRICITY

Static electricity discharge can affect the Computer. In order to minimize the possibility, use anti-static mats, sprays, tools and materials, and maintain good humidity in the Computer environment.

MONITOR

Use an isolation transformer with any Monitor that does not come as part of the system since some Monitors use a HOT chassis (chassis connected to one side of the AC line). The face of the Monitor should never be left on for long periods of time at high brightness level except when pattern is being changed periodically. Use caution when cleaning anti-glare screens, to preserve the glare-reduction feature.

HOWARD W. SAMS & COMPANY

Remove staples and use cover for file folder.

COMPUTERFACTS™ put easy to use, informative technical data right at your fingertips. Each edition includes specific service information on the individual component, along with some overall troubleshooting hints.

The following information is just a sample of the many valuable time saving features contained in this exclusive Sams COMPUTERFACTS publication:

- Preliminary Service Checks section is an easy to use, step by step guide for the experienced technician or hobbyist, and even beginners.
- SAMS famous industry accepted standardized notation schematics containing CIRCUITRACE®, GRIDTRACE™, waveforms, voltages and stage identification.

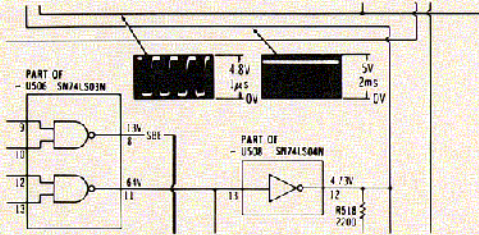

- Step by Step Troubleshooting guides the technician through the necessary procedures to quickly locate the problem.

TROUBLESHOOTING

MICROPROCESSOR CHIP (CPU) OPERATION

Verify the processor is functioning by checking the signals on the address lines (pins 10 thru 24 of IC U600) and the data lines (pins 41 thru 56) using a logic probe or a scope if a logic probe is used, refer to the "Logic Chart" for the correct readings. If a scope is used, the waveforms on the address lines (except pins 22 and 23 which have no signal in Power Up mode) should be similar to Figure 1. The waveforms on the data lines should be similar to Figure 2.

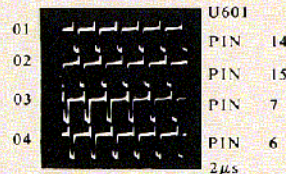

- Logic Chart containing logic probe readings to isolate defective circuitry and components.

LOGIC

PIN NO	IC U100	PIN NO	IC U100	PIN NO	IC U102	IC U103	IC U104	IC U105	IC U106	IC U107	IC U108	IC U109
1	P	21	P	1	L	L	L	L	L	L	L	L
2	P	22	P	2	P	P	P	P	P	P	P	P
3	P	23	P	3	H	H	H	H	H	H	H	H

- Quick Component Location using the SAMS exclusive GRIDTRACE, CIRCUITRACE, and component photographs.

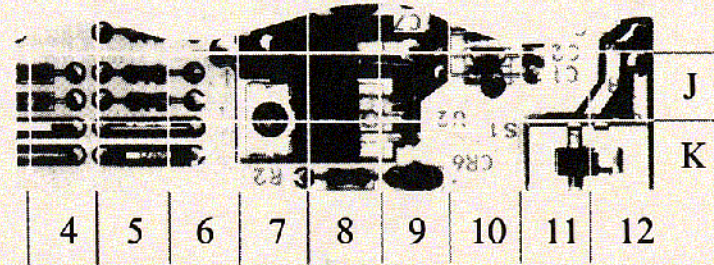

- Complete Components Parts List in an easy to use format with field replacements shown when possible. SAMS unique semiconductor, chip and IC cross-reference gives you many replacements to choose from and is available at your Electronic Distributor.

SEMICONDUCTORS (Select replacement for best results)

ITEM No.	TYPE No.	MFR. Part No.	ECG Part No.	NTE Part No.	REPLACEMENT DATA		NOTES
					RCA Part No.	ZENITH Part No.	
D102	1SS53	1149-2576	ECG519	NTE519	SK9091/177	103-131	
D103	2N60FM	1149-2527	ECG109	NTE109	SK3088	103-Z9001	
D201	1N4004GP	1201-4205	ECG116	NTE116	SK3312	212-76-02	
D501 thru D503	1SS53	1149-2576	ECG519	NTE519	SK9091/177	103-131	

CIRCUITRACE is a registered trademark of Howard W. Sams & Co. COMPUTERFACTS and GRIDTRACE are trademarks of Howard W. Sams & Co. Atari 800XL is a trademark of Atari, Inc. Atari is a registered trademark of Atari, Inc.

To order, or for more information see your Sams Distributor, or telephone 800-428-SAMS.



HOWARD W. SAMS & COMPANY

A Division of Macmillan, Inc.

4300 West 62nd Street

Indianapolis, Indiana 46268 USA