



**n e m e s i s**

**FALCON SYSTEM ACCELERATOR**

DESIGNED AND DEVELOPED BY PETER GREEN  
WITH BLACK SCORPION SOFTWARE LTD

JOINT COPYRIGHT © 1996 PETER GREEN &  
BLACK SCORPION SOFTWARE LTD

DISTRIBUTED BY TITAN DESIGNS LTD

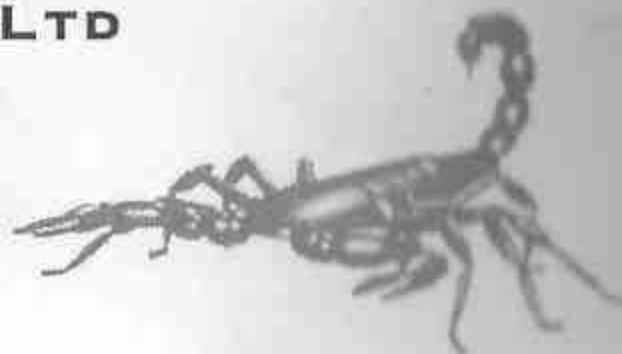

**n e m e s i s**

**FALCON SYSTEM ACCELERATOR**

**24/48 MHZ SYSTEM ACCELERATOR**

**FOR THE**

**ATARI FALCON030**

© 1996 PETER GREEN &  
BLACK SCORPION SOFTWARE

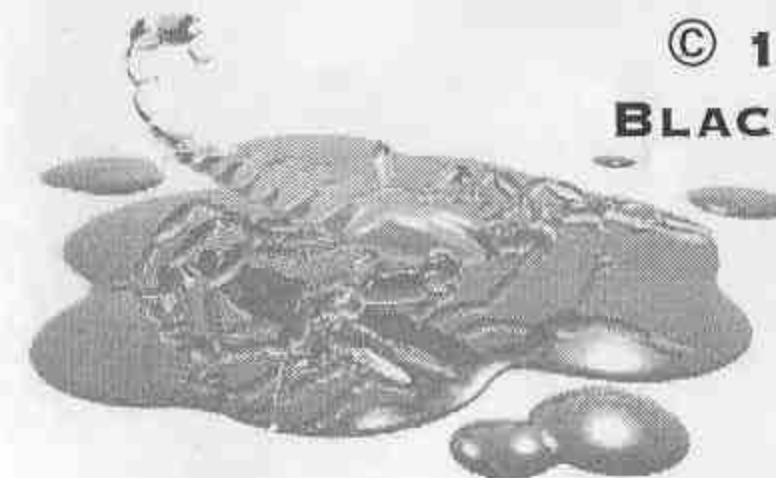

**CREDITS**

Falcon™, Falcon030™ are trademarks of Atari® Corporation.  
 GEM™ is trademark and copyright © Digital Research Inc.  
 APEX, APEX Alpha, APEX Media and Videlity are all copyright © Black Scorpion Software.  
 Exposé is copyright © TITAN Designs Ltd.  
 All other trademarks or copyrights of products mentioned within this manual are acknowledged as belonging to the persons or companies producing them.

**REPRODUCTION**

No part of this manual or the software may be reproduced in any form, on any media or by any means without the prior written consent of Black Scorpion Software Ltd.

**LIABILITY**

Black Scorpion Software Ltd and Peter Green make no warranty of any kind with regard to the use of the Nemesis accelerator board, including, but not limited to, the implied warranties of merchantability and fitness for a particular purpose.  
 Black Scorpion Software Ltd and Peter Green will not be held responsible for any incidental or consequential damages to the computer or any associated peripheral or software, in connection with the furnishings, performance, or use of the Nemesis Accelerator.

**Black Scorpion Software reserve the right to insert, remove or change features to the hardware or software specifications without prior notice.**

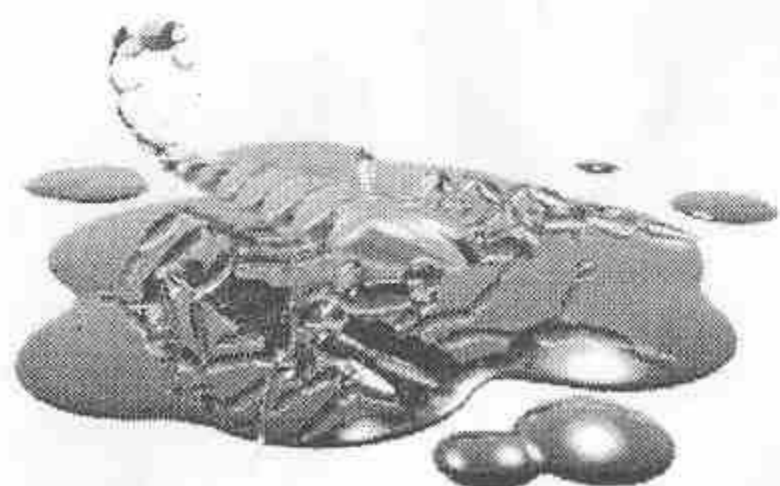

E & O.E. - Errors and Omissions Excepted

Nemesis is joint copyright © 1996  
 Peter Green & Black Scorpion Software Ltd

**CONTENTS**

1. INTRODUCTION ..... 5

2. WHY NEMESIS? ..... 5

    2.1 FAST BUS = HIGH-RES! ..... 5

    2.2 AFTERBURNER040 ..... 6

    2.3 VIDELITY ..... 6

3. TECHNICAL OVERVIEW ..... 6

    3.1 PACKAGE CONTENTS ..... 6

    3.2 FPU ACCELERATION ..... 7

    3.3 FALCON BENEFITS ..... 7

4. INSTALLATION OVERVIEW ..... 7

5. DISMANTLING THE ATARI FALCON ..... 8

    5.1. TOOLS REQUIRED ..... 8

    5.2. REMOVING THE TOP COVERS ..... 8

    5.3 REMOVING THE INTERNAL PERIPHERALS ..... 10

    5.4 PREPARATION ..... 10

6. INSTALLING THE BUFFER ..... 11

    6.1 WIRING THE BUFFER ..... 11

    6.2 MOUNTING ..... 12

    6.3 TESTING THE BUFFER ..... 12

        6.3.1 The Falcon boots up normally... 13

        6.3.2 Continuous black screen... 13

        6.3.3 White screen with no logo... 14

        6.3.4 Green/red patterned screen... 14

    6.4 ADDING THE DMA-BUFFER LINE ..... 15

    6.5 THE SECOND BUFFER TEST ..... 16

    6.6 THE BASIC DMA SIGNAL PATCH ..... 16

    6.7 THE FINAL BUFFER TEST ..... 17

7. PREPARING NEMESIS ..... 18

    7.1 OBSERVATIONS ..... 18

    7.2 LOCATION ..... 18



8. NEMESIS INSTALLATION .....	20
8.1 KEYBOARD (IKBD) & MIDI PATCHES .....	20
8.2 FIRST NEMESIS TEST - THE KEYBOARD PATCH .....	22
8.2.1 If the machine boots as normal...	22
8.2.2 If a persistent black screen is displayed...	22
8.2.3 If the machine boots up normally, but...	23
9. THE CPU/BUS ACCELERATOR.....	23
9.1 2ND NEMESIS TEST - THE 3 NEMESIS SPEEDS .....	24
9.2 ACCELERATING THE DSP .....	27
9.3 DOUBLE-CLOCKING THE FPU .....	27
10. VIDEL MODIFICATION.....	28
10.1 INSTALLATION .....	28
10.2 SWITCHING .....	29
10.3 VIDEL TEST .....	29
10.4 RGB SYNC FIX .....	30
11. REASSEMBLY .....	30
11.1 REFITTING FAN .....	30
11.2 REBUILDING NOTES .....	31
12. SOFTWARE .....	31
12.1 NEMBENCH .....	31
12.2 DSPBENCH .....	32
12.3 NEMESIS SPEED SETTINGS .....	32
12.3.1 NEM_HI.TOS & NEM_LO.TOS .....	32
12.3.2 NEM_OFF.TOS .....	32
12.4 HIGH-RES. TRUE COLOUR (HRTC) .....	32
12.5 SPEED DETECT .....	33
12.6 VIDELITY .....	33

APPENDICES

1 - STABILITY ISSUES .....	34
2 - FUTURE COMMITMENT FROM BLACK SCORPION SOFTWARE .....	37
3 - INTO THE FUTURE .....	38
ADDENDUM - PRINTING & SPEED CIRCUIT.....	39

## 1. INTRODUCTION

The Nemesis Accelerator was originally developed primarily to support the latest APEX Alpha software, which benefits greatly from the extra processing power on offer and, more importantly, can achieve high resolution, true-colour on VGA monitors. Although hardware support for APEX Alpha was our primary consideration, Nemesis is equally superb for virtually any software that is compatible with the Atari Falcon.

Nemesis increases the speed of the Bus, 68030 processor (CPU), 68882 maths co-processor (FPU) and the 56001 Digital Signal Processor (DSP), and these advantages are particularly noticeable when using programs such as APEX Media and APEX Intro which are machine coded for the CPU and DSP.

Other benefits can be seen for software coded to use the FPU, such as ray-tracing and rendering programs. In addition the image capture rate of Titan Designs' Exposé video digitizer increases up to 50% faster.

Overall the advantages to Atari software when using Nemesis are massive, as screen re-draws and the processing of data are much more rapid and, coupled with high resolution, true-colour displays, these benefits give your Falcon an added dimension.

## 2. WHY NEMESIS?

Nemesis is important for a variety of reasons, but mainly as support for the latest Black Scorpion development, APEX Alpha, which relies on a far higher bus speed - 24MHz (MegaHertz) - to achieve up to 720x528, 16-bit true-colour on standard VGA monitors. Higher resolutions than this should be possible on better grade multisync monitors.

### 2.1 FAST BUS = HIGH-RES!

While other accelerators may only drive the bus to 20MHz, this will not be sufficient to realise the highest resolutions and, in some cases, the low horizontal frequency rate still might not drive some VGA monitors properly. Although Nemesis may 'only' provide a 24MHz clock speed to the CPU, the whole system performance is raised similarly, regardless of raw CPU speed. In addition, the APEX series of programs rely heavily on DSP acceleration which Nemesis maximizes to the full.



## 2.2 AFTERBURNER040

Users of the Afterburner040 board who also have Nemesis fitted, will see an increase in performance from 16.5/33/66MHz (Bus/CPU/Pipe) to 20/40/80MHz. This reveals an overall performance which exceeds **9 times** that of a standard Falcon!

## 2.3 VIDELITY/EXPOSÉ

To support the higher resolution capability of Nemesis, Black Scorpion have also developed an inexpensive screen enhancement program called Videlity. This enables resolutions to be reconfigured safely with fast, smooth and glitch-free switching between various video modes. Videlity also supports external video hardware.

Future Videlity support for Exposé will include a true-colour, on-screen, PiP (Picture-in-Picture) display, **IRRESPECTIVE** of the actual video mode in use! This is displayed as a standard Desktop (mono, 16-, or 256-colour) at the top of the screen, with a true-colour band, containing the PiP data, across the top of the screen.

## 3. TECHNICAL OVERVIEW

Nemesis uses two crystal oscillator modules which can be switched between 48MHz (primary), 40MHz (secondary) and normal operation. Whichever value is in use will accelerate the DSP and FPU accordingly. To achieve the lower frequencies for the CPU and Bus, the clock speed is then divided by two, i.e. to 20 or 24MHz respectively.

In addition the default (48MHz) clock value can be changed to a different value simply by plugging in a new oscillator. A reliable performance cannot be guaranteed for every machine when exceeding 48MHz but may benefit some users.

### 3.1 PACKAGE CONTENTS

Enclosed in the package you will find the following;

- The Nemesis accelerator - the larger board
- The Buffer modification - the smaller board
- 82pF (pica-farad) and 150pF capacitors
- 1.44MB floppy disk containing driver and test software. Please check any README file that may exist for last minute changes to either the hardware or software.

For safety, and **BEFORE** you do **ANYTHING** to the Falcon, transfer all files to the hard disk.

## 3.2 FPU ACCELERATION

With regard to FPU acceleration it is possible that some FPUs might not function correctly at 48MHz. This could happen if the FPU fitted is only rated at 16MHz - denoted on the chip as MC68882-16 (or similar). Fortunately, the FPU can be left at the system speed of 24MHz (representing a 50% improvement) if problems are found.

Our tests indicate that an FPU rated at 16MHz **may** achieve 48MHz, while a 25MHz **could** work at 48MHz. An FPU marked 33MHz should be fine.

## 3.3 FALCON BENEFITS

Apart from accelerating the Falcon, various modifications to the Falcon motherboard are necessary for successful operation of Nemesis, which improves system reliability whether or not Nemesis is fitted. Greater system reliability can therefore be seen when just the Buffer is fitted to machines having an Afterburner040 fitted.

## 4. INSTALLATION OVERVIEW

You will need to dismantle the Atari Falcon and possess a reasonable degree of soldering skills in order to fit Nemesis. It is worth noting at this stage, that the **ICD hard disk driver software is unsuitable for use with Nemesis** and if you are currently using this software, it will be necessary to revert back to the standard Atari AHDI software or consider using HD Driver from v3.5 or higher. Early versions of HD Driver may work, but have not been tested.

The following instructions are very explicit but in the event of any queries we are only a phone call away. If, after reading through this manual, you would prefer not to carry out the modifications please contact Titan Designs (see foot of any page), or;

The Upgrade Shop (TUS), Tel: 01625 503448

Unit F6, Venture House, Cross St., Macclesfield, Cheshire SK11 7PG

Please arrange before dispatching your Falcon to ensure the upgraded machine is returned promptly. It is also very important to ensure that the Falcon is packed carefully, as responsibility for any damage that may occur during transit is the responsibility of the owner.



## 5. DISMANTLING THE ATARI FALCON

As with any piece of electronic equipment, great care must be taken when handling the Falcon motherboard and the Nemesis accelerator. The instructions assume that a standard Falcon is being dismantled and is in its normal operating position.

 **Handle the Falcon motherboard WITH CARE!**  
Static electricity can irretrievably damage the components

When dismantling the Atari Falcon it is important to remember the location of each screw, as they can differ in length and thread, e.g. some are M3 thread and others are self-tapping.

### 5.1 TOOLS REQUIRED

The only tools needed to dismantle the Atari Falcon are a Pozidriv screwdriver, a small pair of pliers and some nimble fingers.

### 5.2 REMOVING THE TOP COVERS

Firstly, remove all external connectors and peripherals from the Falcon, including the mouse and any disk that may be in the floppy disk drive.

 **MOST IMPORTANT - Remove the power cable!**  
We cannot be held responsible for any damage or injury sustained

- Turn the computer over and remove the seven screws located in the square recesses, and the three long screws in the round recesses. While holding the two halves of the case together, turn the computer back to its normal operating position.
- Lift the top plastic case to reveal the keyboard and internal metal shielding. Lift the keyboard from the back and unplug the connector from the motherboard.
- Around the periphery of the top metal shielding there are nine screws, plus three which can be located to the rear above the power switch and power inlet socket. In addition there is a single metal tab.
- After removing the twelve screws and straightening the metal tab, carefully lift the top metal shielding - but before removing it entirely, unplug the 2-pin speaker connection which is situated between the floppy disk and hard disk drives.

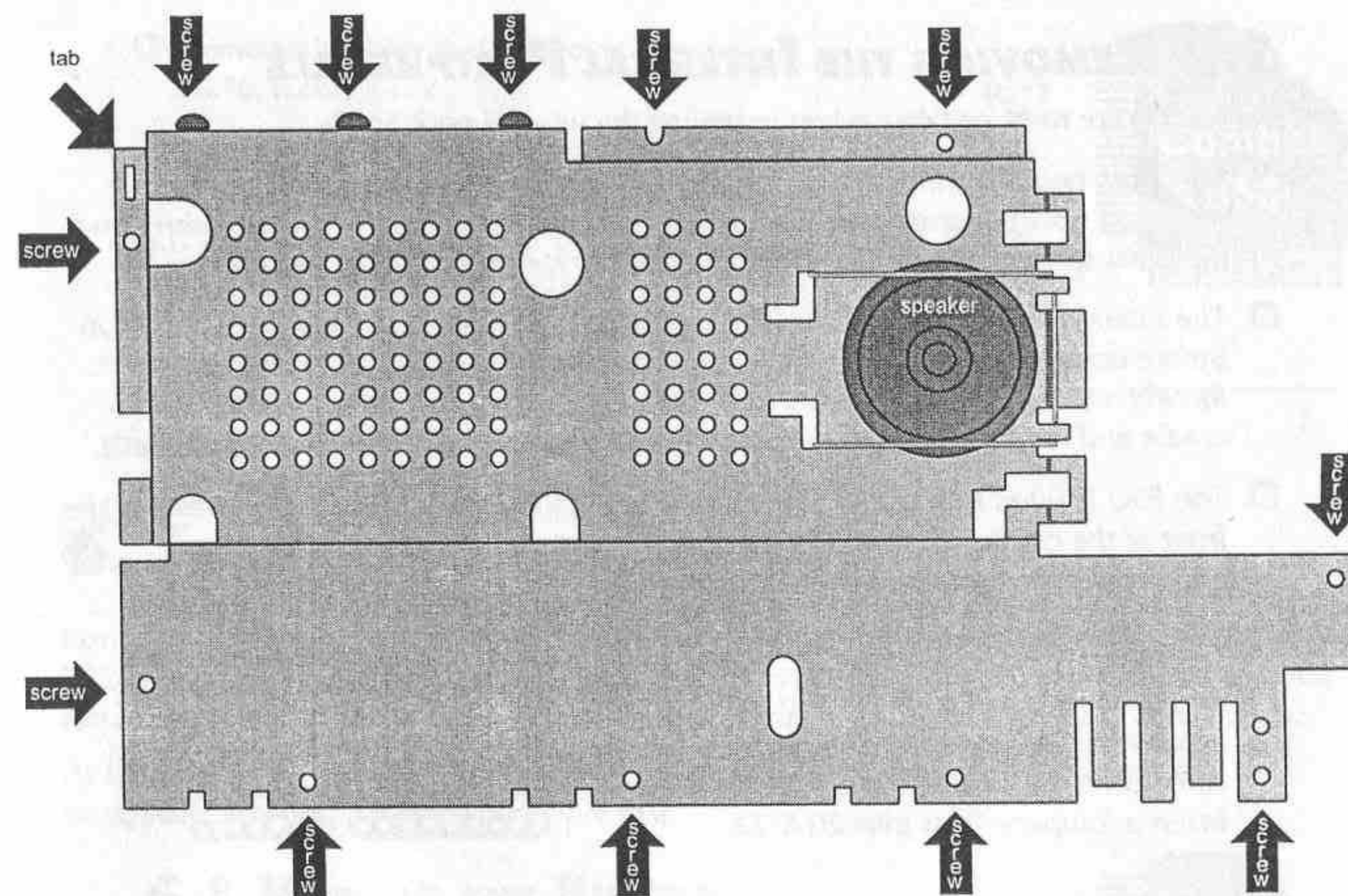

(e) Removing the top metal shielding will now reveal the power supply (PSU), internal hard drive (if fitted), floppy drive and memory board.

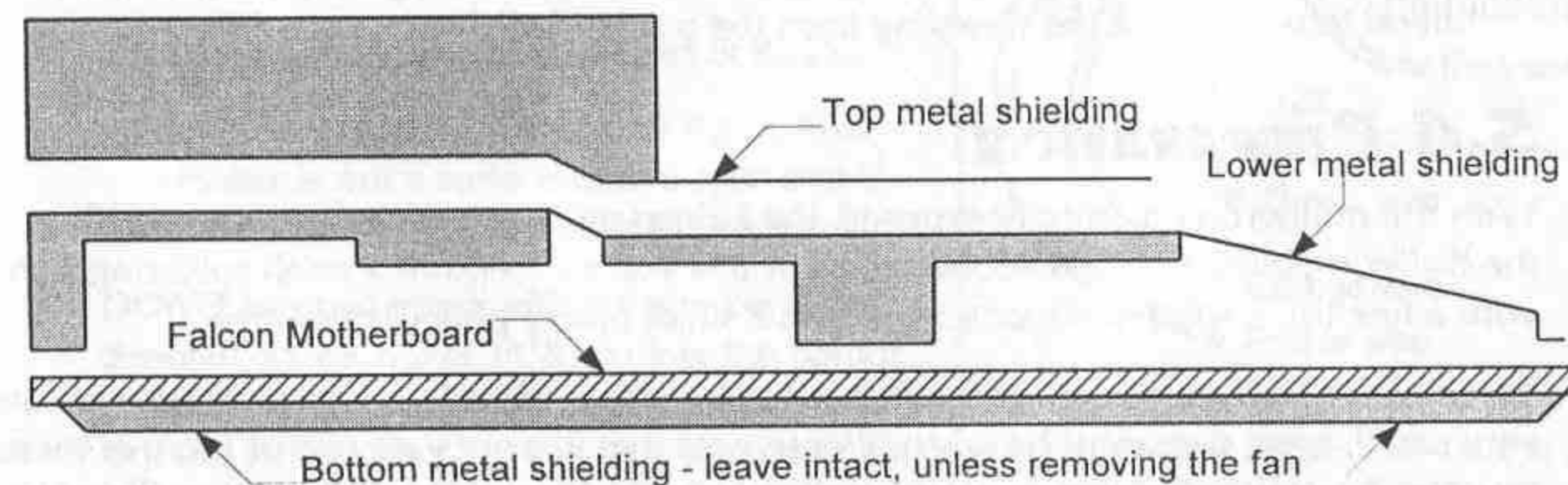



### 5.3 REMOVING THE INTERNAL PERIPHERALS

Particular care must be taken when removing the internal peripherals.

- The 4-pin power connector and 34-pin data connector to the rear of the floppy drive can now be removed. After unplugging the cables, place the floppy drive and the brass spacer to one side - **DON'T** leave the spacer inside the Falcon!
- The internal IDE hard disk drive (if fitted) is located to the rear/centre of the Falcon. Before unplugging the 44-pin data connector examine the connection to the drive, for when you need to reassemble. Remove the four screws from the base of the cradle and remove the hard drive, complete with cradle, putting it in a safe place.
- The PSU is fitted to a cradle and secured to the motherboard with two screws at the front of the cradle. Remove the two screws and unplug the 8-pin power connector.

After removing any expansion board ...

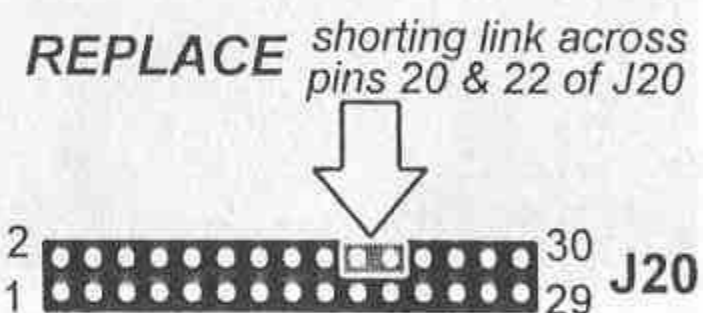

- Remove any device that is fitted to the Expansion Connector, such as Exposé, Afterburner040, Falcon Speed, etc., and insert a jumper across pins 20 & 22.

The lower metal shielding covers certain areas of the Falcon motherboard which need to be accessed when installing Nemesis - this does not refer to the **bottom** metal shielding which can be left intact.

- Remove all remaining screws from the lower metal shielding and straighten the metal tabs. Now lift the shielding from the motherboard.

### 5.4 PREPARATION

With the motherboard entirely exposed, the Falcon needs preparing prior to installing the Buffer modification and accelerator. For this you will require a small soldering iron with a fine tip, a sharp knife or scalpel and a small pair of pliers or tweezers.

Three of the 'surface-mount' resistors need to be removed and, as these components are very small, great care must be taken. Please note that it is possible one or more of these resistors have already been removed, particularly if a PowerUp accelerator or BlowUp FX card is/was fitted at any time.

**! VERY IMPORTANT !**

- Remove the three surface-mount resistors R216, R221, R222.
- Check that there are no cut tracks in this area. Repair them if necessary.

This is best achieved by using a small soldering iron and a pair of tweezers or small pliers. While heating up one edge of the solder pad, use the tweezers to gently lift the resistor. **DON'T** force them off the motherboard as this could lift the solder pad!

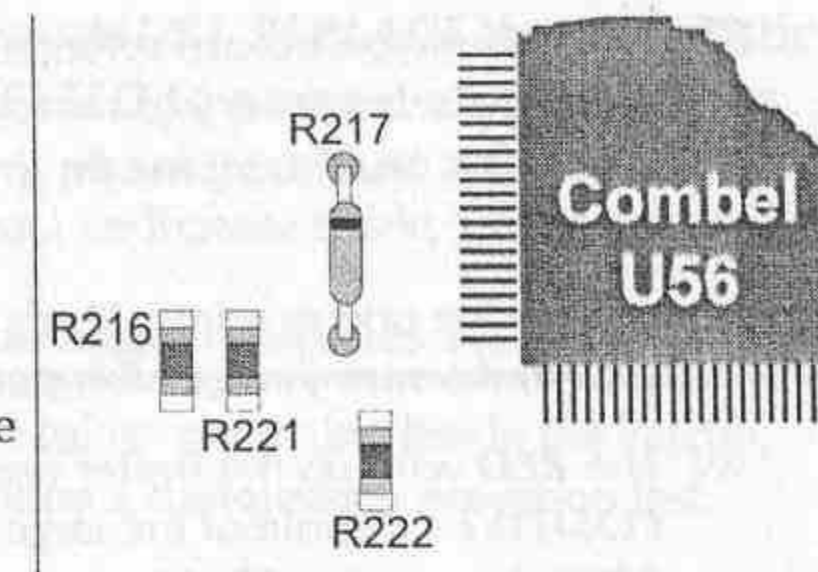

## 6. INSTALLING THE BUFFER

Positioning of the Buffer (the smaller white box) is crucial because all the wires leading to R216, R217, R221 & R222 **MUST** be kept as short as possible, otherwise the Falcon may not run reliably. Place the Buffer as denoted in the diagram and shorten the wires accordingly.

As the wire leading to R222 needs to be underneath where the Buffer will eventually be positioned, it is advisable to fit this wire first.

### 6.1 WIRING THE BUFFER

Solder the following wires;

- (a) **GREEN** wire to the **BOTTOM** pad of R222.
- (b) **PURPLE** wire to the **TOP** pad of R216.
- (c) **ORANGE** wire to the **TOP** pad of R221.
- (d) **BLUE** wire to the **TOP** pad of R217. This resistor is not a surface mount type and is quite close to the those already removed.

**DON'T** be concerned with the numbers denoted on the Buffer PCB - follow the colour codes given above. Due to the way the wires exit the Buffer card, there is only one particular combination that allows the card to sit 'naturally', without crossed wires or excessive pressure on the solder pads.

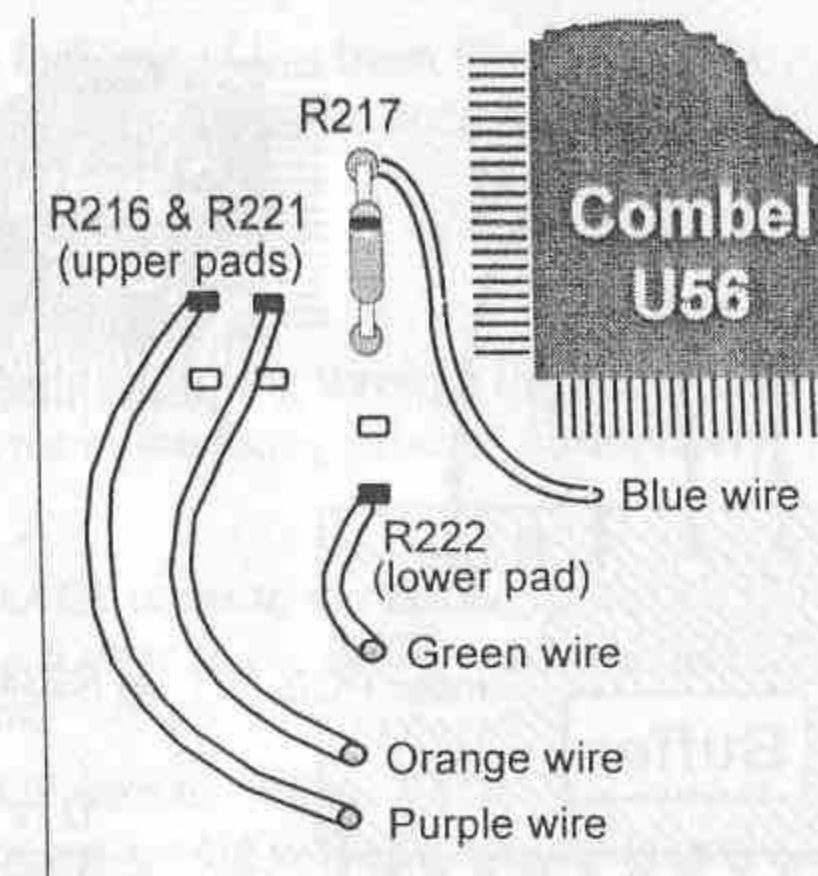



- ❑ Ensure these points are soldered with care, as it may be necessary to remove some wires later on, depending on the success of the testing phase (described later).

Now solder the power wires. *Study the picture (right) to make sure you get this part right!!!*

- (e) The **RED** wire on the Buffer card to the **POSITIVE (+)** pole of the large electrolytic 4700uF capacitor (C147), situated close to the PSU, and partly hidden by the internal hard disk. The positive pole is marked on the PCB with a small '+' plus sign.

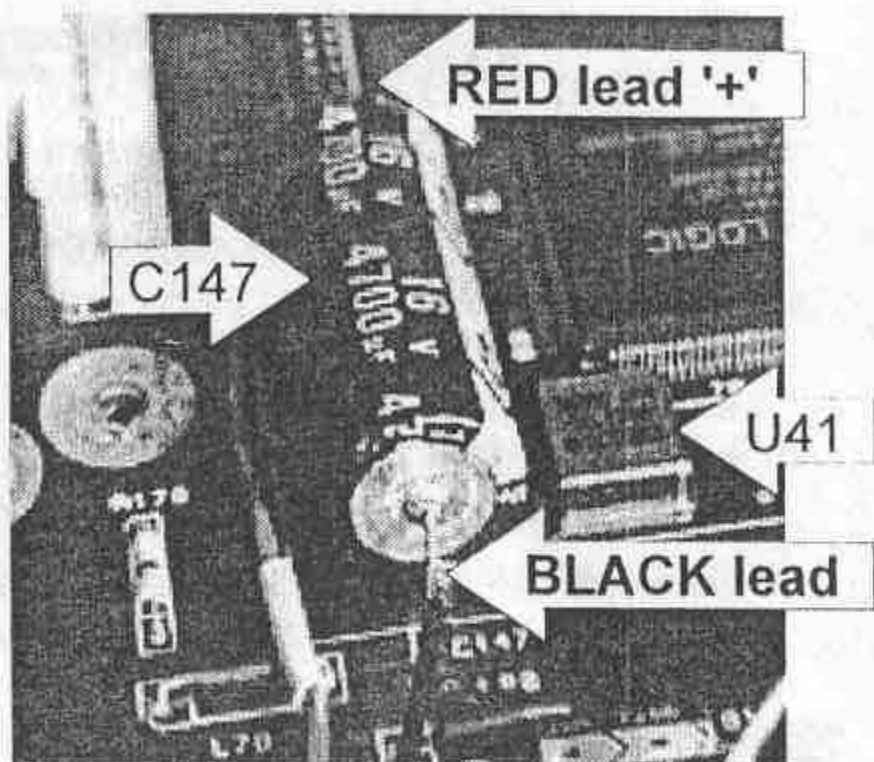

- (f) The **BLACK** wire from the Buffer card goes to the **NEGATIVE (-)** pole of C147.

The remaining **WHITE** wire should be left unconnected for the time being. Make sure the bare end of this wire is insulated from the Falcon PCB until it is connected later on.

Now that all the wires (except white) are properly connected, the Buffer card must be fixed in place, so as not to be disturbed when the Falcon is moved.

## 6.2 MOUNTING

The Buffer can only be fitted in one position due to the need for extremely short wires. If anything prevents the Buffer from being mounted in the correct position, then remove this device elsewhere.

Position the board as detailed in the diagram (left), and fix it to the Falcon using the double-sided tape.

## 6.3 TESTING THE BUFFER

Before fitting the Nemesis accelerator, it is strongly advised that the first checks are carried out, to prevent confusion should two similar problems arise at a later stage.

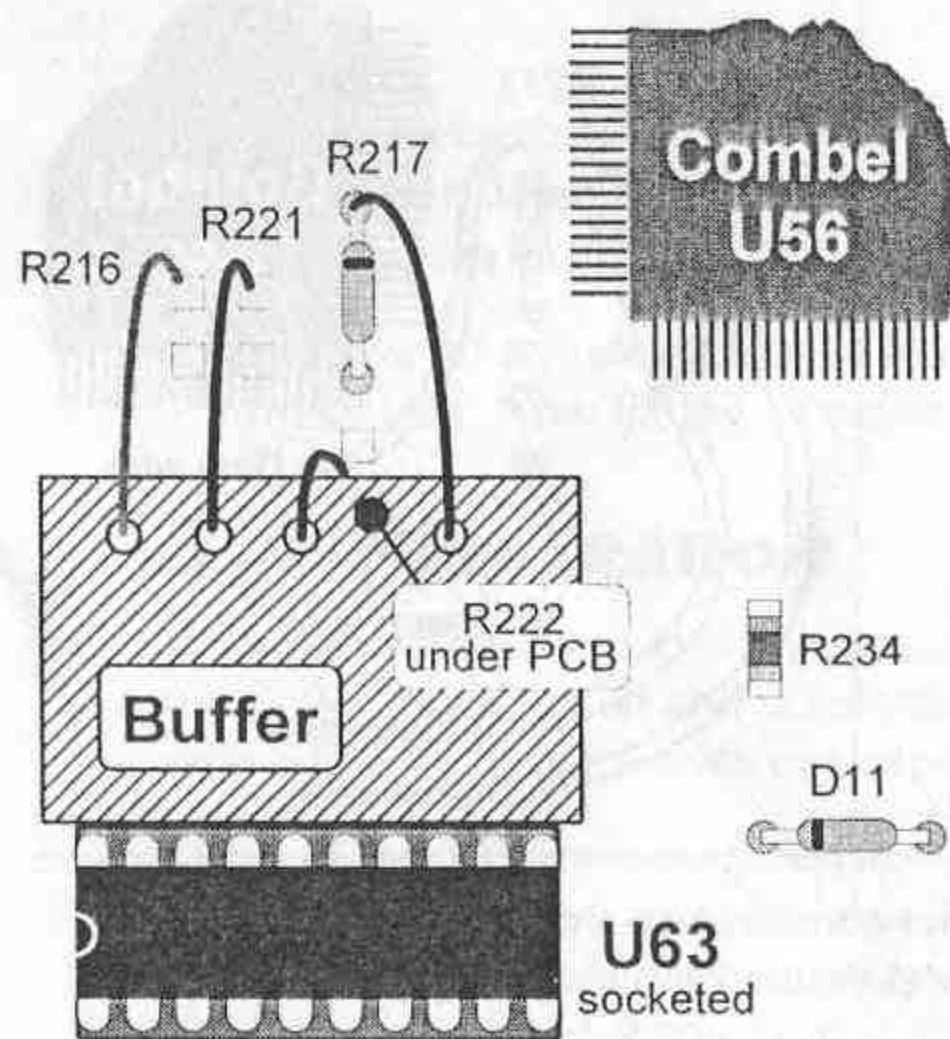

## !! VERY IMPORTANT !!

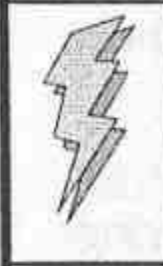

As this means powering up the Falcon, you **MUST REPLACE** the top plastic cover **EACH TIME NEMESIS IS BEING TESTED** to prevent electric shocks from the power supply. After each testing phase you must **ALWAYS** disconnect the power cable!

We cannot be held responsible for any damage or injuries sustained.

- (a) Make sure there are no bare wires or scraps of solder remaining inside the Falcon. The following should now be replaced to perform a rudimentary power-on test.

This should **DEFINITELY** include replacing;

- ❑ IDE hard disk drive, the power supply (PSU), the keyboard and the top plastic cover (the latter is **MOST** important).

It is **NOT** necessary to replace the following for this simple test:

- ❑ Floppy disk drive, top metal shielding (but replace the top plastic cover!)

- (b) Once you have replaced these components, and making sure you have left nothing inside the Falcon that should **NOT** be there, turn the Falcon on and watch the display. One of four things is likely to occur;

### 6.3.1 The Falcon boots up normally - Good news!

If the machine boots up normally, then the Buffer card has been fitted correctly. After checking the keyboard works, and the hard disk can be accessed, continue installation with SECTION 4 - ADDING THE DMA-BUFFER LINE.

### 6.3.2 Continuous black screen.

Dull news. Just turn the machine off. No signal is passing through the buffer card to the Falcon - probably due to either an error in the fitting process (more likely) or a faulty Buffer card (less likely).

- ❑ Check you have soldered the **RED & BLACK** wires to the correct poles on the 4700uF capacitor. These wires supply +5 volts to the buffer card, and **MUST** be correct for the buffer to operate at all.
- ❑ Make sure you have connected the **BLUE** wire to resistor **R217**. This wire is the signal input to the Buffer card. Incorrect wiring will again result in zero response from the Falcon.
- ❑ Check the three other Buffer wires to make sure they are connected **ONLY** to the locations indicated. Check for any scraps of solder which might be causing a short-circuit.



- If your machine previously contained another make of accelerator card, make sure any tracks which may have been 'cut' during the fitting of the older accelerator are re-made with solder or a thin wire.
- If the problem persists, and you can see no logical reason for this, try moving the **BLUE** wire to the **TOP** of **R217** instead. This isn't normally recommended, but it is possible the Falcon is supplying a weak clock signal.
- If none of the above makes a difference, reverse the Buffer installation and get the machine back to its original state. The installation can now be retired, or contact Titan/BSS for help.

### 6.3.3 White screen with no logo

**Bad news - Turn your Falcon off NOW!**

With a white screen and no Atari logo, there is definitely a clock signal reaching the Falcon from the Buffer card - but something else is preventing the Falcon from booting normally.

- Check there is a small jumper on the expansion port. It isn't necessary to remove this normally, but it could happen if a video card, accelerator, digitizer or emulator hardware was fitted which was removed to fit the Buffer.
- Check for solder scraps and fragments - especially between the pins of the large surface mount devices (CPU & Combel chips). Solder dust caught between the legs of these things frequently leads to such problems. Use a small, firmly bristled paintbrush to get rid of any solder dust.
- Ensure no chips have become dislodged during the fitting of the Buffer card. The GAL chips are socketed, and can be loosened accidentally.
- Ensure no solder blobs have short-circuited anything important. Use a circuit-tester if possible.
- If the problem persists, reverse everything and test the machine in a clean state. Contact Titan/BSS if things do not improve.

### 6.3.4 Green/red patterned screen

**Very bad news. Turn off IMMEDIATELY!**

With a green/red moire or chaotic pattern effect, then some solder debris has almost certainly got lodged between the pins of one of the large surface-mount devices near the Buffer. This debris normally tends to be produced by desoldering tools and can get onto the motherboard.

Look out for this problem during the later installation stages, as it can be a serious risk and damage may be inflicted by leaving the Falcon on for too long in this state. Use a small, firm brush to remove any offending solder debris.

- If the problem persists, reverse everything and test the machine in a clean state. Contact Titan/BSS if things do not improve.

## 6.4 ADDING THE DMA-BUFFER LINE

With the Buffer card working, the next step involves connecting the single remaining white wire from the Buffer to the DMA chip. This requires relatively skillful use of a scalpel or other sharp blade, and should be done with great care. The modification is easy to reverse so long as it is done properly, and with some patience.

- (a) Find the device marked U36 which is located underneath the Floppy disk drive. This is the DMA chip which is responsible for access to SCSI drives and handles most forms of audio playback. It has a large number of pins and is relatively isolated from the main part of the Falcon.
- (b) Locate pin 110 of this chip, (**RIGHT NEXT** to the top-left corner pin) and look for the horizontal track leaving this pin (leftwards), which 'detours' around L66 (inductor).
- (c) Follow this track to where it detours (avoiding the inductor L66). This is about 1 cm. left of U36. Make a **SMALL** cut in this track where it turns the corner. This is a useful area to make the cut, in case the track needs rejoining at any time. Do not cut the track too close to U36 itself.
- (d) Scrape some of the solder-resist coating away from the **RIGHT** of the cut, i.e. the side **NEAREST** U36.
- (e) Plan a suitable route for the **WHITE** Buffer wire to reach the newly exposed PCB track near U36. Taking the wire around the top of the Floppy disk connector is a good start. **MAKE SURE THE WHITE WIRE IS KEPT AS SHORT AS POSSIBLE.** If too much wire is used, potential difficulties may be added to the DMA later on, when Nemesis is fitted and working. Avoid running the wire under the memory board.

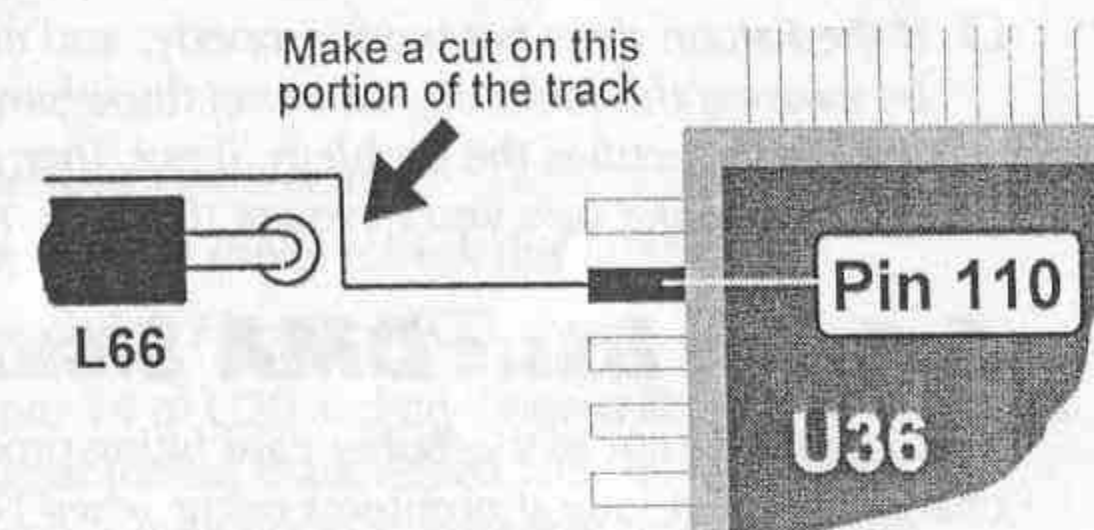



- (f) Measure, cut and solder the **WHITE** wire from the Buffer card to the newly exposed section of track leading to U36. Make sure this is done with **GREAT CARE**. Do not let the wire exert **ANY** pressure on the exposed track, or it may tear from the PCB. Using a tiny amount of superglue or some insulating tape, fix the wire firmly in place close to the connection point, in order to remove strain from the solder joint.

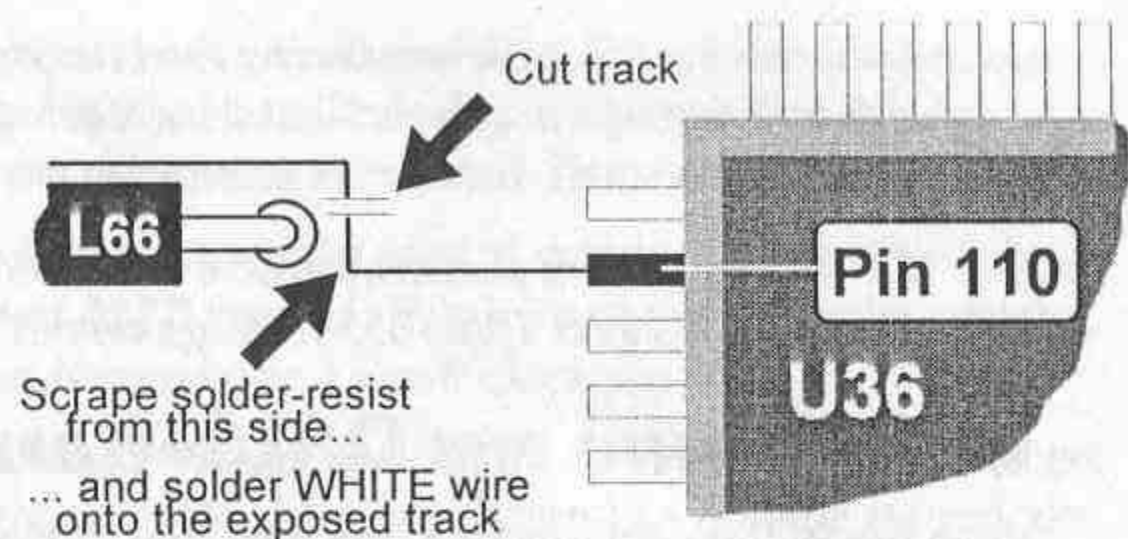

## 6.5 THE SECOND BUFFER TEST

Repeat all of SECTION 3 - TESTING THE BUFFER. Make sure the Falcon is operating correctly with the white wire connected to the DMA chip U36.

- If the Falcon boots up properly once again, then proceed to 6.6 - THE BASIC DMA SIGNAL PATCH.
- If the Falcon does not work properly, and nothing indicated in Section 3 seems to be causing the fault, try removing the white wire and re-joining the cut track and see if this rectifies the problem. If not, then check to see if more than track has been cut, and make sure you have cut the right track to begin with!

## 6.6 THE BASIC DMA SIGNAL PATCH

This is the last part of the Buffer card fitting process. It may be necessary to remove or change this part later if problems occur when Nemesis is fitted and working, so make sure it is done carefully so changes can be made later.

Now locate the 150pF capacitor.

- If the type of capacitor used has short legs, it might be necessary to solder a short wire onto one end of the capacitor, to increase it's length to around 25mm.
- (a) If the capacitor has long legs, trim one of them to about 4-5mm and solder this to pin 14 of U20.

- (b) Solder the other leg of the capacitor (it may need bending) to the **SAME** solder joint made earlier when the **WHITE** Buffer wire was soldered to pin 110 of the DMA chip. Essentially this is now a 3-way solder joint.
- Take care when bending the pin, as a crack in the ceramic coating can affect the capacitance!

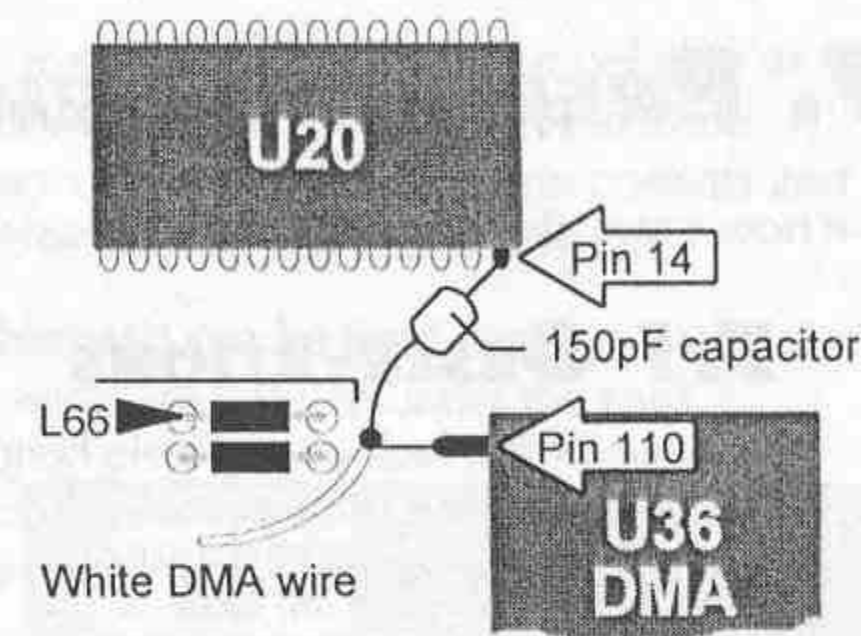

## 6.7 THE FINAL BUFFER TEST

Repeat SECTION 3 - TESTING THE BUFFER. Ensure the Falcon is operating correctly with the capacitor connected between pin 14 of U20 and pin 110 of U36. If the Falcon boots up properly yet again, then proceed to the next Section - INSTALLING NEMESIS - the first part of the Nemesis accelerator installation.

If the Falcon misbehaves in any way;

- Continuous black or white screen.
- Coughing, spluttering, repetitive warm resets.
- Problems accessing Floppy or SCSI drives (check this later).
- Rubbish flashing on screen during Floppy or SCSI access.

... then remove the capacitor from pin 14 of U20 and continue with INSTALLING NEMESIS anyway, as the problem of DMA signal tuning is addressed later on (Appendix 1 - Stability Issues). Make sure the Falcon is working in every other respect before continuing with the next section, or confusion will arise!



## 7. PREPARING NEMESIS

We now cover the fitting of the Nemesis card and problems involved with location.

### 7.1 OBSERVATIONS

Because of the lack of available height inside a *standard* Falcon, Nemesis can *only* be positioned in one of two places. Recased Falcons should not present a problem but the following observations should still be made;

- All the wires leading to components on the motherboard **MUST** be kept short.
- With the number of wires coming from the Nemesis case, it is probably best to identify each wire, its location, and the shortest possible route.

### 7.2 LOCATION

- (a) The Nemesis card should be located (ideally) at the front of the motherboard. For recased Falcons the best location is just in front of the motherboard (see right) or in front of the original system clock (see below).

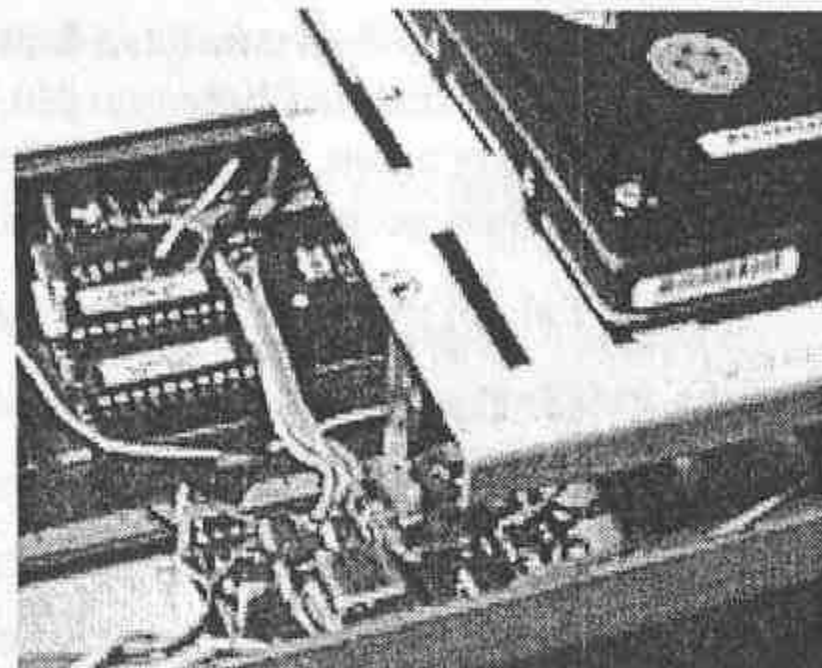

Right: Nemesis fitted to a C-Lab MK.X case

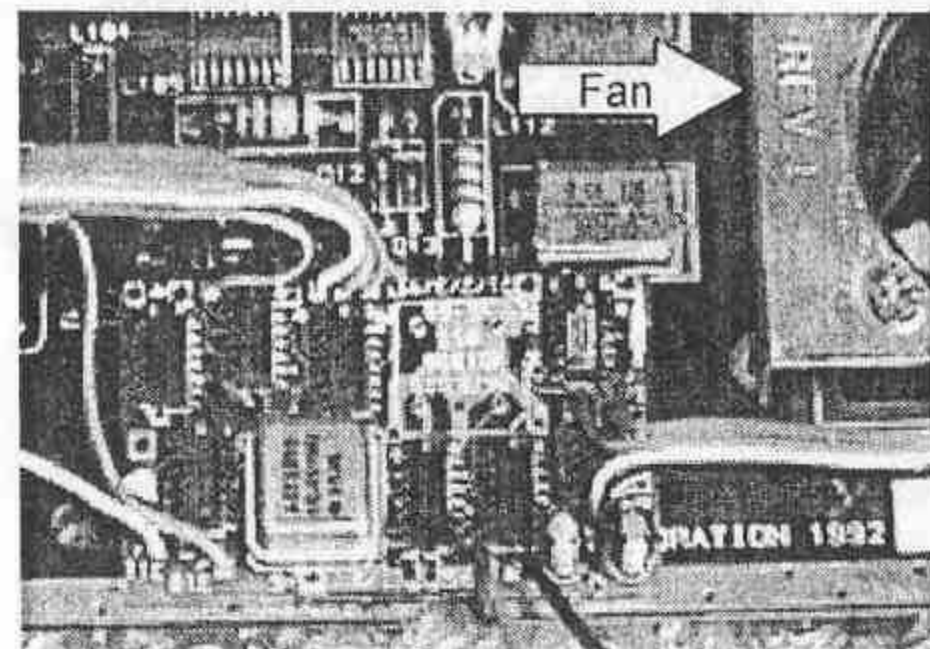

Nemesis fitted to a standard Falcon case

- (b) With a standard Falcon case, Nemesis can be mounted as in the photo (left), although this does mean cutting the metal shielding. However, the preferred method is to remove the fan, and its metal cover, and place Nemesis over the vacant hole. This prevents any possible overheating problems that can occur (see **Appendix 1.1.1**). The fan is resited in the top metal shielding (see **pages 30/31**)

- Mount the Nemesis board so that the wires have the shortest possible run.

- It is most important that Nemesis is **NOT** located near the CPU, Combel chip or memory card, since the ambient temperature & RF interference levels at these locations can have an adverse effect. Nemesis uses very sensitive components and should be kept clear of these locations, and as cool as practically possible.
- (c) Once a suitable location has been found, Nemesis can be fixed firmly in place using the double-sided tape supplied. Ensure no wires are trapped under the card.

- (d) If Nemesis is located at the front of the motherboard (recased Falcons only), two additional short ground wires (single core - use a paper clip for excellent rigidity!) should be connected from the Falcon outer ground rail to the Nemesis board, using two of the solder pads marked 'e'.

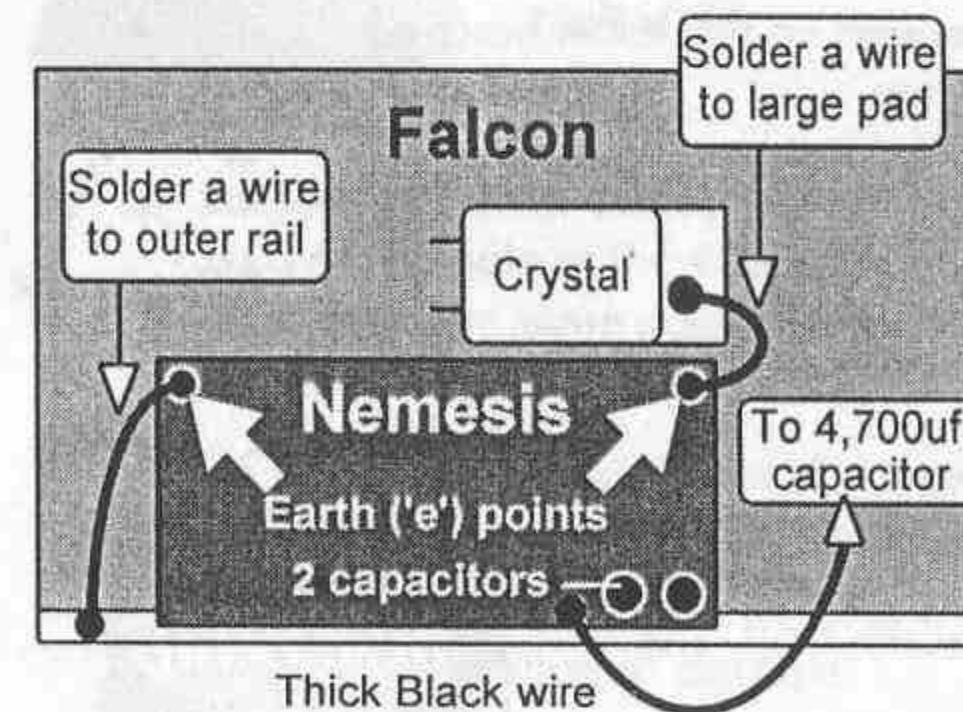
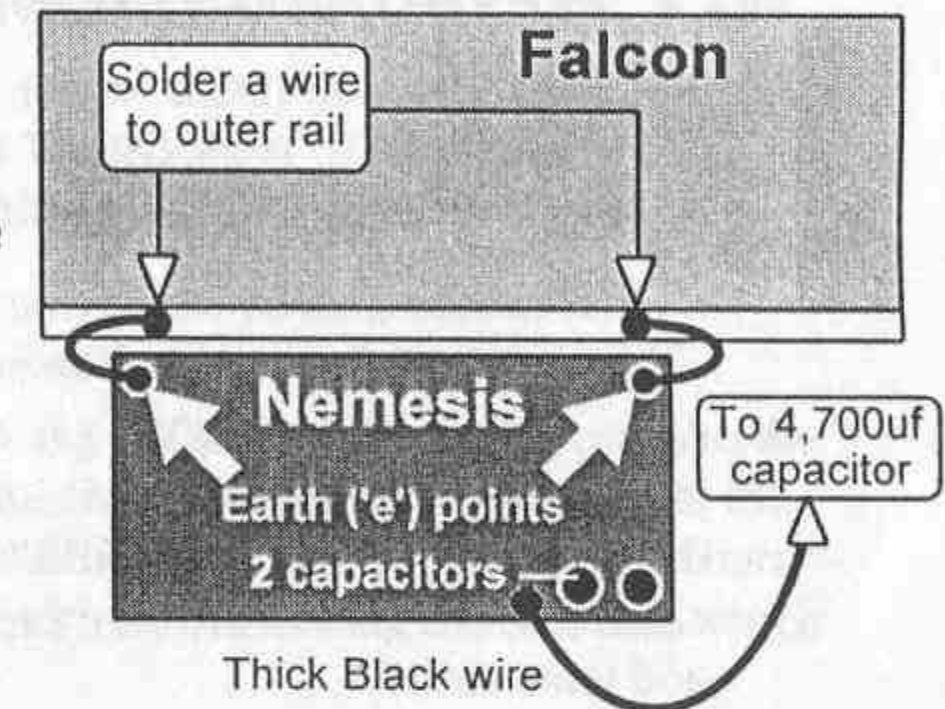

- (e) If Nemesis is fitted to a standard Falcon, a suitable arrangement for grounding the card properly is imperative. The best position is to link an additional wire to the outer ground rail surrounding the Falcon, and another to the large solder pad immediately under the crystal (left).

- Nemesis is very sensitive to interference and it is strongly advised that these ground attachments are not ignored - it may lead to low stability of the machine if not implemented sufficiently well.

- NOTE:** The preferred method for mounting Nemesis in a standard case (as detailed on the previous page) does mean resiting the fan into the top metal shielding, and mounting Nemesis where the fan used to be situated - overheating problems could occur otherwise. Obviously this is not really practical when a 38-40mm hole needs to be drilled, but this service can be arranged with Titan Designs if necessary.



## 8. NEMESIS INSTALLATION

The next stage of the Nemesis fitting sequence is installing the modification which allows some of the less tolerant peripherals to operate with a higher system clock in use. These modifications are implemented at this stage as they can be easily tested independently.

### 8.1 KEYBOARD (IKBD) & MIDI PATCHES

- (a) Find the MIDI chip (U24), which is located very near the MIDI ports at the top-left of the Falcon PCB. With **GREAT CARE** use a pair of small wire cutters to cut pins 3 & 4 as close to the PCB as possible. A wire is soldered to the severed pins later on.

It should also be noted that this part may need to be reversed later if the power-on test in the next section is not successful.

- (b) Again, with care, bend pins 3 & 4 of the MIDI chip away from the PCB, and either solder them together or use a very short wire loop. Be careful not to stress the pins - the metal is soft and tears easily.

- (c) Solder one of the **PURPLE** wires to the newly joined pins 3 & 4 on the MIDI chip. Shorten the wire to just span the distance required.

By keeping the wiring tidy you can reduce the possibility of interference which can affect stability when Nemesis is turned on.

- (d) Locate pin 3 of the IKBD chip (U52), located near where the keyboard plugs in. As described in part (a) above, use a pair of snips to disconnect this pin from the PCB, and bend it slightly upwards.

Some Falcons benefit from having pins 3 & 4 cut and lifted, but it's advisable to try just pin 3 first.

- (e) Solder the other **PURPLE** wire to pin 3 of U52, making the wire just long enough to span the required distance, but **NOT** running it under the memory board.

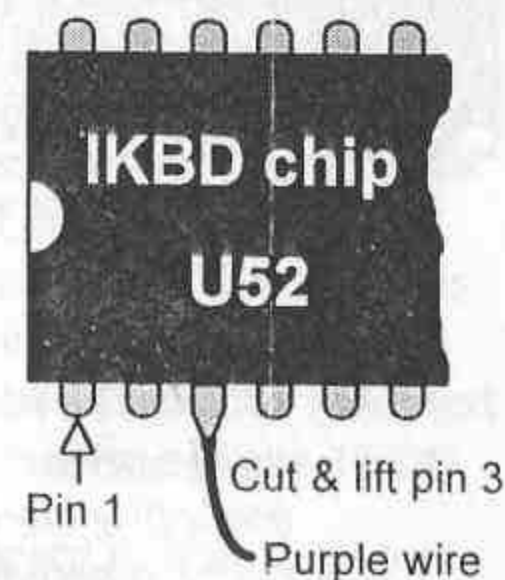
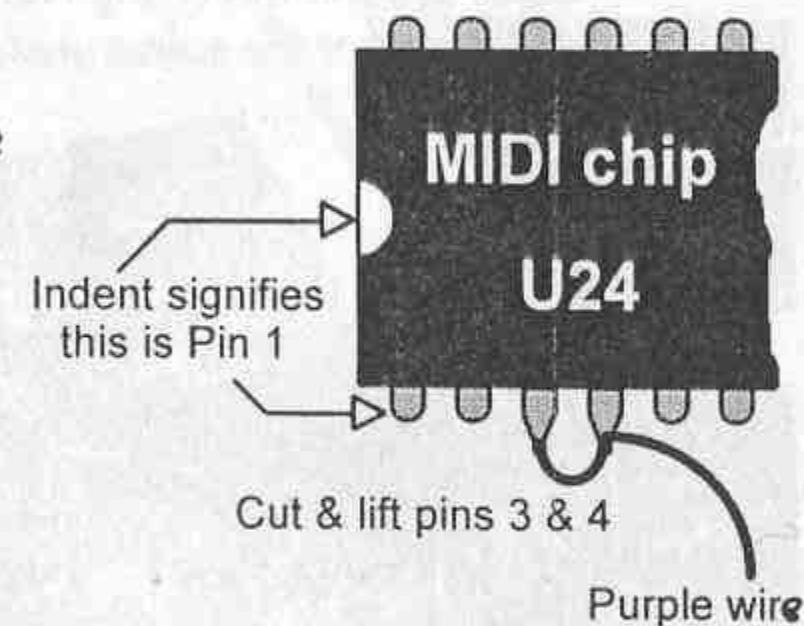

- (f) Locate inductor L102 (close to U64 and U65) and remove it entirely from the PCB.

Don't worry about damaging this device. It can always be replaced by a wire loop if the fitting needs to be reversed.

- (g) Solder the **GREY** wire to the **RIGHT** solder pad of where L102 was situated. Keep this wire as short as possible.

- (h) Solder the **YELLOW** wire to the **LEFT** solder pad of L102. **DO NOT SHORTEN THIS WIRE YET**, as it's a temporary measure implemented **PURELY** for testing the keyboard patch (next section)

This wire will be moved to its correct location later on.

- (i) Solder both the **WHITE** and **THIN BLACK** wires (**NOT** the thick black wire!) to the nearest ground location. The best place is the outer ground rail at the edge of the Falcon PCB. **DO NOT SHORTEN THESE WIRES YET**, as they are connected here temporarily to force the Nemesis card to be turned **OFF** during the first test, which is covered in the next section.

Both these wires will be moved to their correct locations later on.

- (j) Solder the **THICK BLACK** wire to the **NEGATIVE** pole of the 4700uF smoothing capacitor - the same position used for the Buffer card earlier.

Make sure you do not dislodge the Buffer card wire when you do this.

Keep both the thick black and red wires as short as possible.

- (k) Solder the **THICK RED** wire to the **POSITIVE** pole of the 4700uF smoothing capacitor.

- (l) Ensure the remaining unconnected wires are tied together and kept away from all exposed metal in the Falcon, for the purposes of the test in the next section.

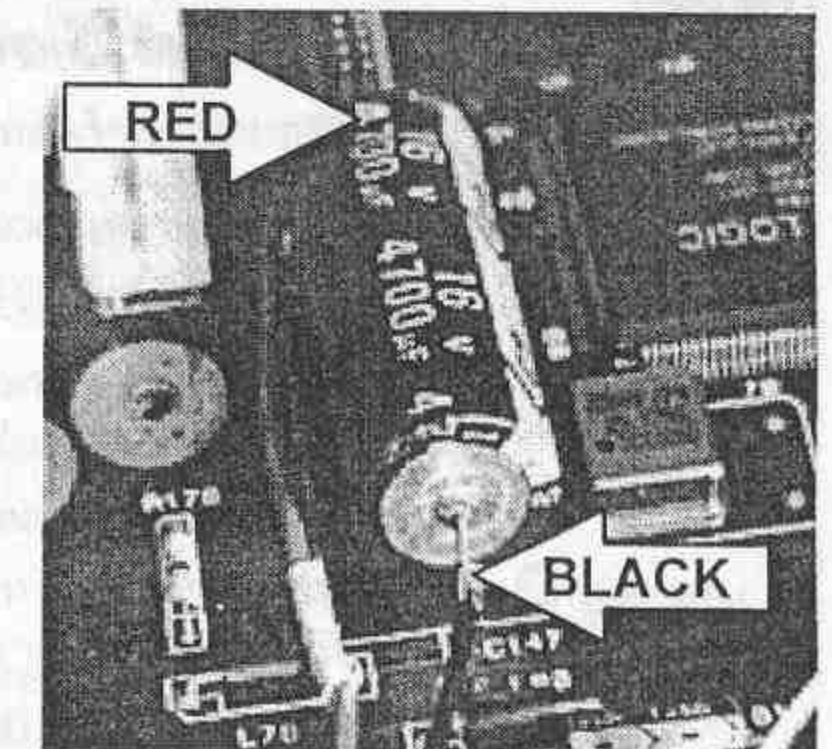
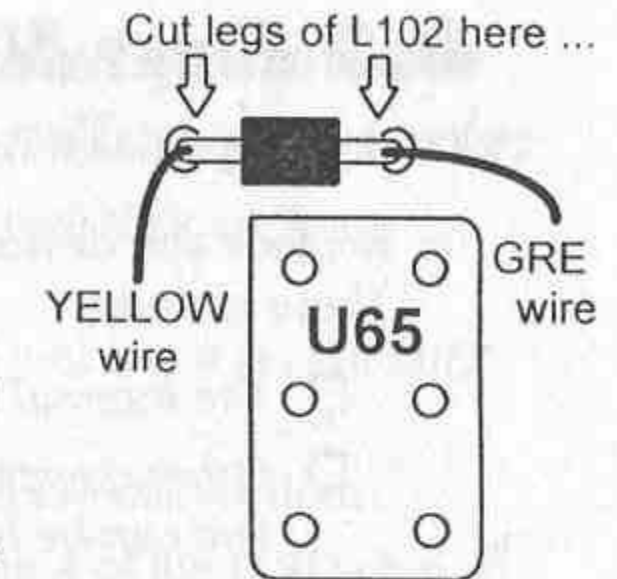



## 8.2 FIRST NEMESIS TEST - THE KEYBOARD PATCH

The keyboard patch now requires testing to ensure it is correctly installed.

- Replace any devices which may have been removed for easy-access to the PCB. These include:
  - The internal IDE hard disk, power supply, keyboard, mouse and monitor.
  - Other devices (like the floppy disk or expansion cards) are not so important, and can be left out for the purposes of this test.
- Ensure all wiring is tidy, and no solder dust is left on the PCB. Use a small brush to clean the PCB.
- Power up the Falcon, and watch the screen.

### 8.2.1 If the machine boots up as normal and the mouse/keyboard respond correctly:

Good news. Power off and go straight to the next section.



### 8.2.2 If a persistent black screen is displayed (after about 5 seconds) then:

Power off *immediately* and check your wiring.

- Check the memory board is fitted correctly.
- Ensure that the connections to the L102 solder pads are correct.
- Check to make sure neither end of L102 is connected to ground via stray solder on the underside of the PCB, or from the severed pins of L102.
- Ensure the 2 black wires (thick and thin) are correctly connected.
- Ensure the +5v wire (thick red wire) is not shorting to ground either at the Nemesis card itself or near the 4700uF smoothing capacitor.
- Check the MIDI & IKBD chip connections. See 8.2.3 below for more details on troubleshooting at these locations.
- Re-read the instructions to ensure you have not misunderstood anything.

### 8.2.3 If the machine boots up normally, but the mouse & keyboard are NOT responding properly;

- Check the MIDI and IKBD chip connections. Make sure they are not accidentally grounded or shorted to any other pins.
- Make sure the isolated pins (pin 3 on the IKBD and pins 3 & 4 on the MIDI chip) are not touching the solder pads below.
- Check for stray solder or other errors present around the connections.

If all else fails, it is possible that the Falcon requires having pin 4 of the IKBD chip (U52) cut, lifted from the motherboard, and joined to pin 3 (exactly the same procedure as with the MIDI chip). See 8.1 IKBD & MIDI PATCHES.

If you still cannot find any faults, reverse all solder connections, replace L102 with a wire loop and re-connect the MIDI and IKBD chip pins to the PCB. Perform the power-on test again. Once everything is working, retry this section of the installation process.

## 9. THE CPU/BUS ACCELERATOR

In this section, the Nemesis switching lines are installed along with the main acceleration modifications which allow the machine to operate at high speeds.

- Remove the **YELLOW** wire from the left pad where L102 was originally situated.
- Carefully solder the **BROWN** wire to the **BOTTOM** solder pad at R234.
  - Make this wire **SHORT** - it is particularly sensitive to interference.

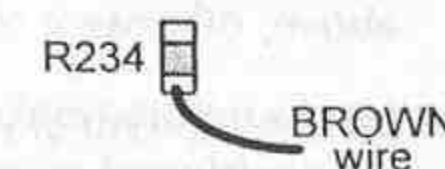

- Locate pin 5 on the MIDI chip (U24), where pins 3 & 4 were previously modified. Remove the **THIN BLACK** wire from its temporary location to the outer ground rail and solder it to pin 5 of the MIDI chip instead.
  - Do not cut pin 5 as you did with pins 3 & 4, just solder the wire directly on. Shorten the wire as usual, to keep things tidy.



(d) Locate pin 5 on the IKBD chip (U52). Remove the **WHITE** wire from its temporary location at the outer ground rail, and solder it instead to pin 5 of the IKBD chip.

- Do not cut pin 5 as you did with pin 3, just solder the wire directly onto the pin. Shorten the wire as usual, to keep things tidy.

(e) If the 48MHz oscillator block is not fitted to the Nemesis board, then do so now.

- Before fitting any oscillator block to Nemesis, remove pin 1 as close to the body as possible. See the diagram (below) to identify pin 1 correctly.

### Pin 1 of the oscillator - MUST be removed!

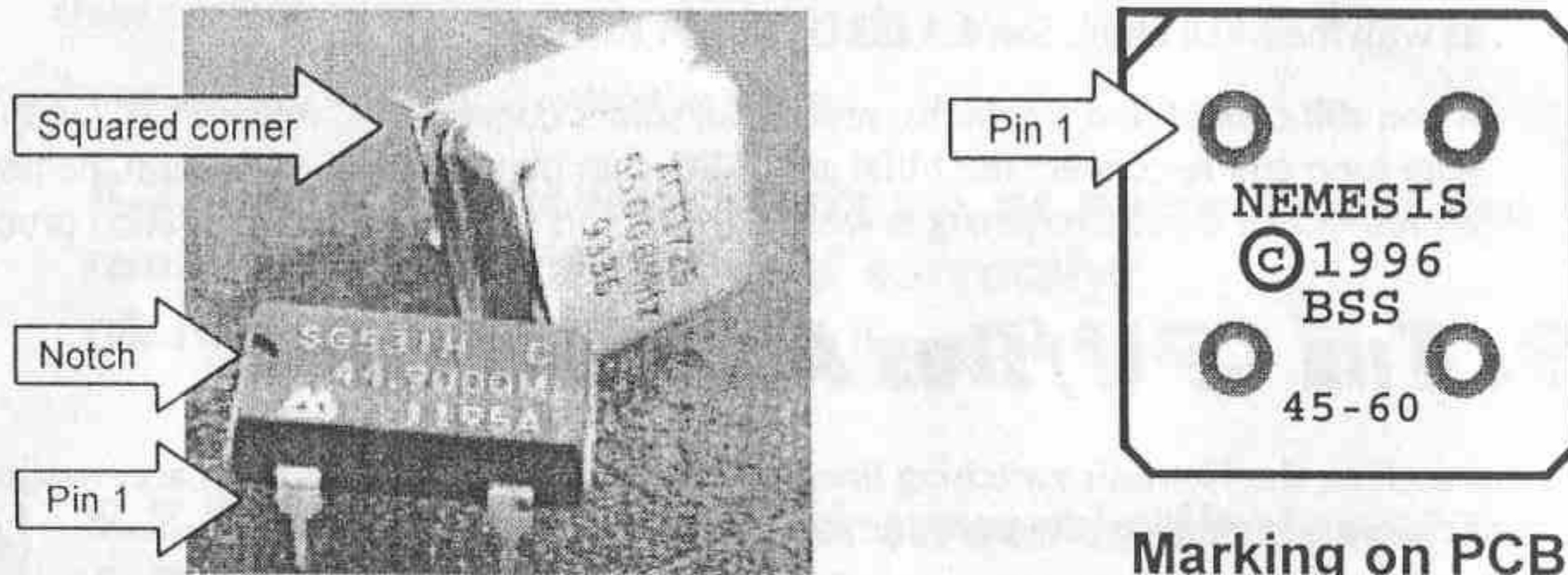

Marking on PCB

## 9.1 2ND NEMESIS TEST - THE 3 NEMESIS SPEEDS

Here we can attempt our first rudimentary 'stability' tests using the supplied *NemBench* software. Using this, we can ensure that Nemesis is actually working properly (so far).

Unfortunately because the RGB patch is installed **LAST**, it will be necessary for users of RGB monitors & TVs to install this section before testing the machine at 20/40MHz or above, otherwise the screen display will be unviewable for the purposes of these tests.

- (a) As before, make sure all solder dust is removed and that any spare wires are positioned away from the Falcons PCB.
- (b) Replace the following peripherals:
- Internal IDE hard disk, power supply, keyboard, mouse, floppy drive, monitor, and anything else needed for a basic testing session with software.
  - DON'T FORGET TO REPLACE THE TOP PLASTIC COVER!!!**

(c) Power the machine on and check it is functioning correctly. If not then;

- Check the installation for any obvious errors. If none are found try removing R234 altogether and soldering the **THIN RED** wire to the **TOP** pad of R234. This may cure a potential problem on some machines. See **APPENDIX 1.1.4** for more details.
- See the section - **FIRST NEMESIS TEST** - if the Falcon does not work as expected. For reference, the only changes made in the last section were the Nemesis on/off switching lines and the direct-drive clock feeds to the Combel chip. These can easily be reversed individually to locate the problem. If it is necessary to revert back to the previous section, the **BROWN** wire should be removed and the **YELLOW** wire needs replacing at L102.
- Check that the oscillator block is correctly installed. If incorrect this can damage the oscillator, and lead to power failures in other areas of the Falcon.
- If nothing else works, switch the Falcon off and remove the oscillator. If this helps, then the oscillator is either incorrectly installed, faulty or damaged.

(d) With the Falcon working, run NEMBENCH.PRG program from the Nemesis disk. It does take some time to perform all tests, but the figures should all report 100%.

- If the figures are **NOT** 100% (i.e. they are 125% or 150%) then Nemesis is turned on. Re-examine the fitting of the switching lines (the thin black and white wires connected to the IKBD and MIDI chips).
- Some software installed for another accelerator may be interfering with Nemesis operation. If so, remove the offending program or CPX and try again.
- If necessary (and to test whether there is interference with some other AUTO-loading software) power down the machine and remove the IDE or internal SCSI cable. Now try running NEMBENCH from the floppy disk. Assuming the installation is correct, the figures should now read 100%.

(e) Run the **NEM\_LO.TOS** program to switch Nemesis on - this should now switch Nemesis to provide a 20MHz CPU and 20MHz Bus.

- If the machine crashes, then try again. If it keeps crashing then there may be a problem with the wiring. If however you just get a black screen, then it is most likely that the 40MHz oscillator is damaged. You may need to get your Nemesis card repaired or replaced under these circumstances.



(f) With Nemesis running at 20/40MHz, run **NEMBENCH.PRG** to find out if the Falcon has been accelerated. The figures should all read 125%.

- If the figures are still 100%, then you have either got your thin black and white wires connected the wrong way round, or they are shorted to ground for some reason. Check the wiring again.

(g) Run the **NEM\_HI.TOS** program to switch into turbo mode. This should now switch Nemesis to provide a 24MHz Bus and CPU.

- If the machine produces a black screen, the 48MHz oscillator is either damaged, or fitted incorrectly. Re-examine the oscillator fitting instructions. If this is correct, the oscillator may need replacing. There is a possibility of a faulty Nemesis PCB, but this is unlikely.
- If the machine crashes every time you switch to turbo mode, then there could be a small problem in the wiring. This could be a result of interference, or because pin 1 of the 48MHz oscillator has not been trimmed properly before fitting. There is a very slim chance that your machine is not happy with a 24MHz (or higher) bus, but this is highly unlikely.

If your machine really is unstable at 24MHz, then it would normally assert itself in a much more subtle way than immediate crashing. Problems usually appear in the form of DMA SCSI disk errors, which Nemesis fixes in all but the most extreme cases, and occasionally with audio interference during sample playback. In very extreme cases, the machine may crash after a sustained period of use if the internal temperature becomes too high. See later sections for more detail on stability issues.

(h) Run **NEMBENCH.PRG** and make sure all of the figure read approximately 150%.

- If the figures are still 125%, the **THIN BLACK** wire connected to the MIDI chip could need some attention. Ensure the wire is not touching anything it shouldn't, and that it's correctly connected to pin 5 of the MIDI chip.

## 9.2 ACCELERATING THE DSP

This section is optional, and can be ignored by anyone not requiring a fast DSP, however it is a relatively easy modification, and worth implementing for users of our other products like Apex Media, Audio & Alpha.

- (a) Locate the DSP chip (U38) below the Floppy drive.
- (b) Using a very fine scalpel, cut the track joining pin 74 of U38 to the bottom-right solder pad of U37.
  - Make sure the DSP is completely isolated from U37.
- (c) Using the scalpel, scrape the solder-resistant coating away from the remaining track connected to the DSP. As a wire is soldered here, make sure there is enough exposed copper track to make an easy connection.
- (d) Solder the **BROWN** wire to this newly exposed PCB track, avoiding contact with surrounding pins of the DSP, and especially the solder pad at U37.
  - Avoid running this wire anywhere near the memory board.
  - Trim the wire as short as possible. There is no easy way to implement this neatly, so the best option is to tack the wire onto the PCB at various locations along it's length using tape or a little glue.
- (e) Test the DSP using the **DSPBENCH.PRG** supplied. It should read 100% when Nemesis is turned off, 125% when Nemesis is at 40MHz, and 150% at 48MHz.
  - If the DSP is not working, check your wiring, and perhaps even reverse the modifications made in this section if there is no success.

## 9.3 DOUBLE-CLOCKING THE FPU

This section is optional but is not really advisable for use with a 16MHz co-processor, but feel free to experiment. 25MHz rated FPU chips should work at 32 or 40MHz, and possibly even at 48MHz, but a 33MHz rated device is really required for reliable operation at the higher speeds.

- Ignore this section if an FPU is not fitted, and you have no intention of fitting one in the future. This also applies to machines with an Afterburner040 fitted, as they cannot make use of the Falcons FPU chip anyway.
- (a) Remove the old **ORANGE** wire connecting the Buffer card to the top solder pad of R221 (near the CPU).



- The orange wire needs to be removed from the Falcon PCB, but can be left attached to the Buffer card providing the exposed end does not touch any part of the Falcon. If necessary bind the end of this wire with some tape.
- (b) Solder the **ORANGE** wire from the Nemesis card to the top pad of R221, making sure it is trimmed to the minimum required length beforehand.
- (c) Test the FPU using **NEMBENCH.PRG**. Don't worry if the figures are not exactly double what you expect, as this is normal. Make sure the figures are consistent (i.e. after repeated tests they do not fluctuate significantly) and there are no unexpected crashes during the individual FPU tests, which indicates an over-stressed FPU.
- If in doubt, you can reverse this section by removing the orange Nemesis wire, and replacing it with the original orange Buffer wire. This returns the FPU to single-clocked (20 or 24MHz) mode.

## 10. VIDEL MODIFICATION (OPTIONAL)

This section is intended for when Nemesis is used with an RGB monitor or TV. As most users will be using a VGA monitor, the switch or resistor (as mentioned below) are not supplied as standard, but can easily be sourced from ourselves. We advise that only *miniature* SPST or SPDT switches are used due to the lack of available space.

### 10.1 INSTALLATION

- (a) Locate the Videl chip (U34), which can be found immediately to the **RIGHT** of the large 4700uF capacitor used by the Buffer and Nemesis for power.
- (b) Using a sharp knife or scalpel, cut the track joining pin 73 of U34 to the top-right solder pad beside oscillator U41.
  - Ensure this pin is completely isolated from U41.
- (c) Solder the **GREEN** wire to the solder pad at U41.
- (e) Scrape the solder resist from the track connecting to U34 and solder the **BLUE** wire to the newly exposed track.

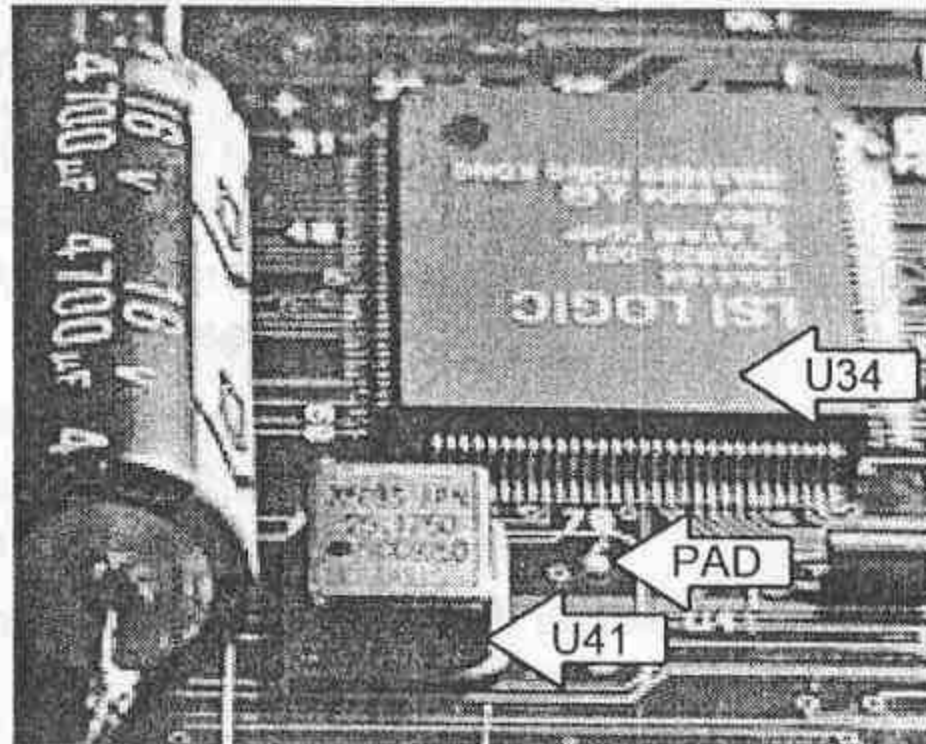

## 10.2 SWITCHING

- (a) Find a suitable place to mount the switch in the **BOTTOM** plastic case.
  - Immediately to the right of the keyboard connector is a good place.
  - Make absolutely sure before mounting the switch that it will not interfere with any part of the Falcon motherboard, or the metal shieldings.
- (b) Solder a 10K ohm resistor to the **RIGHT** pin of inductor L117, which can be located to the bottom-left of the motherboard.
  - As this pin supplies +5V, keep the legs of the resistor short and ensure that they cannot come into contact with another part of the Falcon - **PARTICULARLY** the metal shielding!

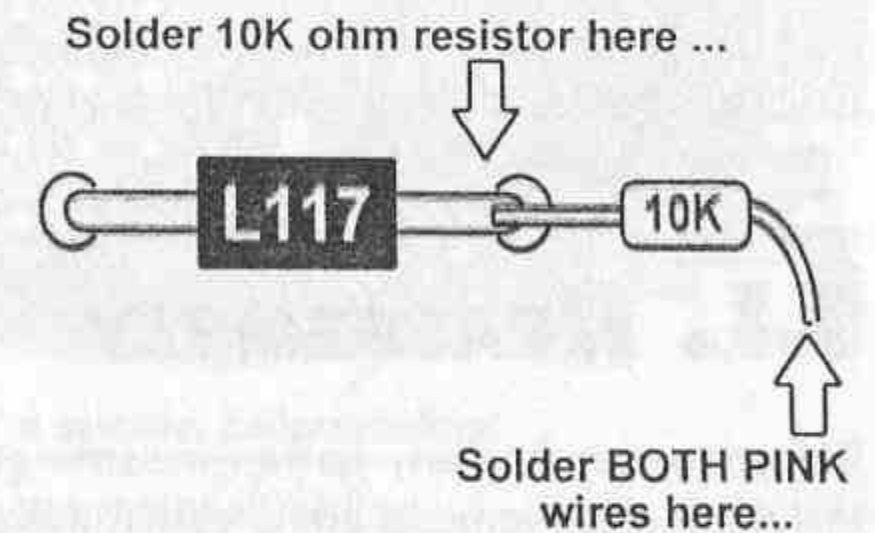

- (c) Shorten the **PINK** wire to suit and solder it to the other end of the resistor.
- (d) With the remaining length of **PINK** wire, solder this also to the same resistor leg (i.e. join both **PINK** wires) and the other end to the centre switch contact.
- (e) From one of the other switch points, solder a short length of **BLACK** wire (you should have some spare!) to the outer rail of the Falcon motherboard.

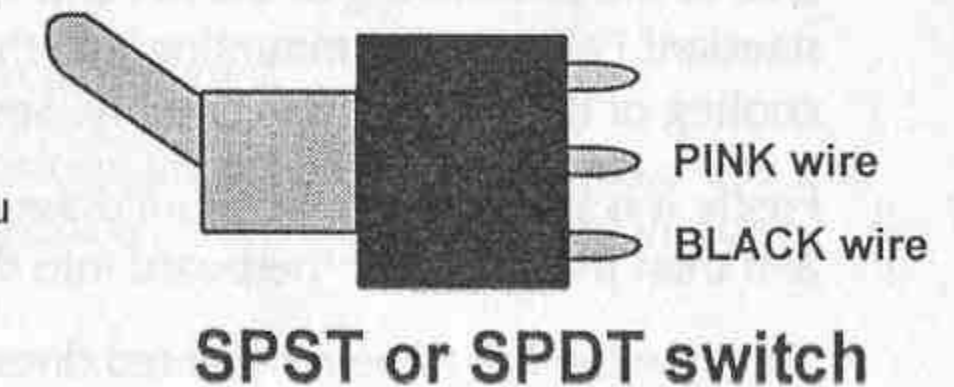

## 10.3 VIDEL TEST

After replacing all necessary components; hard drive, PSU, etc. connect the RGB monitor or TV and power up the Falcon. If you do not get a stable display, then;

- Toggle the switch to the 'ON' position!
- If this makes no difference, there is a possible wiring fault;
- Check that the track leading from U34 to U41 is definitely cut.
  - Check that all the wires are correctly soldered.



## 10.4 RGB Sync Fix (OPTIONAL)

Under certain circumstances (and on certain VGA monitors), an effect can be seen when using certain utilities - most conspicuously the 24-bit APEX Viewers.

This is an entirely optional modification and is really intended for users having a standard 14" VGA monitor, however it is still worth doing as a matter of course whatever monitor is being used.

Locate and remove the two inductors L29 and L30. These can be found immediately in front of the 19-way monitor socket. Taking two 75 ohm resistors, solder these in place of the two inductors.

## 11. REASSEMBLY

Before proceeding any further we strongly advise that modifications to the Falcon and the installation of Nemesis are checked thoroughly and that no scraps of solder are left inside. After you are satisfied that the installation is correct, the Falcon computer can be reassembled (the reverse of the dismantling procedure - see earlier notes).

### 11.1 REFITTING FAN (OPTIONAL - STD. FALCON ONLY)

Due to the positioning of the fan and the poor air circulation this provides inside a standard Falcon case, mounting it to the top metal shielding will improve the overall cooling of the Falcon considerably. See also **Appendix 1.1.1 Temperature Problems**.

Firstly it is best to partially rebuild the machine by refitting the lower metal shielding, and then the entire motherboard into the lower plastic case.

To allow the fan to be remounted does require the speaker being removed and a 38-40mm diameter hole being cut into the top metal shielding (see following diagram).

Two of the ventilation holes can then be used for mounting the fan. Before bolting the fan into place, shorten the screw threads by about 2mm.

Next, the red and black fan wires need to be soldered onto the PSU. It is advisable to lengthen the leads by about 10cm, making sure the joined wires are well insulated. Now solder the **RED** lead to the **BLUE** connection (+ 12 volts), and the **BLACK** lead onto any of the three **BLACK** connections (Ground).

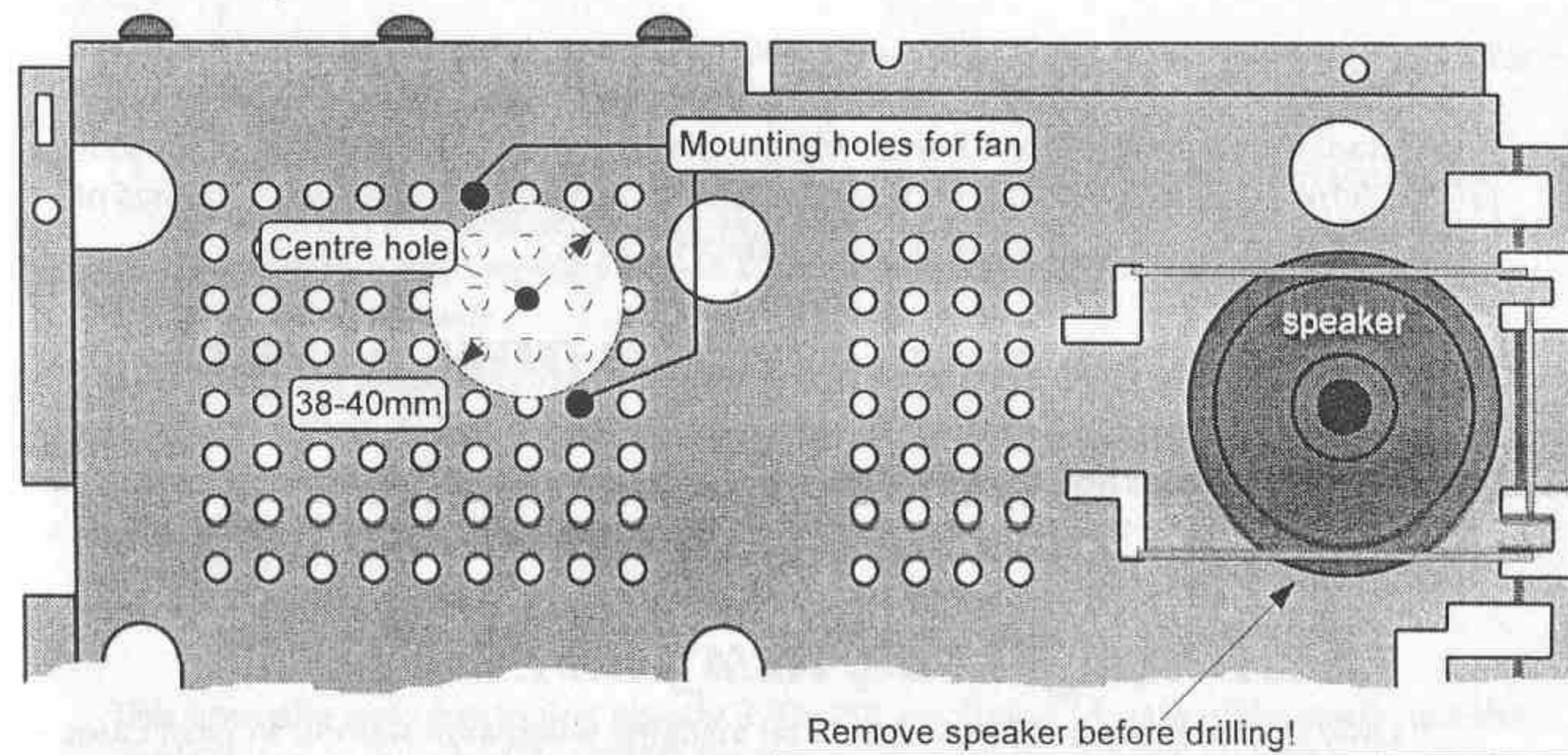

Above: Modification to the top metal shielding

### 11.2 REBUILDING NOTES

- When replacing the floppy drive, take **extra care** to ensure the brass spacer is correctly located. If not, this could easily short out components, damage the Falcon, and necessitate an expensive repair bill!
- Make sure the IDE connector is the correctly inserted.
- If the fan has been refitted to the new position (as detailed above), make sure that the screws do not touch any live component with the metal shielding in place.

## 12. SOFTWARE

For the purpose of software installation, the task of correctly configuring the AUTO folder becomes increasingly easier if a Boot Manager is used. There are several different types of this program, but perhaps the better known ones are X-Boot, Super Boot and SToop.

### 12.1 NEMBENCH

This is used to determine the viability of the installation by testing the various installed components at the different Nemesis clock speeds.



## 12.2 DSPBENCH

A companion program for NemBench which permits the accurate profiling of the DSP (56001) chip. Using DSPBench with Nemesis set to 40MHz would produce figures of 125% and with Nemesis at 48MHz this produces 150%.

## 12.3 NEMESIS SPEED SETTINGS (NEM\_XXX.TOS)

These files can be placed in the AUTO folder. As described below, they can either be [Auto Started] or launched from the Desktop. In any event, switching between the various Nemesis speed modes can be done from the Desktop without the need for rebooting the Falcon.

### 12.3.1 NEM\_HI.TOS, NEM\_LO.PRG

Only one of these programs should be installed when auto started. In most cases we envisage that the NEM\_HI.PRG file would be used most of the time.

When used with a Boot Manager, either program must be placed immediately before NEMESIS.PRG (see 12.5 SPEED DETECTION). Setting the [Auto Start] feature to use either the NEM\_HI or NEM\_LO program is also possible.

If a Boot Manager is not available, then the NEM\_HI or NEM\_LO files can be run from the Desktop, or linked to Function keys using <Install Application...> from the <Options> drop-down menu bar.

### 12.3.2 NEM\_OFF.PRG

Switches Nemesis back to its native mode of 16/32MHz. The only time this file is really needed is when running games or demo programs that specifically use the timing of the Falcon as a reference. Disabling either NEM\_HI or NEM\_LO in the AUTO folder will also enable standard operation of the Falcon.

## 12.4 HIGH-RES. TRUE COLOUR (HRTC.PRG)

HRTC needs to be placed in the AUTO folder **AFTER** NVDI in the running order and is an invaluable utility for boosting the Falcon true-colour resolution to 640x480 when using Nemesis at the higher speed of 24/48MHz. Great benefits can be seen, for instance, when using CAB (the Atari Web browser) as the decoding and viewing of true-colour JPEG images become significantly faster. Many other programs can also take advantage of this video mode, such as DTP and art programs.

Although using HRTC does inevitably slow down the Falcon operation, our tests show that the speed is **still faster** than a standard (16MHz) Falcon!

- A new version of **APEX Media** which now permits 640x480 non-interlaced true-colour on VGA monitors, is now available. Please contact us for details on how to upgrade your existing copy of APEX Media. Please have the version number and serial number ready.

After installing HRTC correctly in the AUTO folder, reboot the machine. To set the enhanced true-colour resolution from the Desktop, click on the <Options> drop-down menu and select <Set Video...>. The various options are set to;

Colors: True Color  
Columns: 40  
Double Line: Off

This normally switches to that ghastly 320x480 resolution (does anyone **really** use this mode?!), but is 'hijacked' by HRTC for the purpose of achieving 640x480 true-colour.

- A few anomalies can be seen when using HRTC. Some buttons within programs can appear to be 'blacked out', but this should only apply to pre-selected ones.
- The right and left borders of GEM Windows are half the normal width. This is because GEM assumes that a resolution of 320 pixels wide is being used, rather than 640, and is drawing the Windows accordingly.

## 12.5 SPEED DETECTION (NEMESIS.PRG)

Can be placed anywhere in the AUTO folder, but **BEFORE** the Speed Setting program, i.e. NEM\_HI.PRG or NEM\_LO.PRG. Placing NEMESIS.PRG as the first file after the Boot Manager (if used), will speed up the AUTO-loading process.

## 12.6 VIDELITY (NOT SUPPLIED)

Vidality is a 'must have' option for the Nemesis user. This program allows even higher resolutions than the 640x480 true-colour afforded by HRTC, but is a highly featured program for configuring standard or 'Nemesised' Falcons to achieve higher resolutions at any colour depth. Full support is also given to the Blow Up and Screenblaster external video hardware to achieve even higher resolutions.

Using Vidality with Nemesis it is possible to realise true-colour resolutions of 720x528 on a **standard** VGA monitor, although a multisync could take this further to 768x576!



## APPENDICES

### 1. STABILITY ISSUES

With so many differences in the Falcon it is impossible to say how each installation affects the various ones that exist. The only thing we can say is that Nemesis has already been tested on a number of machines at the highest specifications without any problems.

#### 1.1 General System Stability

If your Falcon crashes frequently (or even infrequently but with no apparent cause) or you would like to accelerate Nemesis beyond the standard 48MHz specification, this section should act as a guide to tracking down problems which may be impacting on the overall reliability of the card. It also acts as a good (secondary) guide to solving DMA problems, in addition to the next section, since DMA problems can be aggravated by other innocuous things.

##### Temperature Problems

If the Falcon is overheating, due to high ambient room temperature and/or bad air circulation, then it is possible that the Falcon will begin to crash at 48MHz or above. It must however be made clear that this can only happen when the chips get very hot, and room temperature alone is not enough to cause problems.

Machines with no fan, bad air circulation (make sure nothing covers the vents on the top plastic case!), or with extra hardware installed could raise the temperature enough to have an effect. This problem expresses itself in the form of inexplicable crashes after prolonged use, with increasing frequency unless turned off and allowed to cool.

The only cures for overheating is to either fit a fan (if not already fitted), raise the Falcon from the desk to increase circulation, or fit a fan to the top metal shielding above the power supply (preferred - see **11.1 Refitting Fan**).

##### Interference

Long wires lead to interference problems - especially the wires leading from the Buffer to the DMA chip, and from Nemesis to the DSP. Moving these wires to different locations may be necessary to eliminate noise in the system. This is not normally necessary, and should be considered a **LAST RESORT** if Nemesis doesn't work reliably. Try to keep 'signal' wires from Nemesis (**RED, YELLOW, BROWN & ORANGE**) away from components like the memory card, CPU and other 'hot' silicon devices which produce RF interference.

#### Grounding & Power

The following modifications shouldn't normally apply, but the Falcon does suffer from a chronic case of bad PCB design which may aggravate the situation.

Nemesis will react badly if not supplied with a clean power source. This should be taken from the smoothing capacitor (C147) near the power supply, but other locations are possible.

We do not recommend changing the location of the +5v Nemesis/Buffer power sources (**RED** wire), but the Falcon can have serious problems supplying a clean Ground to most of its components. Nemesis reliability can be improved (especially at very high speeds) by connecting additional ground wires from the negative pole (**BLACK** wire) of the 4,700uF capacitor to other locations on the PCB. These include;

- Pin 14 of U20 - the location used as a Ground point for the 150pF capacitor. U20 may not have a clean zero volt supply, and a direct ground may help.
- A ground wire between the 4700uF capacitor, and the outer ground rail of the Falcon PCB. Small voltage variations between these locations can exist and eliminating them could improve matters.

#### Driving the CPU & BUS with a clean, reliable clock

The wire feeding location R234 actually supplies the master clock to the rest of the Falcon, and should be kept short and tidy. The longer the wire, the more interference might affect the card's operation.

The standard way of supplying the clock is to the **BOTTOM** of R234, with the resistor still in place. It is however possible to remove R234 and feed the **TOP** pad of the missing resistor with the **THIN RED** wire and the **BOTTOM** pad with the **BROWN** wire. This separates the VIDEL and COMBEL clock sources, reducing signal leakage from these chips and supplying a stronger clock source to drive them. The actual difference this modification makes is debatable, but has resulted in some improvement in a few cases where 55MHz was not achievable before. This modification is **ONLY** recommended if you're having problems with stability, but this method **CAN** be used to push the Falcon to higher clock limits if required.



## 1.2 SCSI and Audio DMA Problems

The most frequent problem encountered when attempting to accelerate the Falcons bus hardware is caused by the DMA circuits. The problem is most noticeable when reading or writing to a SCSI device, or during Audio playback with direct-to-disk recorders.

Nemesis tackles the problem from several angles at once, but the problem is so deeply buried in the Falcon design that a complete cure is not always possible - and in a few cases it may be necessary to go beyond the standard installation to achieve reliability. This is not the case with most Falcons, but a few users could encounter this situation, and is therefore detailed here for this purpose.

The first part of the problem is identification - establishing the existence and extent of DMA faults at the various clock speeds. The easiest way to find SCSI DMA problems is to use a disk consistency checker like Diamond Edge, or a file comparison utility like TREE\_CHK.PRG which is part of the Kobold software package. TREE\_CHK does appear to be the most effective program, as random data 'deviations' are detected very quickly in the form of 'non-equal' file compares. Repeated tests should result in random results if the problems are in fact 'real', and not just down to simple hard disk problems.

It is important to note that **MOST** Falcons have DMA problems even before modification, but these are not always apparent in the usual video modes since the stress placed on the BUS/DMA hardware is low enough to avoid errors. This however is not always true with some Falcons giving problems at 640x480x256 colours, without stressing the machine.

If the DMA hardware **IS** causing problems, 'tweaking' Nemesis can improve the situation. These tweaks can be very system-specific in the worst cases, but it shouldn't be necessary to try more than 1 or 2 of the following modifications before improvements can be achieved. The DMA hit-list, in order of simplicity, is as follows;

- (a) Use a lower Nemesis clock speed. This is not an ideal solution, but it is easy!
- (b) Fit the 82pF capacitor between U20 pin 14, and U36 pin 110 (as described earlier).
- (c) Fit the second capacitor (150pF).
- If the DMA problems still persist, then matters can be taken a little further;
- (d) Replace the capacitor(s) with a 1K ohm resistor. This is rarely required, but can be most effective on machines equipped with Afterburner040 cards.
- (e) Desolder the white Buffer wire from pin 110 of U36, and remake the broken track to this pin. Try the experiments above to see if there is any improvement.

In very rare cases, it may be necessary to use a different buffer chip - but this is very rare indeed! Contact Titan Designs for details if this looks like the only remaining option.

## 2. COMMITMENT FROM BLACK SCORPION SOFTWARE

Black Scorpion Software are the leading software developers for the Atari Falcon030.

A brash statement? Well, our competitors may think so, but when you consider the high standard of the products already in production, and those which are 'waiting in the wings', it is very hard to argue against!

From BSS Debug, BSS have gone on to develop APEX Media, APEX Intro, APEX Alpha, APEX Audio, Videlity and, of course, Nemesis. In fact we are probably the only software developers to create hardware for a specific purpose - namely Nemesis to work with APEX Alpha!



### APEX Media

Proved to be ground-breaking software when first released, and is still regarded as one of the best art program for the Atari Falcon (even though it's strictly an Animators tool!). APEX Media now support 640x480 true-colour when used with Nemesis.

### APEX Intro

An off-shoot to APEX Media which is every bit as powerful an Animator as its big brother, but having a few key features disabled, although selling considerably cheaper.

### APEX Alpha

Currently under development. 'Alpha' promises to be every bit as earth-shattering as 'Media' was, back in 1995, with features including 32-bit image processing with 8-bit Alpha-channeling, Image processing, Compound filtering, Chroma-key, anti-aliasing, etc.

### APEX Audio

Currently under development. The first music-based application from BSS, which includes 24-bit sampling capability, Waveform enhancement technology, real-time resampling for record and playback (6KHZ to 99KHZ, Direct-to-Disk, Filters, Wave Generation studio.

### BSS Debug

The first ever program by BSS. A superb Debugger for any dedicated Falcon programmer.

### Videlity

Screen enhancement software with complete flexibility over all parameters, and offering additional support for BlowUp and Screenblaster external hardware.



### 3. INTO THE FUTURE

The Afterburner040 provides an incredible performance boost to the standard Falcon and when including Nemesis a speed increase *in excess of 9 times* can be seen!

As with any accelerator board, software compatibility is one of the most important issues, and Afterburner, in our opinion, provides this by allowing the original Falcon DSP to be utilised fully with all our software. So if you want to join the ever growing number of power users, contact Titan Designs for more details.

#### M68040 ToolKit

Such is the commitment of BSS to the Falcon platform, M68040 ToolKit has been developed specifically for the Afterburner. This amazing group of utilities enables complete adjustment of the various parameters to provide rock-steady performance under virtually any operating condition.

#### And we haven't stopped yet!

As a company solidly behind the Atari Falcon, we already appreciate that the market has swung towards the dedicated Falcon user who requires power applications. As such there is a very bright future for the platform, as the Falcon moves towards becoming a high-end, professional graphics/music solution.

Although we are unable to divulge our future plans, a graphic-based hardware peripheral and a professional audio tool are on the drawing board. Both these products will be fully compatible with a standard Falcon, and could provide the way forward for the whole Atari Falcon concept.

David Encill & Douglas Little

Directors, Black Scorpion Software Ltd.

December 1996

## ADDENDUM

### NEMESIS PRINTING

At the last minute we picked up a rather fundamental problem with printing when using Nemesis at 48MHz. This normally transpires as garbled printout.

At the time of writing we believe the problem has been solved using a software patch. If this is the case, the relevant file is enclosed on the disk, called;

#### NEM\_PRNT.PRG

Place this file inside the AUTO folder, making sure it's *one of the last files* in the running order.

### SPEED INDICATION CIRCUIT

This small section is a last minute addition to the manual, and is useful to those Nemesis users who would like an indication of the current speed state. Due to lack of time, we are unable to provide a circuit diagram, but will post information for this on 42BBS, Cix and NeST, when ready. Alternatively, contact us for more information.

Using a bi-colour, or tri-colour LED means that different colours can indicate either 40MHz or 48MHz, with an off state meaning Nemesis is inactive. An alternative method is to use two separate LED's with an in-line resistor to one leg of each LED.

#### Signal Pins

The pins used to indicate the current Nemesis state are pin 5 of U24 (48MHz), and pin 5 of U52 (40MHz).

- Make absolutely sure that no part of the circuit shorts to ground (except the ground pin, of course!). If this did happen, the Falcon could get damaged.

Tel: +44 (0)121-693 6669

Fax: +44 (0)121-414 1630

e-mail: 100345.2350@compuserve.com

Web: <http://ourworld.compuserve.com/homepages/TITANWEB/>