

STC 504
THERMAL TRANSFER
SERIAL DOT MATRIX

Contents

1. Atari Parallel
 - 1.1 Control Codes
 - 1.2 Print mode table
 - 1.3 DIP SW Setting
 - 1.4 Character table

2. IBM
 - 2.1 Control Codes
 - 2.2 DIP SW Setting
 - 2.3 Character table

3. Commodore
 - 3.1 Control Codes
 - 3.2 DIP SW Setting
 - 3.3 Character table

4. Apple IIc
 - 4.1 Control Codes
 - 4.2 DIP SW Setting
 - 4.3 Character table

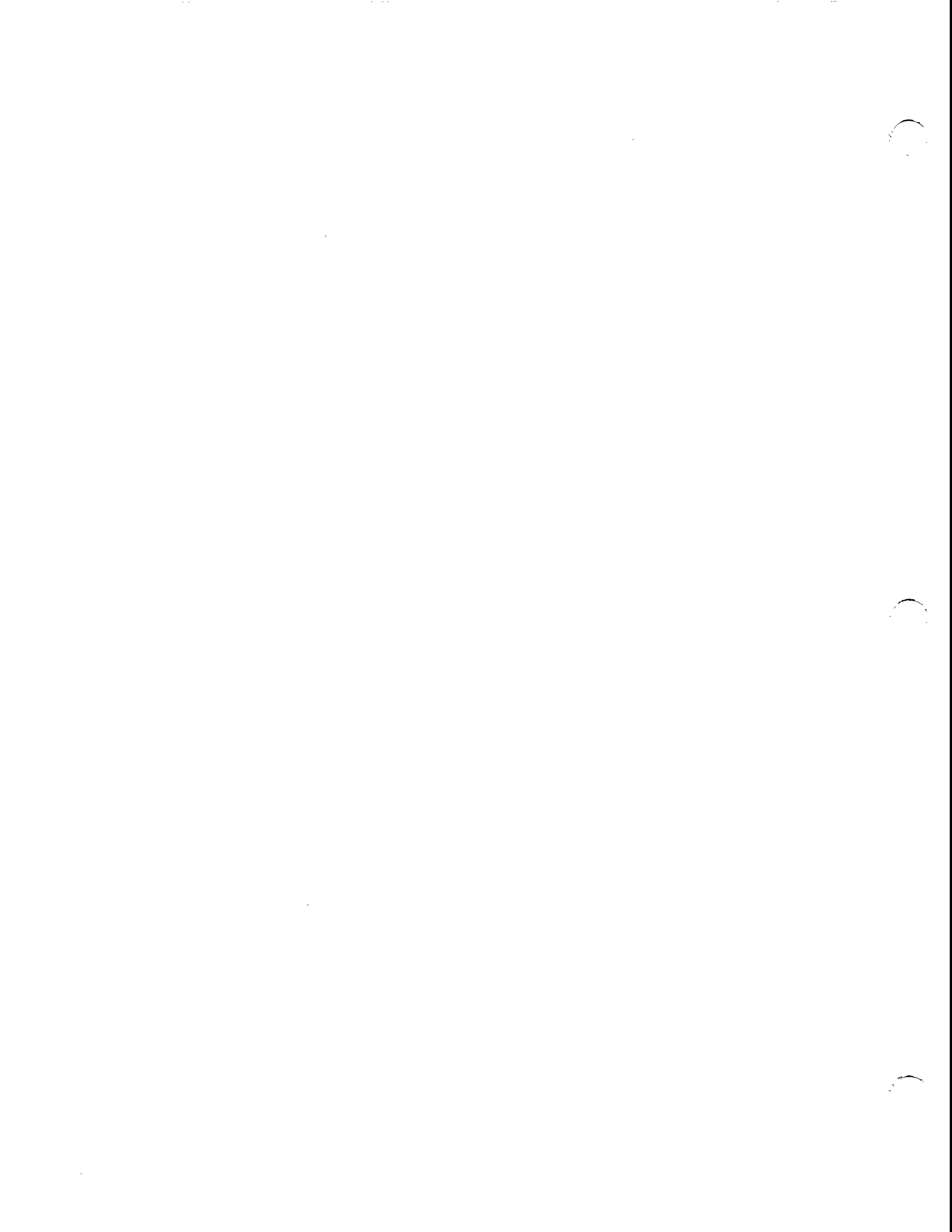

1. Atari Parallel

1.1 Control codes

NUL (00 Hex)

Used with ESC D and ESC B as a list terminator.

BEL (07 Hex)

·Sounds the printer audio alarm.

BS (08 Hex)

- Backspace with buffer flush.
- Causes any characters in the print buffer to be printed and then sets the next print position to be one character to the left of the current print position.
- BS can be used in this way to overstrike previously printed characters.
- Backspace beyond the leftmost position is not permitted.

HT (09 Hex)

- Horizontal tab to next tab stop set by ESC D.
- When HT code is received, the print position is skipped to the predetermined tab position by ESC D code.
- A tab stop is set every 8 columns when powered on.

LF (0A Hex)

- Line feed with buffer flush.
- Prints out current buffer contents and feeds the paper one line. Subsequent data will be printed from the column next to the last column on the previous line.
- The amount of line spacing is set by ESC 0, ESC 1, ESC 2, ESC 3, or ESC A.

VT (0B Hex)

- Spaces the paper to the next vertical tab stop position after printing the current buffer contents.
- If no tab stop position have been defined, VT is treated as LF.

CR (0D Hex)

- Carriage return with buffer flush.
- Prints out current buffer contents, and moves the printing position to the leftmost position of platen.

SO (0E Hex)

- Double width mode on to end of line.
- In this mode, the width of a printed character is elongated to twice its normal width.
- 10CPI, 12CPI and 17.1CPI characters can ne elongated.
- This mode is able to combine with Emphasized or Underlined.
- This mode is terminated by DC4, ESC W 0 or ESC !.

SI (0F Hex)

- Compressed width mode on .
- In this mode, dot pitch is compressed in 17.1 CPI.
- This mode is not emphasized.
- This mode is terminated by one of the followings:
 - 1) Compressed off(DC 2) Command
 - 2) CR, LF, VT or other buffer flush code
 - 3) Printer initialization
 - 4) 10 CPI or 12 CPI select command.

DC 1 (11 Hex)

- Printer Select
- Changes the printer to accept data from the computer.

★ DC 2 (12 Hex)

- Compressed width mode off with buffer flush.
- Cancel compressed mode and enters 10 CPI print mode.

Example:

- 17.1 CPI → DC2 → 10CPI
- 8.55 CPI → DC2 → 5CPI
- 17.1 CPI script → DC2 → 10CPI Script

DC 3 (13 Hex)

- Printer deselect
- In deselect status printer does not accept data from the computer.
- The printer returns to select status by DC 1 code.

DC 4 (14 Hex)

- Terminates the Double width print mode which is set by SO.

CAN (18 Hex)

- Clear print buffer
- The data in the print buffer which have been entered before CAN are cleared without printing.
- All commands which may have been included in the print buffer remain in effect.

★ ESC SP (1B 20 Hex)

Ignore spaces until a valid escape sequence qualifier or a non space character is received.

★ ESC ! n (1B 2lnHex)

• Select print mode n.

bit	7	6	5	4	3	2	1	0
1	UL		D		E	C		12CPI
0								10CPI
	2^7	2^6	2^5	2^4	2^3	2^2	2^1	2^0

D:Double width
E:Emphasized
C:Compressed
UL:Underline

- According to the value of n, the combination of print mode is selected.
- 12CPI print pitch selected by this code is not combined with Emphasized nor compressed.
- Print modes are combined as shown in Table I 3.
- Each print mode is cancelled by receiving the cancel code of each print mode.
- The print mode selected by ESC! code are terminated if the cancel codes of each print mode or print pitch are received.

Example

• Double width mode of 12CPI is selected, when

$$n = 2^5 \times 1 + 2^0 \times 1 = 33$$

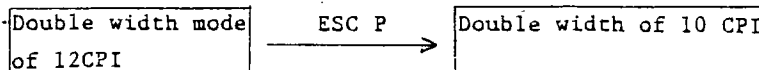

ESC 9 (1B 39 Hex)
·Enable paper out detect.
·ESC 9 is selected when the printer is powered on or reset.

ESC < (1B 3C Hex)
·Unidirectional print for one line.
·This command is treated as CR(0D Hex)

ESC @ (1B 40 Hex)
·Software reset
·The contents of the print buffer are cancelled.
·The print pitch is set to 10CPI.
·The attributes of underline, emphasized, super/subscript and double width are cancelled.
·The horizontal tab is set to its power-on condition, that is, a tab position is set every eight column.
·The vertical tab position is reset.
·The line feed pitch is set to 1/6".
·Both the left margin and the right margin are cleared.
·National character set selection and color selection are set to power on condition.

ESC A n (1B 41 n Hex)
·Sets $n/72$ " line feed spacing.
·n is a decimal number, $0 \leq n \leq 85$.

ESC B n_1 --- n_k NUL (1B 42 n_1 --- n_k 00 Hex)
·Set vertical tabs
·This sequence clears all previously set tab stops and causes the Printer to accept the following codes as vertical tab stop line numbers until NUL is received.
· $n_k < n_{k+1}$, $K_{max} = 16$
· $1 \leq n \leq 255$

- If tab stops are not entered in ascending order, vertical tab setting should be terminated.
- k should not exceed 16.
- If the printer is reset by ESC @, powered OFF or in case of paper end, tab stops are cleared.
- ESC B code followed by NUL only cancels predefined tab stops and the VT code behaves as a LF code.
- n is counted from the 1st printed line on the paper.

ESC D n_1 --- n_k NUL (1B 44 n_1 --- n_k 00 Hex)

- Set horizontal tabs.
- This sequence clears all previously set tab stops and causes the printer to accept the following codes as horizontal tab stop column numbers until NUL is received.
- $n_k < n_{k+1}$, $K_{max} = 32$
- If tab stops are not entered in ascending order, or if the numbers of tabs is more than 32, horizontal tab setting should be terminated.
- $1 < n < n_{max}$, n_{max} is the maximum number of characters per line for a print pitch.
- If the n is bigger than n_{max} , horizontal tab setting should be terminated.
- If the printer is powered ON, a tab stop is set every 8 columns.
- The HT code is used to execute a tab operation.
- If the Printer is reset by ESC @, predefined tab stops are cancelled and a tab stop is set every 8 columns.
- If ESC D code is followed by only NUL code, predefined tab stops are cancelled and no tab stop is setting.

ESC E (1B 45 Hex)

- Emphasized mode on.
- Subsequent characters are entered into emphasized print mode.
- Compressed mode characters are not emphasized.

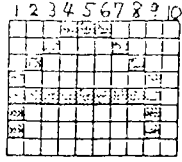

Normal character.

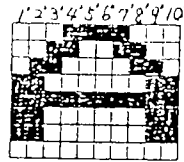

Bold character

- 1'=1
- 2'=1 or 2
- 3'=2 or 3
- 4'=3 or 4
-
-
- 9'=8 or 9
- 10'=9 or 10

ESC F (1B 46 Hex)

- Cancels emphasized printing.

ESC J n (1B 4A n Hex)

- n/144" line spacing with buffer flush.
- When ESC J is received, the contents of print buffer are printed and a paper feed of n/144" is executed.
- 0 ≤ n ≤ 255.

ESC H (1B 48 Hex)

- Superscript / Subscript modes off.
- This code is treated as ESC T.

ESC M (1B 4D Hex)

- Elite pitch (12CPI) mode on.
- This code sets the print pitch to 12 CPI.
- Super/subscript will not be cancelled.

ESC P (1B 50 Hex)

- Pica pitch (10 CPI) mode on.
- This code sets the print pitch to 10CPI.
- Super/subscript will not be cancelled.
- This mode is a default setting.

ESC Q n (1B 51 n Hex)

- Set right margin to n character columns.
- 1-n-n_{max}, n_{max} is the maximum number of characters per line for a print pitch.
- If n=0, this code will be ignored.

- Right margin is held as an Absolute Position on the line, Subsequent changes of the character pitch will not alter its physical position.
- In bit image graphic mode, data larger than the right margin are cancelled.

ESC R n (1B 52 n Hex)

- Select national character set n.
- n defines the characters of a particular country as follows:

n	country
0	United Kingdom
1	United States
2	Finland
3	Norway/Denmark
4	Sweden
5	Japan Roman
6	Japan katakana
7	Germany
8	French canada
9	France
10	Italy
11	Spain
- The national character set is illustrated in Appendix.
- When the printer is powered on, USA is selected.

ESC S n (1B 53 n Hex)

- Super/Subscript mode select depending on n.
- If n=0, the printer will print subsequent characters in superscript mode where the characters occupy the upper half of a normal character position.
- If n=1, the printer will print subsequent characters in subscript mode where characters occupy the lower half of a

normal character position.

ESC T (1B 54 Hex)

- Super/subscript mode off.
- This code cancels superscript or subscript mode.
- It is not necessary to cancel subscript in order to enter superscript and vice-versa.

ESC W n (1B 57 Hex)

- Double width mode on or off depending on n.
- When n=1, ESC W will change the printer to the Double Width print mode.
- This mode is not cancelled by a line feed operation.
- This mode is cancelled by ESC W 0 and is not cancelled by DC 4.
- ESC W 0 also cancels the Double Width mode entered by SO code.

ESC X n (1B 58 n Hex)

- Set color depending on n.
- Receiving the sequence of ESC X n, the printer will be set to color print mode.
- If n is bigger than 8, this command is ignored and previous color mode remains.
- When the power is switched on, black is defined as the default setting.

n	color
0	black
1	blue
2	green
3	cyan
4	red
5	magenta
6	yellow
7	white

Delete last character in buffer.

ESC K n1 n2 v1v2 -----vk (1B 4B Hex)

- Select 60DPI Bit image.
- The number of bit image data Bytes per one line (k) is equal to $n_1 + 256n_2$, and cannot exceed 480 Bytes.
- v1-----vk are the Bytes of the bit image data.
- The patterns are printed with the top eight dots of the print head and MSB of the pattern correspond to the highest dot:

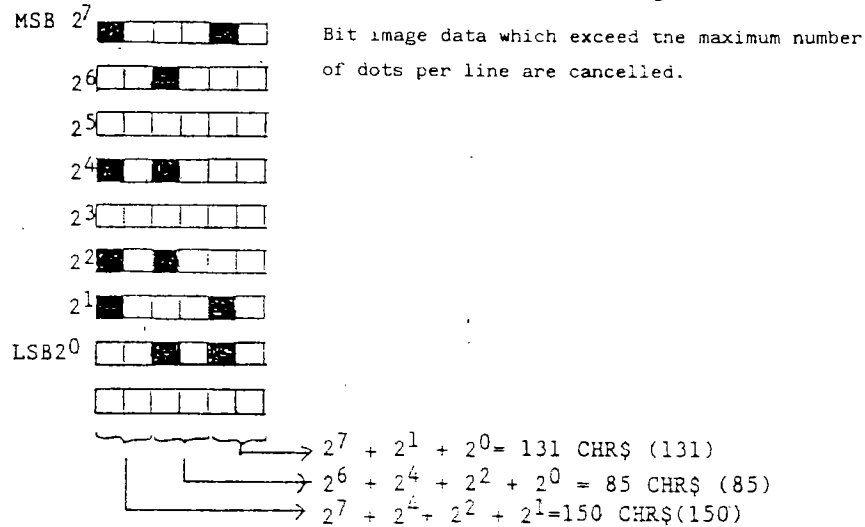

ESC L n1 n2 v1 v2 -----vk (1B 4C n1 n2 v1v2 -----vk Hex)

- Select 120DPI Bit Image
- The number of bit image data bytes (K) is equal to $n_1 + 256n_2$ and cannot exceed 960 bytes.
- If the number would exceed 960 bytes the excess patterns are ignored and not printed.
- v1-----vk are the bytes to be sent to printer.
- The patterns are printed with the top eight dots of the print head and MSB of the patterns correspond to the highest dot.

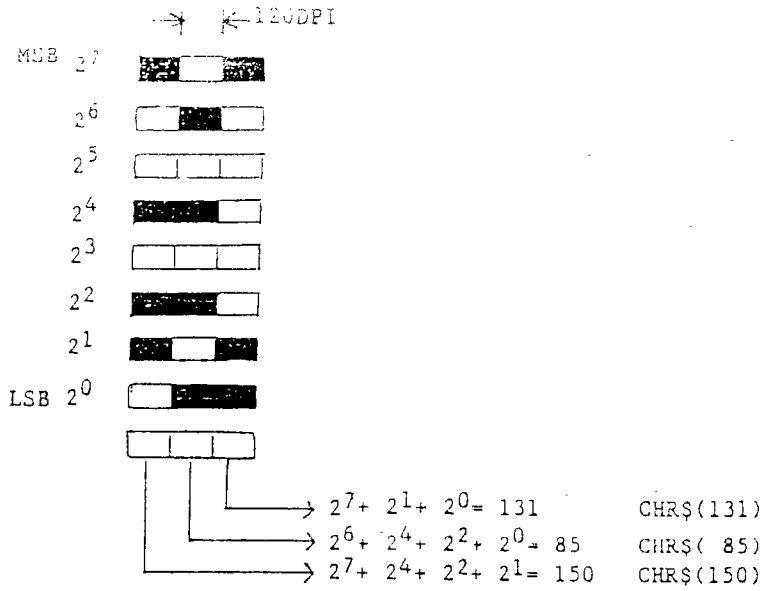

ESC Y n₁ n₂ v₁ v₂-----v_k (1B 59 n₁ n₂ v₁v₂-----v_k Hex)

- Select 160 DPI Bit Image
- The number of bit image data bytes (K), is equal to n₁+256n₂ and cannot exceed 1280 bytes.
- If the number would exceed 1280 bytes the excess patterns are ignored and not printed.
- v₁-----v_k are the bytes to be sent to printer.
- The patterns are printed with the top eight dots of the print head and MSB of the patterns correspond to the highest dot.

ESC ^ n n1 n2 v1 v2 ... vk (1B 5E n n1 n2 v1 v2 ... vk Hex)

BitMap 9 bit mode depending on n.

n=0 480 BitMap mode

n=1 960 BitMap mode

n=2 Ignored

n=3 1280 BitMap mode

len= n1 + n2*256

The patterns are printed with nine dots of the print head and MSB of patterns correspond to the highest dot.

ESC 1 n (1B 6C Hex)

Left margin set

When this code is sent, the printer will change the left margin.

n indicates the number of characters counted by the current font pitch from the leftmost position.

Once the left margin is set, this margin will not be changed even when the character mode is changed.

The maximum value of n is limited to the maximum printable characters in the current printing mode minus 2. Otherwise, this command will be ignored.

If ESC 1 code is sent at the beginning of the line, left margin will be set from that line. If ESC 1 code is sent in the middle of the line, left margin will be set from the next line.

ESC 1 clears the horizontal tab settings.

When the left margin set is changed, the new left margin becomes the start position of the horizontal tab.

... Print Mode

PI = Pica
EL = Elite
CW = compressed width
BO = emphasized
DW = double width
UL = under line
SS = super/ sub script

	PI	EL	CW	BO	DW	UL	SS
PI		(a)	yes	yes	yes	yes	yes
EL	(a)		yes	(b)	yes	yes	yes
CW	yes	yes		(c)	yes	yes	yes
BO	yes	(b)	(c)		yes	yes	(d)
DW	yes	yes	yes	yes		yes	(e)
UL	yes	yes	yes	yes	yes		yes
SS	yes	yes	yes	(d)	(e)	yes	

- (a) impossible combination
- (b) elite has precedence over emphasized until canceled.
- (c) emphasized has precedence over compressed until canceled.
- (d) emphasized has precedence over super/ sub script until canceled.
- (e) double width has precedence over super/ sub script until canceled.

1.3

DIP Switch setting (Atari /IBM)

No	Function	OFF	CN	Factory Setting
1	Mode	Atari	IBM	OFF
2				
3				
4				
5	Character set	Set 2	Set 1	OFF
6	Line Spacing	1/6"	1/8"	OFF
7	Bell	No Bell	Bell	CN
8	CR	CR Only	CR+LF	OFF

No 5 and 6 are valid only in IBM mode.

1.4 Character table

0 == United Kingdom

0 1 2 3 4 5 6 7		0 1 2 3 4 5 6 7		0 1 2 3 4 5 6 7																						
SP	0	1	2	3	4	5	6	7	SP	0	1	2	3	4	5	6	7	SP	0	1	2	3	4	5	6	7
	32	33	34	35	36	37	38	39		40	41	42	43	44	45	46	47		48	49	50	51	52	53	54	55
	64	65	66	67	68	69	70	71		72	73	74	75	76	77	78	79		80	81	82	83	84	85	86	87
	96	97	98	99	100	101	102	103		104	105	106	107	108	109	110	111		112	113	114	115	116	117	118	119
	128	129	130	131	132	133	134	135		136	137	138	139	140	141	142	143		144	145	146	147	148	149	150	151
	160	161	162	163	164	165	166	167		168	169	170	171	172	173	174	175		176	177	178	179	180	181	182	183
	192	193	194	195	196	197	198	199		200	201	202	203	204	205	206	207		208	209	210	211	212	213	214	215
	224	225	226	227	228	229	230	231		232	233	234	235	236	237	238	239		240	241	242	243	244	245	246	247
	256	257	258	259	260	261	262	263		264	265	266	267	268	269	270	271		272	273	274	275	276	277	278	279
	288	289	290	291	292	293	294	295		296	297	298	299	300	301	302	303		304	305	306	307	308	309	310	311
	320	321	322	323	324	325	326	327		328	329	330	331	332	333	334	335		336	337	338	339	340	341	342	343
	352	353	354	355	356	357	358	359		360	361	362	363	364	365	366	367		368	369	370	371	372	373	374	375
	384	385	386	387	388	389	390	391		392	393	394	395	396	397	398	399		400	401	402	403	404	405	406	407
	416	417	418	419	420	421	422	423		424	425	426	427	428	429	430	431		432	433	434	435	436	437	438	439
	448	449	450	451	452	453	454	455		456	457	458	459	460	461	462	463		464	465	466	467	468	469	470	471
	480	481	482	483	484	485	486	487		488	489	490	491	492	493	494	495		496	497	498	499	500	501	502	503
	512	513	514	515	516	517	518	519		520	521	522	523	524	525	526	527		528	529	530	531	532	533	534	535
	544	545	546	547	548	549	550	551		552	553	554	555	556	557	558	559		560	561	562	563	564	565	566	567
	576	577	578	579	580	581	582	583		584	585	586	587	588	589	590	591		592	593	594	595	596	597	598	599
	608	609	610	611	612	613	614	615		616	617	618	619	620	621	622	623		624	625	626	627	628	629	630	631
	640	641	642	643	644	645	646	647		648	649	650	651	652	653	654	655		656	657	658	659	660	661	662	663
	672	673	674	675	676	677	678	679		680	681	682	683	684	685	686	687		688	689	690	691	692	693	694	695
	704	705	706	707	708	709	710	711		712	713	714	715	716	717	718	719		720	721	722	723	724	725	726	727
	736	737	738	739	740	741	742	743		744	745	746	747	748	749	750	751		752	753	754	755	756	757	758	759
	768	769	770	771	772	773	774	775		776	777	778	779	780	781	782	783		784	785	786	787	788	789	790	791
	800	801	802	803	804	805	806	807		808	809	810	811	812	813	814	815		816	817	818	819	820	821	822	823
	832	833	834	835	836	837	838	839		840	841	842	843	844	845	846	847		848	849	850	851	852	853	854	855
	864	865	866	867	868	869	870	871		872	873	874	875	876	877	878	879		880	881	882	883	884	885	886	887
	896	897	898	899	900	901	902	903		904	905	906	907	908	909	910	911		912	913	914	915	916	917	918	919
	928	929	930	931	932	933	934	935		936	937	938	939	940	941	942	943		944	945	946	947	948	949	950	951
	960	961	962	963	964	965	966	967		968	969	970	971	972	973	974	975		976	977	978	979	980	981	982	983
	992	993	994	995	996	997	998	999		1000	1001	1002	1003	1004	1005	1006	1007		1008	1009	1010	1011	1012	1013	1014	1015

INDICATES DIFFERENCES FROM ASCII

1 == United States

0 1 2 3 4 5 6 7		0 1 2 3 4 5 6 7		0 1 2 3 4 5 6 7																						
SP	0	1	2	3	4	5	6	7	SP	0	1	2	3	4	5	6	7	SP	0	1	2	3	4	5	6	7
	32	33	34	35	36	37	38	39		40	41	42	43	44	45	46	47		48	49	50	51	52	53	54	55
	64	65	66	67	68	69	70	71		72	73	74	75	76	77	78	79		80	81	82	83	84	85	86	87
	96	97	98	99	100	101	102	103		104	105	106	107	108	109	110	111		112	113	114	115	116	117	118	119
	128	129	130	131	132	133	134	135		136	137	138	139	140	141	142	143		144	145	146	147	148	149	150	151
	160	161	162	163	164	165	166	167		168	169	170	171	172	173	174	175		176	177	178	179	180	181	182	183
	192	193	194	195	196	197	198	199		200	201	202	203	204	205	206	207		208	209	210	211	212	213	214	215
	224	225	226	227	228	229	230	231		232	233	234	235	236	237	238	239		240	241	242	243	244	245	246	247
	256	257	258	259	260	261	262	263		264	265	266	267	268	269	270	271		272	273	274	275	276	277	278	279
	288	289	290	291	292	293	294	295		296	297	298	299	300	301	302	303		304	305	306	307	308	309	310	311
	320	321	322	323	324	325	326	327		328	329	330	331	332	333	334	335		336	337	338	339	340	341	342	343
	352	353	354	355	356	357	358	359		360	361	362	363	364	365	366	367		368	369	370	371	372	373	374	375
	384	385	386	387	388	389	390	391		392	393	394	395	396	397	398	399		400	401	402	403	404	405	406	407
	416	417	418	419	420	421	422	423		424	425	426	427	428	429	430	431		432	433	434	435	436	437	438	439
	448	449	450	451	452	453	454	455		456	457	458	459	460	461	462	463		464	465	466	467	468	469	470	471
	480	481	482	483	484	485	486	487		488	489	490	491	492	493	494	495		496	497	498	499	500	501	502	503
	512	513	514	515	516	517	518	519		520	521	522	523	524	525	526	527		528	529	530	531	532	533	534	535
	544	545	546	547	548	549	550	551		552	553	554	555	556	557	558	559		560	561	562	563	564	565	566	567
	576	577	578	579	580	581	582	583		584	585	586	587	588	589	590	591		592	593	594	595	596	597	598	599
	608	609	610	611	612	613	614	615		616	617	618	619	620	621	622	623		624	625	626	627	628	629	630	631
	640	641	642	643	644	645	646	647		648	649	650	651	652	653	654	655		656	657	658	659	660	661	662	663
	672	673	674	675	676	677	678	679		680	681	682	683	684	685	686	687		688	689	690	691	692	693	694	695
	704	705	706	707	708	709	710	711		712	713	714	715	716	717	718	719		720	721	722	723	724	725	726	727
	736	737	738	739	740	741	742	743		744	745	746	747	748	749	750	751		752	753	754	755	756	757	758	759
	768	769	770	771	772	773	774	775		776	777	778	779	780	781	782	783									

3 == Norway / Denmark

0 1 1 1		0 1 1 1		0 1 1 1		0 1 1 1		0 1 1 1		0 1 1 1	
2	3	4	5	6	7	2	3	4	5	6	7
SP	0	X	P	A	P	146	147	148	149	150	151
I	1	A	Q	B	Q	152	153	154	155	156	157
II	2	B	II	b	r	158	159	160	161	162	163
#	3	C	S	c	8	164	165	166	167	168	169
\$	4	D	T	d	i	170	171	172	173	174	175
%	5	E	U	e	U	176	177	178	179	180	181
&	6	F	V	f	v	182	183	184	185	186	187
'	7	G	W	g	w	188	189	190	191	192	193
(8	H	X	h	x	194	195	196	197	198	199
)	9	I	Y	i	y	200	201	202	203	204	205
*	:	J	Z	j	z	206	207	208	209	210	211
+	;	K	E	k	8	212	213	214	215	216	217
,	<	L	D	l	8	218	219	220	221	222	223
-	=	M	A	m	8	224	225	226	227	228	229
.	>	N	U	n	8	230	231	232	233	234	235
/	?	O	-	o	8	236	237	238	239	240	241
						242	243	244	245	246	247
						248	249	250	251	252	253
						254	255	256	257	258	259
						260	261	262	263	264	265
						266	267	268	269	270	271
						272	273	274	275	276	277
						278	279	280	281	282	283
						284	285	286	287	288	289
						290	291	292	293	294	295
						296	297	298	299	300	301
						302	303	304	305	306	307
						308	309	310	311	312	313
						314	315	316	317	318	319
						320	321	322	323	324	325
						326	327	328	329	330	331
						332	333	334	335	336	337
						338	339	340	341	342	343
						344	345	346	347	348	349
						350	351	352	353	354	355
						356	357	358	359	360	361
						362	363	364	365	366	367
						368	369	370	371	372	373
						374	375	376	377	378	379
						380	381	382	383	384	385
						386	387	388	389	390	391
						392	393	394	395	396	397
						398	399	400	401	402	403
						404	405	406	407	408	409
						410	411	412	413	414	415
						416	417	418	419	420	421
						422	423	424	425	426	427
						428	429	430	431	432	433
						434	435	436	437	438	439
						440	441	442	443	444	445
						446	447	448	449	450	451
						452	453	454	455	456	457
						458	459	460	461	462	463
						464	465	466	467	468	469
						470	471	472	473	474	475
						476	477	478	479	480	481
						482	483	484	485	486	487
						488	489	490	491	492	493
						494	495	496	497	498	499
						500	501	502	503	504	505
						506	507	508	509	510	511
						512	513	514	515	516	517
						518	519	520	521	522	523
						524	525	526	527	528	529
						530	531	532	533	534	535
						536	537	538	539	540	541
						542	543	544	545	546	547
						548	549	550	551	552	553
						554	555	556	557	558	559
						560	561	562	563	564	565
						566	567	568	569	570	571
						572	573	574	575	576	577
						578	579	580	581	582	583
						584	585	586	587	588	589
						590	591	592	593	594	595
						596	597	598	599	600	601
						602	603	604	605	606	607
						608	609	610	611	612	613
						614	615	616	617	618	619
						620	621	622	623	624	625
						626	627	628	629	630	631
						632	633	634	635	636	637
						638	639	640	641	642	643
						644	645	646	647	648	649
						650	651	652	653	654	655
						656	657	658	659	660	661
						662	663	664	665	666	667
						668	669	670	671	672	673
						674	675	676	677	678	679
						680	681	682	683	684	685
						686	687	688	689	690	691
						692	693	694	695	696	697
						698	699	700	701	702	703
						704	705	706	707	708	709
						710	711	712	713	714	715
						716	717	718	719	720	721
						722	723	724	725	726	727
						728	729	730	731	732	733
						734	735	736	737	738	739
						740	741	742	743	744	745
						746	747	748	749	750	751
						752	753	754	755	756	757
						758	759	760	761	762	763
						764	765	766	767	768	769
						770	771	772	773	774	775
						776	777	778	779	780	781
						782	783	784	785	786	787
						788	789	790	791	792	793
						794	795	796	797	798	799
						800	801	802	803	804	805
						806	807	808	809	810	811
						812	813	814	815	816	817
						818	819	820	821	822	823
						824	825	826	827	828	829
						830	831	832	833	834	835
						836	837	838	839	840	841
						842	843	844	845	846	847
						848	849	850	851	852	853
						854	855	856	857	858	859
						860	861	862	863	864	865
						866	867	868	869	870	871
						872	873	874	875	876	877
						878	879	880	881	882	883
						884	885	886	887	888	889
						890	891	892	893	894	895
						896	897	898	899	900	901
						902	903	904	905	906	907
						908	909	910	911	912	913
						914	915	916	917	918	919
						920	921	922	923	924	925
						926	927	928	929	930	931
						932	933				

6 == Japan Katakana

0 1 0		0 1 1		1 0 0		1 0 1		1 1 0		1 1 1	
2	3	4	5	6	7	2	3	4	5	6	7
SP	ー	ク	ニ	シ	フ	SP	0	A	P	0	P
・	フ	チ	ハ	フ	フ	1	1	A	Q	1	Q
「	ツ	ツ	ク	フ	フ	2	2	B	R	2	R
」	テ	テ	ク	フ	フ	3	3	C	S	3	S
、	ト	ト	ク	フ	フ	4	4	D	T	4	T
・	ナ	ナ	ク	フ	フ	5	5	E	U	5	U
ヲ	ニ	ニ	ク	フ	フ	6	6	F	V	6	V
イ	ヌ	ヌ	ク	フ	フ	7	7	G	W	7	W
フ	ネ	ネ	ク	フ	フ	8	8	H	X	8	X
ク	ノ	ノ	ク	フ	フ	9	9	I	Y	9	Y
ケ	ハ	ハ	ク	フ	フ	0	0	B	X	0	X
コ	ヒ	ヒ	ク	フ	フ	1	1	0	Y	1	Y
サ	ロ	ロ	ク	フ	フ	2	2	1	Z	2	Z
シ	ワ	ワ	ク	フ	フ	3	3	2	A	3	A
ス	ホ	ホ	ク	フ	フ	4	4	3	O	4	O
セ	マ	マ	ク	フ	フ	5	5	4	U	5	U
ソ	マ	マ	ク	フ	フ	6	6	5	1	6	1
			ク	フ	フ	7	7	6	2	7	2
			ク	フ	フ	DEL	DEL	7	3	DEL	3
			ク	フ	フ				4		4
			ク	フ	フ				5		5
			ク	フ	フ				6		6
			ク	フ	フ				7		7
			ク	フ	フ				8		8
			ク	フ	フ				9		9
			ク	フ	フ				0		0
			ク	フ	フ				1		1
			ク	フ	フ				2		2
			ク	フ	フ				3		3
			ク	フ	フ				4		4
			ク	フ	フ				5		5
			ク	フ	フ				6		6
			ク	フ	フ				7		7
			ク	フ	フ				8		8
			ク	フ	フ				9		9
			ク	フ	フ				0		0
			ク	フ	フ				1		1
			ク	フ	フ				2		2
			ク	フ	フ				3		3
			ク	フ	フ				4		4
			ク	フ	フ				5		5
			ク	フ	フ				6		6
			ク	フ	フ				7		7
			ク	フ	フ				8		8
			ク	フ	フ				9		9
			ク	フ	フ				0		0
			ク	フ	フ				1		1
			ク	フ	フ				2		2
			ク	フ	フ				3		3
			ク	フ	フ				4		4
			ク	フ	フ				5		5
			ク	フ	フ				6		6
			ク	フ	フ				7		7
			ク	フ	フ				8		8
			ク	フ	フ				9		9
			ク	フ	フ				0		0
			ク	フ	フ				1		1
			ク	フ	フ				2		2
			ク	フ	フ				3		3
			ク	フ	フ				4		4
			ク	フ	フ				5		5
			ク	フ	フ				6		6
			ク	フ	フ				7		7
			ク	フ	フ				8		8
			ク	フ	フ				9		9
			ク	フ	フ				0		0
			ク	フ	フ				1		1
			ク	フ	フ				2		2
			ク	フ	フ				3		3
			ク	フ	フ				4		4
			ク	フ	フ				5		5
			ク	フ	フ				6		6
			ク	フ	フ				7		7
			ク	フ	フ				8		8
			ク	フ	フ				9		9
			ク	フ	フ				0		0
			ク	フ	フ				1		1
			ク	フ	フ				2		2
			ク	フ	フ				3		3
			ク	フ	フ				4		4
			ク	フ	フ				5		5
			ク	フ	フ				6		6
			ク	フ	フ				7		7
			ク	フ	フ				8		8
			ク	フ	フ				9		9
			ク	フ	フ				0		0
			ク	フ	フ				1		1
			ク	フ	フ				2		2
			ク	フ	フ				3		3
			ク	フ	フ				4		4
			ク	フ	フ				5		5
			ク	フ	フ				6		6
			ク	フ	フ				7		7
			ク	フ	フ				8		8
			ク	フ	フ				9		9
			ク	フ	フ				0		0
			ク	フ	フ				1		1
			ク	フ	フ				2		2
			ク	フ	フ				3		3
			ク	フ	フ				4		4
			ク	フ	フ				5		5
			ク	フ	フ				6		6
			ク	フ	フ				7		7
			ク	フ	フ				8		8
			ク	フ	フ				9		9
			ク	フ	フ				0		0
			ク	フ	フ				1		1
			ク	フ	フ				2		2
			ク	フ	フ				3		3
			ク	フ	フ				4		4
			ク	フ	フ				5		5
			ク	フ	フ				6		6
			ク	フ	フ				7		7
			ク	フ	フ				8		8
			ク	フ	フ				9		9
			ク	フ	フ				0		0
			ク	フ	フ				1		1
			ク	フ	フ				2		2
			ク	フ	フ				3		3
			ク	フ	フ				4		4
			ク	フ	フ				5		5
			ク	フ	フ				6		6
			ク	フ	フ				7		7
			ク	フ	フ				8		8
			ク	フ	フ				9		9
			ク	フ	フ				0		0
			ク	フ	フ				1		1
			ク	フ	フ				2		2
			ク	フ	フ				3		3
			ク	フ	フ				4		4
			ク	フ	フ				5		5
			ク	フ	フ				6		6
			ク	フ	フ				7		7
			ク	フ	フ				8		8
			ク	フ	フ				9		9
			ク	フ	フ				0		0
			ク	フ	フ				1		1
			ク	フ	フ				2		2
			ク	フ	フ				3		3
			ク	フ	フ				4		4
			ク	フ	フ				5		5
			ク	フ	フ				6		6
			ク	フ	フ				7		7
			ク	フ	フ				8		8
			ク	フ	フ				9		9
			ク	フ	フ				0		0
			ク	フ	フ				1		1
			ク	フ	フ				2		2
			ク	フ	フ				3		3
			ク	フ	フ				4		4
			ク	フ	フ				5		5
			ク	フ	フ				6		6
			ク	フ	フ				7		7
			ク	フ	フ				8		8
			ク	フ</							

2. IBM

The 57C-504 printer enters into IBM mode by setting the DIP SW1 ON.

NUL	(00 Hex)	Same as Atari mode.
BEL	(07 Hex)	Same as Atari mode.
BS	(08 Hex)	Same as Atari mode.
HT	(09 Hex)	Same as Atari mode.
LF	(0A Hex)	<ul style="list-style-type: none">•Line feed with buffer flush.•Prints out current buffer contents and feeds the paper one line. Carriage return is performed after printing the buffer.•The amount of line spacing is set by ESC 0, ESC 1, ESC 2, ESC 3, or ESC A.
VT	(0B Hex)	Same as Atari mode.
CR	(0D Hex)	Same as Atari mode.
SO	(0E Hex)	Same as Atari mode.
SI	(0F Hex)	Same as Atari mode.
DC1	(11 Hex)	Same as Atari mode.
DC2	(12 Hex)	Same as Atari mode.
DC3	(13 Hex)	Same as Atari mode.
DC4	(14 Hex)	Same as Atari mode.
CAN	(18 Hex)	Same as Atari mode.

ESC SP (1B 20 Hex)
 Same as Atari mode.

ESC ! n (1B 21 n Hex)
 Same as Atari mode.

ESC - n (1B 2D n Hex)
 Same as Atari mode.

ESC 0 (1B 30 Hex)
 Same as Atari mode.

ESC 1 (1B 31 Hex)
 Same as Atari mode.

ESC 2 (1B 32 Hex)
 Same as Atari mode.

ESC 3 n (1B 33 n Hex)
 • Changes line feed length to n/216".
 • $1 \leq n \leq 255$.
 • n is a decimal number.

ESC 6 (1B 36 Hex)
 • Select IBM character set 2.

ESC 7 (1B 37 Hex)
 • Select IBM character set 1.
 • Character set 1 is selected when the printer is
 powered on or reset.

ESC 8 (1B 38 Hex)
 Same as Atari mode.

ESC 9 (1B 39 Hex)
 Same as Atari mode.

ESC < (1B 3C Hex)
 Same as Atari mode.

ESC 9 (1B 40 Hex)
 Same as Atari mode.

ESC A n (1B 41 n Hex)
 Same as Atari mode.

ESC B n₁ n₂ --- n_k NUL (1B 42 n₁ n₂ --- n_k 00 Hex)
 Same as Atari mode.

ESC D n₁ n₂ --- n_k NUL (1B 44 n₁ n₂ --- n_k 00 Hex)
 Same as Atari mode.

ESC E (1B 45 Hex)
 Same as Atari mode.

ESC F (1B 46 Hex)
 Same as Atari mode.

ESC H (1B 4J Hex)
 Same as Atari mode.

ESC J n (1B 4A Hex)
 • n/216" line spacing with buffer flush.
 • When ESC J is received, the contents of print
 buffer are printed and a paper feed of n/216"
 is executed.
 • $1 \leq n \leq 255$.

ESC K (1B 4B Hex)
 Same as Atari mode.

ESC L (1B 4C Hex)
 Same as Atari mode.

ESC M (1B 4D Hex)
 Same as Atari mode.

ESC P (1B 50 Hex)
 Same as Atari mode.

ESC Q n (1B 51 n Hex)
 Same as Atari mode.

ESC R n (1B 52 n Hex)
 Same as Atari mode.

ESC S n (1B 53 n Hex)
 Same as Atari mode.

ESC T (1B 54 Hex)
 Same as Atari mode.

ESC W n (1B 57 Hex)
 Same as Atari mode.

ESC Y n₁ n₂ v₁ v₂ --- v_k (1B 59 n₁ n₂ v₁ v₂ --- v_k Hex)
 • Same as ESC L.
 • Select 120 DPI Bit Image.

ESC ^ n₁ n₂ v₁ --- v_k (1B 5E n₁ n₂ v₁ --- v_k Hex)
 • BitMap 9 bit mode depending on n.
 n=0 480 BitMap mode
 n=1 960 BitMap mode
 • len= n₁ + n₂ * 256
 • The patterns are printed with nine dots of the
 print head and MSB of patterns correspond to the
 highest dot.

ESC l n (1B 6C Hex)
Same as Atari mode.











ESC r n (1B 72 n Hex)
·Set color printing depending on n.
·When the power is switched on, black is defined
as the default setting.

n	color
0	black
1	magenta
2	cyan
3	blue
4	yellow
5	red
6	green

DEL (7f Hex)
Same as Atari mode.

- NOTE 1) If screendump is executed under color print mode,
there will be a possibility that the computer
indicates "Device Time Out Error".
- 2) If color printing which includes text printing and
graphic printing is executed under the IBM-PC
built-in ROM Basic mode, there will be a possibility
that the computer indicates "Device Time Out Error".

2.3
IBM Graphics Set G1

	0	1	2	3	4	5	6	7	8	9	A	B	C	D	E	F
0	NUL		SP	0	@	P		p			á		L	┐	á	≡
1		DC1	!	1	A	Q	a	q		DC1	í		┐	┐	β	≡
2		DC2	"	2	B	R	b	r		DC2	ó		┐	┐	Γ	≡
3		DC3	#	3	C	S	c	s		DC3	ú		┐	┐	π	≡
4		DC4	\$	4	D	T	d	t		DC4	ñ	┐	┐	L	Σ	
5			%	5	E	U	e	u			Ñ	┐	┐	┐	σ	
6			&	6	F	V	f	v			ã	┐	┐	┐	μ	+
7	BEL			7	G	W	g	w	BEL		ø	┐	┐	┐	γ	≈
8	BS	CAN	(8	H	X	h	x	BS	CAN	¿	┐	┐	┐	Φ	°
9	HT)	9	I	Y	i	y	HT		┐	┐	┐	┐	θ	■
A	LF		.	:	J	Z	j	z	LF		┐	┐	┐	┐	Ω	-
B	VT	ESC	+	,	K	[k	{	VT	ESC	½	┐	┐		δ	√
C			.	<	L	\	l				¼	┐	┐		∞	•
D	CR		-	=	M]	m	}	CR		i	┐	┐		∅	?
E	SO		.	>	N	^	n	~	SO		<<	┐	┐		ε	■
F	SI		/	?	O	_	o		SI		>>	┐	┐		∩	SP

IBM Graphics Set G2

	0	1	2	3	4	5	6	7	8	9	A	B	C	D	E	F
0	NUL		SP	0	@	P		p	ç	É	á		L	⊥	α	≡
1		DC1		1	A	Q	a	q	ú	æ	í		⊥	⊥	β	≠
2		DC2	"	2	B	R	b	r	é	Æ	ó		⊥	⊥	Γ	≧
3	♥	DC3	#	3	C	S	c	s	à	ò	ú		⊥	⊥	π	≡
4	♦	DC4	\$	4	D	T	d	t	á	ó	ñ	-	-	⊥	Σ	↵
5	♣	§	%	5	E	U	e	u	à	ò	Ñ	-	⊥	⊥	σ	↵
6	♠		&	6	F	V	f	v	á	ú	á	⊥	⊥		μ	+
7	BEL			7	G	W	g	w	ç	ù	ø	⊥	⊥	⊥	γ	≡
8	BS	CAN	(8	H	X	h	x	è	ÿ	¿	⊥	⊥	⊥	φ	°
9	HT)	9	I	Y	i	y	ë	ó	⊥	⊥	⊥	⊥	θ	■
A	LF		.	:	J	Z	j	z	è	ü	⊥	⊥	⊥	⊥	Ω	-
B	VT	ESC	+	:	K	[k	(ī	φ	½	⊥	⊥		δ	↵
C			.	<	L	\	l		ī	£	¼	⊥	⊥		∞	•
D	CR		-	=	M]	m)	ı	¥	ı	⊥	-		ø	z
E	SO		.	>	N	^	n	~	Ä	Pt	<<	⊥	⊥	⊥	ε	■
F	SI		/	?	O	_	o		Ä	f	>>	⊥	⊥		∩	SP

3. Commodore

3.1 Control Code Table

Code	Hex	Function
BS	08	Begin dot-programmable graphic mode.
LF	0A	New Line.
CR	0D	New Line.
SO	0E	Begin 5CPI character mode.
SI	0F	End 5CPI character mode, begin 10CPI character mode.
POS	10	Tab to position in next 2 characters.
DC1	11	Switch to upper case/lower case character set.
DC2	12	Begin reverse character mode.
	14 n	Select color according n value. n=0 black, n=1 white, n=2 red, n=3 cyan, n=4 purple, n=5 green, n=6 blue, n=7 yellow
	1A	Repeat graphic data.
	1B	Move to specified dot position.
	81	Set to 10CPI.
	8D	Carriage return.
	91	Switch to upper case/graphic character set.
	13	Print command with no line feed.

3.2
COMMODORE DIP SWITCHES SETTING

Switch No.	Function	OFF	ON	Factory Setting
1		Device No.4	Device No.5	OFF
2		Graphics	Lower case	OFF
3				
4				

3.3 Commodore character set

Upper case/ lower case

	2	3	4	5	6	7	8	9	A	B	C	D	E	F
0	0	@	P	`	p									
1	!	1	A	Q	a	q								
2	"	2	B	R	b	r								
3	#	3	C	S	c	s								
4	\$	4	D	T	d	t								
5	%	5	E	U	e	u								
6	&	6	F	V	f	v								
7	'	7	G	W	g	w								
8	(8	H	X	h	x								
9)	9	I	Y	i	y								
A	*	:	J	Z	j	z								
B	+	;	K	[k	[
C	,	<	L]	l]								
D	-	=	M	^	m	^								
E	.	>	N	_	n	_								
F	/	?	O	~	o	~								

Upper case/ graphic

	2	3	4	5	6	7	8	9	A	B	C	D	E	F
0	0	@	P						π				π	
1	!	1	A	Q	◆	▲	◆	▲	◆	◆	▲	◆	◆	◆
2	"	2	B	R	◆	▲	◆	▲	◆	◆	▲	◆	◆	◆
3	#	3	C	S		·		·	◆	◆	◆	◆	◆	◆
4	\$	4	D	T	◆	▲	◆	▲	◆	◆	◆	◆	◆	◆
5	%	5	E	U	0				—	0				
6	&	6	F	V										
7	'	7	G	W					┌			┌		┌
8	(8	H	X	·	■	·	■	└		·	└		└
9)	9	I	Y	·	/	·	/	┌	▲	·	┌	▲	┌
A	*	:	J	Z	~	X	~	X	└	L	~	└	L	└
B	+	;	K	[~		~		+	◆	~	+	◆	+
C	,	<	L]	~		~		└	~	~	└	~	└
D	-	=	M	^	~	●	~	●	└		~	└		└
E	.	>	N	_	~		~		└		~	└		└
F	/	?	O	~	~		~		└	~	~	└	~	└

4. Apple

4.1 Control Code Table

Code	Hex	Function
ESC N	1F 4E	Set print pitch to 10CPI.
ESC E	1B 45	Set print pitch to 12CPI.
ESC Q	1B 51	Set print pitch to 17.1CPI.
ESC X	1B 58	Start underline text.
ESC Y	1B 59	Stop underline text.
ESC !	1B 21	Start emphasized printing.
ESC "	1B 22	End emphasized printing.
CONTROL-N	OE	Begin double width mode.
CONTROL-O	OF	End double width mode.
ESC A	1B 41	Set the line spacing to 1/6".
ESC B	1B 42	Set the line spacing to 1/8".
ESC T nn	1B 54 hh	Set the line spacing to n/144". (nn=01 to 99)
LF	OA	Forward line feeding.
CONTROL-__n	1F h	Feeds n lines of blank paper. (n=1,2,3,4,5,6,7,8,9,.,:;, <, =, >, ?)
CONTROL-H C	08	Backspace one character and prints the character C.
ESC O	1B 4F	Paper error detector off.
ESC o	1B 6F	Paper error detector on.
CONTROL-X	18	Clear all unprinted text.
ESC Z_CONTROL-@	1B 5A 20 0	No line feed at buffer-full printing. (__=space character. 20Hex.)
ESC D_CONTROL-@	1B 44 20 0	Line feed added at buffer-full printing. (__=space character. 20 Hex.)

Code	Hex	Function
ESC c	1B 63	Software reset.
ESC(a,b,---,n	1B 28 h ₁ ,h ₂ , ---	Set horizontal tab line.
ESC 0	1B 30	Clears all tabs.
CONTROL-1	09	Goes to next horizontal tab stop.
ESC G nnnn	1B 47 hhhh	Print graphic columns corresponding to the following nnnn data bytes.
ESC g nnn	1B 67 hhh	Print line corresponding to the following nnnx8 data bytes.
ESC K n	1B 48 h	Select color depending on n. n=1 (h=31) Yellow, n=2 (h=32) Magenta, n=3 (h=33) Cyan,
ESC L nnn	1B 4C hhh	Set left margin to character position nnn. (left most position=000)

4.2
Apple IIc DIP SWITCHES SETTING

Switch No.	Function	OFF	ON	Factory Setting
1		} International Character		OFF
2				OFF
3				OFF
4	Carriage Return	CR only	CR+LF	OFF
5	Print Pitch	10 CPI	17.1 CPI	OFF
6				
7		} Baud Rate		OFF
8				OFF

Apple IIc International Character

	Dip-Sw No.		
	1	2	3
U. S. A.	off	off	off
British	on	off	off
German	off	on	off
French	on	on	off
Swedish	off	off	on
Italian	on	off	on
Spanish	off	on	on
U. S. A.	on	on	on

Baud Rate

	Dip-Sw No.	
	7	8
300	on	on
1200	off	on
2400	on	off
9600	off	off

4.3 Character set table

ASCII	Dec	Hex	ASCII	Dec	Hex	ASCII	Dec	Hex
SP	32	\$ 20	②*	64	\$ 40	⑦*	96	\$ 60
!	33	\$ 21	A	65	\$ 41	a	97	\$ 61
"	34	\$ 22	B	66	\$ 42	b	98	\$ 62
③*	35	\$ 23	C	67	\$ 43	c	99	\$ 63
④*	36	\$ 24	D	68	\$ 44	d	100	\$ 64
%	37	\$ 25	E	69	\$ 45	e	101	\$ 65
&	38	\$ 26	F	70	\$ 46	f	102	\$ 66
'	39	\$ 27	G	71	\$ 47	g	103	\$ 67
(40	\$ 28	H	72	\$ 48	h	104	\$ 68
)	41	\$ 29	I	73	\$ 49	i	105	\$ 69
*	42	\$ 2A	J	74	\$ 4A	j	106	\$ 6A
+	43	\$ 2B	K	75	\$ 4B	k	107	\$ 6B
,	44	\$ 2C	L	76	\$ 4C	l	108	\$ 6C
-	45	\$ 2D	M	77	\$ 4D	m	109	\$ 6D
.	46	\$ 2E	N	78	\$ 4E	n	110	\$ 6E
/	47	\$ 2F	O	79	\$ 4F	o	111	\$ 6F
0	48	\$ 30	P	80	\$ 50	p	112	\$ 70
1	49	\$ 31	Q	81	\$ 51	q	113	\$ 71
2	50	\$ 32	R	82	\$ 52	r	114	\$ 72
3	51	\$ 33	S	83	\$ 53	s	115	\$ 73
4	52	\$ 34	T	84	\$ 54	t	116	\$ 74
5	53	\$ 35	U	85	\$ 55	u	117	\$ 75
6	54	\$ 36	V	86	\$ 56	v	118	\$ 76
7	55	\$ 37	W	87	\$ 57	w	119	\$ 77
8	56	\$ 38	X	88	\$ 58	x	120	\$ 78
9	57	\$ 39	Y	89	\$ 59	y	121	\$ 79
:	58	\$ 3A	Z	90	\$ 5A	z	122	\$ 7A
;	59	\$ 3B	③*	91	\$ 5B	⑧*	123	\$ 7B
! <	60	\$ 3C	④*	92	\$ 5C	⑨*	124	\$ 7C
>	61	\$ 3D	⑤*	93	\$ 5D	⑩*	125	\$ 7D
?	62	\$ 3E	⑥*	94	\$ 5E	⑪*	126	\$ 7E
	63	\$ 3F	-	95	\$ 5F	.	127	\$ 7F

Note: The reference symbol ①* refers to the character set below for National Languages.

(For National Languages)

Reference Number	0	1	2	3	4	5	6	7	8	9	10	11
Hexadecimal	\$ 23	\$ 24	\$ 40	\$ 5B	\$ 5C	\$ 5D	\$ 5E	\$ 60	\$ 7B	\$ 7C	\$ 7D	\$ 7E
American	£	£	£	£	£	£	£	£	£	£	£	£
British	£	£	£	£	£	£	£	£	£	£	£	£
German	£	£	£	£	£	£	£	£	£	£	£	£
French	£	£	£	£	£	£	£	£	£	£	£	£
Swedish	£	£	£	£	£	£	£	£	£	£	£	£
Italian	£	£	£	£	£	£	£	£	£	£	£	£
Spanish	£	£	£	£	£	£	£	£	£	£	£	£

(SMM 804)

No. 2 (2/36)

1985.5.20(Rev.11A)

1. Printer Specifications

- (1) Print Method: Serial Impact dot matrix
- (2) Print Speed: 80 CPS (typ.)
- (3) Print Direction: Bidirectional with logical seeking
- (4) Number of Pins in Head: 9
- (5) Line Spacing: 4.23 mm (1/6 inch) or programmable
- (6) Printing Characteristics
 - Matrix: 9 x 8 (Normal Characters) in 9 x 9 dot matrix field
 - Character Set: Full 96-character ASCII with descenders, Normal and italic alpha-numeric fonts, 36 International characters and 63 Japan Katakana DP1 Upper Set - 128
 - Bit Image mode: 8 x 480 dots/line bit image mode (normal density), 8 x 960 dots/line bit image mode, 8 x 1280 dots/line bit image mode and 9-pin bit image mode (9 x 480, 960 and 1280 dots/line)

(7) Printing Sizes

	Characters per inch	Maximum characters per line
Normal:	10	80
Enlarged:	5	40
Condensed:	17.77	142
Condensed Enlarged:	8.88	71
Subscript or Superscript:	10	80
Elite	12	96
Enlarged Elite	6	48

(8) Media Handling

- Paper Feed: Adjustable sprocket pin feed and friction feed.
- Paper Width Range: 101.6 mm (4 inches) to 254 mm (10 inches)
- Copies: One original plus one carbon copies, total thickness not to exceed 0.15mm (0.006inch). Minimum paper thickness is 0.05 mm or 0.002 inch.
- Paper Path: Rear

(9) Interfaces

- Standard: Centronics Compatible.
- Parallel 8-bit Data
- Data and Control lines

(10) Inked Ribbon

- Color: Black
- Type: Cartridge (Exclusive, Carbon Film type)
- Life Expectancy: 2 million characters

- (11) Line feed time : \approx 200 msec. max. at 4.23 mm (V6) line feed.
- (12) Environmental Conditions
- Operation Temperature Range: 5 ~ 35 °C
- Operating Humidity: 10 ~ 80 % RH (non-condensation)
- (13) Power Requirements
- Voltage (AC): 117 V or 220 V
- Frequency (Hz): 60 Hz or 50/60 Hz
- Power Consumption : Average 40 VA Average 40 VA
- (14) Physical Characteristics
- Height: 113 mm
- Width: 394 mm
- Depth: 287 mm
- Weight: Approximately 4.6 Kg

All specifications are subject to change without notice.

2.

2.1. Switches and Indicators.

There are three switches and three indicators on the control panel and one power switch on the right side of the printer case. Acknowledge its locations to become familiar with operation of printer.

- a. Power switch: Controls primary AC power to the printer. Check the paper is properly set in the printer before turning this switch.
- b. ON LINE switch: When the power switch is turned on the printer enters the On-line mode and can be utilized in conjunction with a host computer.
Depressing the On-line switch will set the printer in the Off-line mode and cause the cd light to go out. It toggle the mode from On-line to Off-line to On-line alternatively.
The switch does not function while the printer is actively engaged in printing.
The printer is automatically placed Off-line if the paper supply is exhausted or if a mechanical error occurs in the printer.
The operation of the line feed and form feed switches are effective only while the printer is Off-line mode.
- c. FF switch: (form feed) When this switch is depressed once, the paper is advanced vertically to the next top of form position. This switch must be depressed while the printer is Off-line mode.
The top of form position is initialized when the power switch is turned on, when INIT signal is applied to the interface connector, or when the ESC @ code is input. Therefore, before turning the power switch on to start operation, set the paper at the appropriate top of form position.
- d. LF switch: (line feed) The paper advances while this switch is being depressed. The line spacing is determined by ESC A + (n)D code.
The line feed operation is prohibited while the printer is actively engaged in printing.
- e. Indicators:
POWER — Illuminates while the AC power is on.
ON-LINE — This light is ON in the On-line mode when the printer is prepared to receive information and blinking in the Ready when the printer is ready to receive information for printing from the computer.
PAPER OUT — Illuminates when the paper supply is near its end.

2.2 . Buzzer.

The buzzer is located inside the printer, and sounds for about 1 second when the printer receives BEL code CHR\$(7), and also when the paper supply is near its end.

2.3 . Paper end detector.

- a. When the paper end detector (sensing switch located on the paper guide) detects that the paper is nearly exhausted, the signals on the interface connector change to the following status, and the printing operation stops.

Signal	Pin No.	Status
ERROR	32	"LOW" level
PE(Paper end)	12	"HIGH" level
BUSY	11	"HIGH" level
ACKNLG	10	No signal is output

Table 1.

To reactivate the printing, take the following procedure as shown in Fig. 1 .

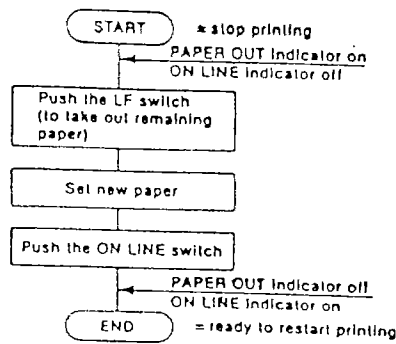

Figure 1 . Flowchart of paper out status release procedure.

- b. When the printer falls into paper-out status, it is automatically put in the OFF-LINE state and paper advancement can be performed by depressing the LF switch. After setting new paper in the printer, depress the ON-LINE switch so that the printer may resume operation.
- c. There is another way to start the printer, again when it falls into paper-out status, set new paper in the printer and turn the power switch off and on again, or apply the INIT signal. In this case, all previously established data are cancelled.
- d. The paper end detecting function is useful to prevent erroneous printing when the printer is out of paper. If printing of characters up to the last line is to be continued, the paper end detecting function may be made invalid by either of the following two methods.
 - (1) Set the DIP switch SW-3 to the ON position, and the paper end-detecting function will become invalid.
 - (2) Enter control code "ESC 8" and the paper end detecting function will become invalid.

All specifications are subject to change without notice.

(SMM804)

No. 6 (5/36)
1985. 5. 20 (Rev. 11A)

3.

3.1 DIP SWITCHES

The DIP switches on the operation panel enable the operator to select wide varieties of control modes and print functions.

The initial factory settings and the operator-selectable modes and functions are shown in the following tables.

Table 2 . DIP SWITCHES

DIP SW No.	Function	ON	OFF	Factory-Set Condition
SW -1	Character size	Condensed (17.77 cpi)	Normal (10 cpi)	OFF
2	Form length	12"	11"	OFF
3	Paper end detector	Invalid	valid	OFF
4	Character Style	<i>Italic</i>	Normal	OFF
5	1 inch skip over perforation	valid	Invalid	OFF
6	Zero Style	∅	0	OFF
7	Buzzer	valid	Invalid	ON

3.2 Pin Connector switches

Table.3. Pin Connector Switches

SW - 1	SW - 2	SW - 3	SW - 4	Function	Remarks
OFF	ON	/	/	AUTO FEED XT Signal externally control	Factory-set
OFF	OFF	/	/	AUTO FEED XT Signal internally not fixed	—
ON	OFF	/	/	AUTO FEED XT Signal internally fixed	—
/	/	OFF	ON	SLCT IN Signal internally DoL fixed	—
/	/	ON	OFF	SLCT IN Signal internally fixed	Factory-set

All specifications are subject to change without notice.

(SMMB04)

No. 7 ⁷36.
1985. 5.20 Rev.11A.

4.

4.1 Self-Test Function

To verify that your printer is operating correctly, you should run the printer test in the Problem Determination Procedures and the printer self-test.

- (1). Set the printer Power switch and the system unit Power switch to Off.
- (2). Disconnect the printer cable from the back of the printer.
- (3). Press and hold the Line Feed key switch down while you set the printer Power switch to ON.
- (4). After the test starts, you can release the Line Feed key switch. All characters provided by the internal software are printed out on the paper.
- (5). The printer self-test will run for about 3 minutes. To stop the printer self-test before it is finished, set the printer Power switch to OFF.
- (6). Below are partial examples of the printout for the Printers.

The printer has a self-test (self-diagnostic) function to check the following.

- (1) Print head operation and printing quality
- (2) Operation of the printer mechanisms (motor, cartridge ribbon mechanism, drive belt, etc.)

Note: The self-test function cannot be performed when the printer is out of paper.

All specifications are subject to change without notice.

(SMM804)

No. B (8 / 36)

1985.5.20(Rev.11A)

4.2 Printer Initialization

Printer initialization is accomplished in one of the three ways described below.

- (1) Initialization takes place automatically each time the primary AC power source is interrupted and reapplied (i.e., by turning the Power Switch OFF and ON).
- (2) Initialization may be initiated remotely by activating the INIT signal to the parallel interface connector.

Upon application of the initialization signal, the following sequence of events take place in the printer.

- 1) The print head returns to its home position.
 - 2) The printer is automatically placed ON-LINE, unless it is out of paper.
 - 3) The print buffer is cleared.
 - 4) The line spacing is set.
 - 5) The form length per page is set.
 - 6) The operation mode reverts to the Text mode.
- (3) Initialization may be initiated programmably upon input of the ESC @ code.

All specifications are subject to change without notice.

5. CONTROL CODES

5.1. Control codes in the text mode.

With this printer, two standard operation modes are available. One is the Text Mode which prints corresponding characters on normal ASCII coded inputs, and the other, the Bit Image Mode which permits printing of pictures and images in dot configurations. The Text Mode is described in this section while the Bit Image Mode is covered in the following section.

This printer has been designed as a terminal unit capable of various software controls. When control codes are transferred to the printer, respective functions governed by these codes such as form feed, line feed, etc. are executed immediately. In order to permit the printer to fully exhibit these functions, careful reading and thorough understanding of the following control codes are recommended. In this section, first the control codes in text mode are classified into groups. These two modes are not fully independent of each other in that parameters set in the Text Mode are also effective in the Bit Image.

a. Print action codes.

CR Carriage return
LF Line feed
VT Vertical tabulation or single line feed
FF Form feed

b. Paper formatting control codes.

ESC D, HT Horizontal tabulation
ESC B, VT Vertical tabulation
ESC Q Column length (right margin)
ESC Ø, ESC 1, ESC 2, ESC 3+n, ESC A, ESC J ... Line spacing
ESC C, FF Form length, form feed
ESC N, ESC O Skip-over perforation
ESC I Sets left margin to n character columns.

c. Character designation codes.

SO, ESC W, DC 4 Enlarged character printing
SI, DC 2 Condensed character printing
ESC E, ESC F Emphasized character printing
ESC G, ESC H Double-strike printing mode
ESC S, ESC T Subscript/superscript printing
ESC - (minus) Underline printing
ESC R International character set Selection
ESC J Master print mode select n
ESC M Set Elite pitch mode
ESC P Cancel Elite pitch mode

d. Other codes:

ESC @ Printer initialization
ESC 8, ESC 9 Selection or deselection of the paper end detector.
CAN Cancel
BEL Buzzer
BS Back space
DEL Delete
NUL Null
ESC < One line unidirectional print. Prints current line only from left to right.
ESC U Unidirectional printing set, reset
ESC 4 Italic character set ON
ESC 5 Italic character set OFF
ESC 6 Locking shift out.
ESC 7 Locking shift in (default)
ESC # Accept eighth bit "as is" from computer
ESC = Clears eighth bit. (i.e. sets to zero.)
ESC > Sets eighth bit to 1.
DC 1 Printer select. (on-line).
DC 3 Printer deselect. (off-line).
ESC ESC Treat as one escape.
ESC SP Ignore spaces until non space.
ESC K, ESC L
ESC Y, ESC ^ Access code to Bit Image mode.

(SMM804)

No. 10 (10/36)
1985.5.20(Rev.11A)

a. Print action codes.

Printer Code	Hex. Codes Decimal Codes	Printer Function
CR	0D 13	CR (carriage return) When the CR code is transmitted to the print buffer, all data stored in the print buffer is printed. When AUTO FEED XT (pin No. 14 of the interface connector) is at "LOW" level, the paper is advanced one line automatically after the execution of printing by the CR code.

Notes: (1) When 80 columns of print data (including spaces) are continuously received and the following data is valid and printable, the printer automatically begins to print the data stored in the print buffer. (In this case, if AUTO FEED XT is at "LOW" level, the paper is advanced one line after printing.)
(2) If no data precedes the CR code, or if all preceding data is SPACE, the carriage assembly does not operate. Under this condition, if AUTO FEED XT is at "LOW" level, only the paper is advanced one line.
(3) When all 80 columns of data are SPACE, the carriage assembly does not operate. Under this condition; if AUTO FEED XT is at "LOW" level, or if the pin switch on the main circuit board SW-1 is ON and SW-2 is OFF respectively, only paper feeding is performed. Refer to page 6.

LF	0A 10	LF (line feed) When the LF code is input, all data in the print buffer is printed and the paper is advanced one line if no data precedes the LF code, or if all preceding data is SPACE, only paper feeding is performed. For example, if the data is transferred in the order of DATA → CR → LF, data will be printed by the CR code, and when the printer receives LF code, it only carries out one line feed, because no print data precedes the LF code.
VT	0B 11	VT (Vertical Tabulation) When that VT code is input, all data preceding this code is printed and the vertical tabulation is made to a predetermined line position set by "ESC B" (up to 16 positions). If no vertical tab position is set by ESC B, the VT code behaves like the LF code. Therefore, the paper is advanced one line after printing.
FF	0C 12	FF (form feed) The FF code causes the printer to execute the printing of all data stored in the print buffer and immediately return carriage to left margin and advances the paper to the next predetermined top of form position.

- Notes: (1) The top of form is determined when the power switch is turned on or the INIT signal is applied, or when the ESC@ code is input.
(2) If the form length per page is not set, one page length of form is regarded as 66 lines set in the ON position.
(3) The form length can be set by ESC C + (n)D or ESC C + (0)D + m as described in this manual.

b. Paper formatting codes.

Printer Code	Hex. Codes Decimal Codes	Printer Function
HT	09 9	HT (horizontal tabulation) The HT code carries out the horizontal tabulation to a predetermined position set by "ESC D" (up to 32 positions). In the absence of any predetermined HT position, the HT code will be ignored. In enlarged character mode, two non-enlarged characters correspond to one enlarged character.

(SMM804)

No. 11 (11/36)
1985, 5.20(Rev.11A)

Printer Code	Hex. Codes Decimal Codes
ESC D	
ESC D; n ₁ ; n ₂ ; ... n _k ; NUL;	
	1B 44
	27 68
	n ₁ n ₂ ... n _k 00

Printer Function
 ESC D + n₁ + n₂ + ... + n_k + NUL
 (1 ≤ (n)D ≤ 142, k ≤ 32)

This code specifies the horizontal tab stop position. "n" denotes column position where the print head stops. The first 32 tab stops per line are recognized in the printer, and subsequent tab stops are ignored. The tab stop positions can be specified up to 80 columns in normal character mode and 142 columns in condensed character mode. The excess tab positions set by the DIP switch or this code will be ignored.

1 ≤ n ≤ 80 in normal character mode
 1 ≤ n ≤ 142 in condensed character mode

In enlarged character mode, two non-enlarged characters must be set as one character. The NUL code should be input as the command for the termination of the tab set sequence, and the lack of this code will cause incorrect data printout.

[PROGRAM]

```
00 LPRINT CHR$(27); "D"; CHR$(5); CHR$(10); CHR$(21);
   CHR$(0);
10 LPRINT "ABC"; CHR$(9); "DEF"; CHR$(9); "GHI";
   CHR$(9); "JKL"
```

[PRINT]

ABC DEF GHI JKL

ESC B	
ESC B; n ₁ ; n ₂ ; ... n _k ; NUL;	
	1B 42
	27 66
	n ₁ n ₂ ... n _k 00

ESC B + n₁ + n₂ + ... + n_k + NUL
 (1 ≤ k ≤ 16, n_k ≤ n_k + 1)

This code specifies the vertical tab stop positions. The first 16 valid tab stops per page are recognized in the Printer; subsequent tab stops are ignored. A tab stop set at a line exceeding the form length specified by ESC C + (n)D is ignored. If the form length is set to 66 lines upon initial power application, the last tab stop (n_k)D should be less than 66.

Tab stop numbers must be received in incremental numerical order. (n_k ≤ n_k + 1) To execute tabulation, the VT code should be input. Once vertical tab stops are established, the data will be valid until new tab stops are specified. If no tab stop is set, the VT code behaves like the LF code. Therefore, the paper is advanced one line after printing. Receipt of "ESC B" code causes the Printer to accept the following codes as tab stop line numbers until the NUL code is input. The lack of the NUL code will cause incorrect data printout.

The form length must be set by "ESC C + (n)D" or "ESC C + (0)D + m" code prior to setting tab stops. The VT setting is cancelled by input of "ESC C + (n)D" code. Therefore, the tab setting should then be established again. Input of "ESC B" code followed by only the NUL code cancels predetermined tab stops.

[PROGRAM EX.]

```
10 "Vertical tabulation"
20 LPRINT "-----Top of Page"
30 LPRINT CHR$(14); CHR$(1); CHR$(1); CHR$(1); CHR$(1);
40 LPRINT CHR$(14); CHR$(1); CHR$(1); CHR$(1); CHR$(1);
50 LPRINT CHR$(14); CHR$(1); CHR$(1); CHR$(1); CHR$(1);
60 LPRINT CHR$(14); CHR$(1); CHR$(1); CHR$(1); CHR$(1);
70 LPRINT CHR$(14); CHR$(1); CHR$(1); CHR$(1); CHR$(1);
80 LPRINT CHR$(14); CHR$(1); CHR$(1); CHR$(1); CHR$(1);
```

[PRINT]

```
-----Top of Page
1 TAB
2 TAB
3 TAB
4 TAB
```

-----TOP TAB-----

(SMM804)

No. 12 (12/36)
1985.5.20(Rev.11A)

Printer Codes	Hex. Codes	Decimal Codes
ESC Q;n	1B 51	n
	27 81	n

Printer Function

ESC Q + (n)D (Sets Column length (right margin))
 The print column width can be specified by inputting ESC Q + (n)D code (1 ≤ n ≤ 142). "n" represents the print column width to be specified in each character size. The Printer will ignore the improper setting of n value.
 1 ≤ n ≤ 80 normal character and emphasized character
 1 ≤ n ≤ 142 condensed character
 1 ≤ n ≤ 40 enlarged character
 1 ≤ n ≤ 71 enlarged-condensed character

[PROGRAM EX.]

```
00 LPRINT "ESC Q+N"
10 FOR I=1 TO 8
20 LPRINT "PRINT WIDTH";I;"COLUMNS"
30 LPRINT CHR*(27);"Q";CHR*(I);
40 GOSUB 90
50 LPRINT CHR*(27);"Q";CHR*(80)
60 NEXT I
80 STOP
90 FOR N=1 TO I*2
92 LPRINT "-";
94 NEXT N
98 RETURN
```

[PRINT]

```
ESC Q+N
PRINT WIDTH 1 COLUMNS          PRINT WIDTH 5 COLUMNS
-----
PRINT WIDTH 2 COLUMNS          PRINT WIDTH 6 COLUMNS
-----
PRINT WIDTH 3 COLUMNS          PRINT WIDTH 7 COLUMNS
-----
PRINT WIDTH 4 COLUMNS          PRINT WIDTH 8 COLUMNS
-----
```

ESC A;n	1B 41	n
	27 65	n

ESC A + (n)D (for setting amount of line spacing)
 This code specified the amount of line spacing in the Line Feed, provided that (n)D must satisfy the condition: 1 ≤ (n)D ≤ 85 (Decimal). "n" = 1 is equivalent to 1/72 inch paper advancement. Since the distance between any two dot wires of the print head is 1/72 inch, any line spacing in increments proportional to the distance between the dot wires can be established.

- Notes: (1) When the POWER switch is turned on or INIT signal is applied to the pin No. 31 of the interface connector, the line spacing is set at 1/6 inch.
 (2) The ESC A + (n)D code may be input at any position on a line. However, once the code is input, the specified amount of line spacing will remain unchanged until a code for new line spacing is set.

[PROGRAM EX]

```
200 LPRINT "ESC A+N"
220 FOR J=1 TO 8
230 LPRINT CHR*(27);"A";CHR*(J);
240 LPRINT "line spacing";J;"1/72 inch"
250 NEXT J
255 LPRINT CHR*(27);"2"
258 LPRINT
```

(SMM804)

No. 14 (14/36)
1985.5.20(Rev.14)

Printer Code	Hex. Codes	Decimal Codes	Printer Function
ESC 2	1B	32	ESC 2 Input of the ESC 2 code causes the subsequent line spacing to be set at 1/6 inch.
	27	50	
ESC 3;n;	1B	33 n	ESC 3+(n)D (1 ≤ n ≤ 127) Input of the ESC 3+(n)D code causes the subsequent line spacing to be set at n/144 inch.
	27	51 n	With n = 1 and n = 2, paper feeding accuracy is not guaranteed. If the value of n is set as 0, this setting is ignored and the value of n set immediately before this code becomes valid.

[PROGRAM EX.]

```
60 LPRINT "ESC 3+N"
80 FOR N=10 TO 20
90 LPRINT CHR*(27);"3";CHR*(N)
100 LPRINT "line spacing";N;" /144 inch"
110 NEXT N
115 LPRINT CHR*(27);"2"
118 LPRINT
```

[PRINT]

ESC C;n;	1B	43 n	ESC C+(n)D (n ≠ 0), ESC C+(0)D+m (for setting form length)
	27	67 n	The "ESC C+(n)D" code specifies the form length which is determined by the number of lines (n: 1 ≤ (n)D ≤ 127 where the value of "n" is a positive number and must not exceed 127 lines). In other words, the maximum form length is 127 lines. The amount of line spacing when this code is input is a predetermined numerical value by ESC A+(n)D. When the form length is not programmed by the ESC C+(n)D code, one page is assumed as 66 lines with the DIP switch SW -2 on the control circuit board set in the OFF position, or 72 lines with the DIP switch SW -2 set in the ON position.
ESC C;0;m;	1B	43 0 m	The "ESC C+(0)D+m" code specifies the absolute quantity of form length in units of inches (1 ≤ (m)D ≤ 22). Therefore, even if the amount of line spacing is changed on the page, the absolute quantity of form length remains unchanged. "m" denotes the form length in inches. If the value of m is set as 0, this setting is ignored and the value of m set immediately before it becomes valid.
	27	67 0 m	
<p>Notes: (1) With the ESC C+(n)D code, the form length can be defined by the number of lines using the amount of line spacing set by the ESC A+(n)D code. With the ESC C+(0)D+m code, the form length can be defined as an absolute quantity in unit of inches.</p> <p>(2) Input of "ESC C" code cancels, the skipover perforation set by "ESC N."</p> <p>(3) (0)D denote decimal 0 and <0>H, hexadecimal 00.</p>			
ESC N;n;	1B	4E n	ESC N+(n)D (n ≠ 0) (for setting skip-over perforation)
	27	78 n	The ESC N+(n)D code is used to set the skip-over perforation function, which specifies the number of lines "n" to be skipped at the bottom of a page (n: 1 ≤ (n)D ≤ 127 where the value of n is positive number). For example, if the last three lines of a page is to be skipped, the value of n must be entered as "3." If the value of n set is greater than the form length specified by the ESC C+(n)D code, skip-over perforation is executed up to the first line of the next page after one line printing. If the value of n is set as 0, this setting is ignored and the value of n set immediately before it becomes valid.

When the current form length is changed by the input of the ESC C + (n)D or ESC C + (n)D + m code again, the amount of skip-over perforation previously set is cancelled. In this case, therefore, the ESC N + (n)D code must be input again to set the amount of skip-over perforation. When the DIP switch SW-5 on the main circuit board is ON, skip-over perforation for 1 inch is executed.

(Example) 2-line skip-over perforation
[PROGRAM EX.]

```
1800 LPRINT CHR*(27) ; "C" ; CHR*(4) ;
1810 LPRINT CHR*(27) ; "N" ; CHR*(2) ;
1820 FOR N=1 TO 6
1830 LPRINT "2 LINE SKIP PERFORATION"
1840 NEXT N
1880 LPRINT CHR*(27) ; "C" ; CHR*(66)
```

[PRINT]

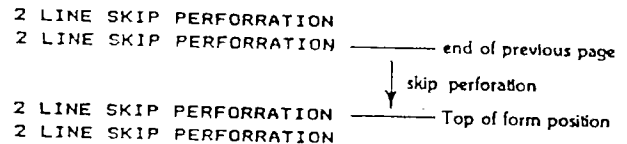

2 LINE SKIP PERFORATION
2 LINE SKIP PERFORATION

ESC O 1B 4F
 27 79

ESC O
This code cancels the skip-over perforation set by the ESC N + (n)D code.

ESC J;n; 1B 4A n
 27 74 n

ESC J + (n)D (Paper Feed Execution Command) (1 ≤ n ≤ 127)
This code causes the printer to execute paper feeding by n/144 inch. With n=1 and n=2, paper feeding accuracy is not guaranteed. If the value of n is set as 0, no paper feeding will be executed. In any case, the set value of n will not remain in the memory.

[PROGRAM EX.]

```
1700 LPRINT CHR*(14) ; "ESC J+N"
1710 FOR N=10 TO 25
1720 LPRINT "-----" ; CHR*(13) ; CHR*(27) ; "J" ;
          CHR*(N) ; "-----" ; N
1730 NEXT N
```

[PRINT]

(SMM804)

No. 16 (16 / 36)
1985. 5.20 (Rev.11A)

Printer Codes	Hex. Codes Decimal Codes	Printer Function
ESC I; n,	1B 6C n 27 10B n	ESC I + (n) (Sets left margin) This code sets the left margin in the current character size. There is a maximum value for "n" in each character size and if the excess value for "n" is set, it will be ignored. For "n", refer to ESC Q. Notes: (1) Setting of the left margin is performed in normal character size in Proportional mode. (2) When the left margin is set by inputting the ESC I code, the right margin in Condensed mode will be at the same position as that in Normal mode. (3) Input of the ESC I code causes the horizontal TAB positions previously set to be cleared and the subsequent horizontal TAB setting is carried out assuming the start column position set by the ESC I as position 0.

(SMM804)

No. 17 (1/36)
1985.5.20(Rev.11A)

C. Character designation codes

Printer Code	Hex. Codes Decimal Codes	Printer Function
SO	0E 14	SO (Shift Out) (for enlarged characters) When the SO code is input, all data that follows this code on the same line will be printed out in double-width enlarged characters. This code is cancelled by the line feed or the input of "DC 4", ESC I or ESC W code and can be input at any column position on a line. Therefore, normal size and enlarged characters can be mixed on the same line.

Note: With normal size and enlarged characters mixed on the same line, when any enlarged character is at the 80th column position in terms of normal size character, this position becomes the end position of the line (i.e., "Print Buffer Full" position).

[PROGRAM EX.]

```
24 LPRINT "ABCD";CHR*(0E);"EFGH";CHR*(0E);CHR*(0A);
26 LPRINT "IJKL";CHR*(0E);"MNOP"
```

[PRINT]

ABCDEFGHIH

IJKLMNOP

SI	0F 15	SI (Shift In) (for condensed characters) When the SI code is input, all data stored in the buffer is printed and the following data will be printed out in condensed characters. This code is cancelled by the input of "DC 2" code. The SI code can be input at any column position on a line. When printing condensed characters, the data capacity of the print buffer will become 142 columns per line (in terms of condensed size character).
----	----------	-------------------------------------------------------------------------------------------------------------------------------------------------------------------------------------------------------------------------------------------------------------------------------------------------------------------------------------------------------------------------------------------------------------------------------------------------------

DC2	12 18
-----	----------

DC 2 (Device Control 2)

The DC 2 code cancels the condensed mode set by SI code. This command causes condensed (compressed width) mode off with buffer flush.

[PROGRAM EX.]

```
30 LPRINT CHR*(0F);"ABCDEFGHIJKLMN"
32 LPRINT CHR*(18)
```

[PRINT]

ABCDEFGHIJKL

DC4	14 20
-----	----------

DC 4 (Device Control 4)

The DC 4 code cancels the SO mode (enlarged character printing function). This DC 4 command terminates only an SO --- not "ESC I" or "ESC W".

[PROGRAM EX.]

```
20 LPRINT "ABCD";CHR*(0E);"EFG";CHR*(0E);"HIJ"
```

[PRINT]

ABCDEFGHIJ

[PROGRAM EX.]

```
46 LPRINT CHR*(LHF)*"ABCDEF";CHR*(LHE)*"GHI";
   CHR*(LHD);CHR*(LHA)
48 LPRINT CHR*(18)*"JKLMN"
```

[PRINT]

AKMTGHI
JKLMN

ESC E 1B 45
27 69

ESC E (for emphasized characters)
When the ESC E code is input, all the data stored in the print buffer will be printed out and the data following this code will be printed in emphasized characters. Emphasized character printing gives the character a stronger impression on the paper.

This code can be input at any column position on a line. The speed of the head carriage reduces to half speed while printing emphasized characters.

ESC F 1B 46
27 70

ESC F
The ESC F code cancels the emphasized character printing mode set by ESC E code.

[PROGRAM EX.]

```
00 A$=CHR*(27)
10 LPRINT A$;"E";"ABCDE";A$;"F";"FGHIJ";CHR*(LHD);
   CHR*(LHA)
20 LPRINT CHR*(15)*"ABCD";A$;"E";"EFGH";
   A$;"F";"IJKL";CHR*(18);CHR*(LHD);CHR*(LHA)
30 LPRINT CHR*(14)*"ABCD";A$;"E";"EFGH";
   A$;"F";"IJKL"
```

[PRINT]

ABCDEFGHIJ
.
ABCDEFGHIJL
ABCDEFGHIJKL

ESC G 1B 47
27 71

ESC G (for double printed characters)
When the ESC G code is input, all the data stored in the printer buffer will be printed out and the data following this code will be printed in double print character mode. In this mode, the printer will complete one line of printing by two passes of the print head while advancing the paper by about 1/216 inch between the first pass and the second pass. For this reason, this printer performs paper feeding adjustment to maintain the absolute length and number of lines of a page. However, if any data are printed in this mode as a result of the BUFFER FULL condition, the printer will not perform this adjustment. Therefore, the form length of a page on which the printing resulting from the BUFFER FULL condition is performed will become different from that initially set for the page.

ESC H 1B 48
27 72

ESC H
The ESC H code cancels the double print character mode set by ESC G code and super/sub-script mode set by ESC S code.

[PROGRAM EX.]

```
1600 LPRINT CHR*(27)*"G";"ABCDE";CHR*(LHD);CHR*(LHA)
1610 LPRINT "FGHIJ";CHR*(27)*"H";"KLMNO"
```

[PRINT]

ABCDE
FGHIJKLMNO

Printer Code	Hex. Codes	Decimal Codes	Printer Function
ESC S ; 0 ;	1B 53	00	ESC S + (n)D (for superscript and subscript characters) (n = 0 or 1) When the ESC S + (0)D code is input, all the data stored in the print buffer will be printed out and the data following this code will be printed in superscript character mode. In this mode, a character measuring 2.2 (W) x 1.4 (H) mm will be printed at the upper half of a line. When the ESC S + (1)D code is input, all the data stored in the print buffer will be printed out and the data following this code will be printed in subscript character mode. In this mode, a character will be printed at the lower half of a line.
	27 83	0	
ESC S ; 1 ;	1B 53	01	In both the superscript and subscript character modes, the printer will perform unidirectional, double character printing. After the first pass of the print head, the paper will be advanced by 1/216 inch and a character will be formed on completion of the second pass. For this reason, the printer will perform paper feeding adjustment to maintain the absolute length and number of lines of a page. Because of this adjustment subscript or superscript characters may in the worst case be printed improperly.
	27 83	1	

[PROGRAM EX.]

```

2000 LPRINT
2010 ESC$=CHR$(27)
2020 LPRINT ESC$;"E"ESC$;"G";"Y=AX"
2030 LPRINT ESC$;"F"
2040 LPRINT ESC$;"S"CHR$(0);CHR$(15);"3"
2050 LPRINT ESC$;"T"CHR$(18)
2070 LPRINT ESC$;"E"ESC$;"H";"+BX"
2075 LPRINT ESC$;"F"
2080 LPRINT ESC$;"S"CHR$(0);CHR$(15);"2"
2090 LPRINT ESC$;"T"CHR$(18)
2100 LPRINT ESC$;"E"ESC$;"H";"+CX+D"
2110 LPRINT ESC$;"F"

```

[PRINT]

Y=AX+BX+CX+D

ESC T	1B 54	ESC T
	27 84	The ESC T code cancels the superscript/subscript character mode and unidirectional print modes off.
ESC W;0;	1B 57	ESC W + (n)D (for double-width enlarged character set/reset) (n = 0 or 1) When the ESC W + (1)D code is input, all the data following this code will be printed out in double-width enlarged characters. This code is cancelled upon input of the ESC W + (0)D (but cannot be cancelled by "DC 4" code or "LF" code). The ESC W + (0)D code cancels the double-width enlarged character mode set by the ESC W + (1)D code. However, this code cannot cancel the enlarged character mode set by the SO code.
	27 87	
ESC W;1;	1B 57	When the ESC W + (1)D code is input in the enlarged character mode set by the input of the SO code, or the SO code is input in the enlarged character mode set by the ESC W + (1)D code, ESC W + (1)D takes precedence over SO. To cancel the enlarged character mode in this case, the ESC W + (0)D code must be entered.
	27 87	
ESC - ; 0 ;	1B 2D	ESC - (minus) + (n)D (for underline print mode set/reset) (n = 0 or 1) Input of the ESC - (minus) + (1)D code places the Printer in the underline print mode. All the data following this code will be printed with an underline. The ESC - (minus) + (0)D code cancels the underline print mode.
	27 45	
ESC - ; 1 ;	1B 2D	
	27 45	1

(SMM804)

No. 20 (20/36)
1985.5.20(Rev.11A)

[PROGRAM EX.]

```

300 LPRINT "ESC - +N UNDER LINE"
310 ESC*=CHR*(27)
320 GOSUB 410
330 LPRINT CHR*(15);
340 GOSUB 420
350 LPRINT CHR*(18);
360 LPRINT ESC*;"E";
370 GOSUB 410
380 LPRINT ESC*;"F";
38B LPRINT
390 STOP
410 LPRINT "    normal";
420 LPRINT ESC*;"-";CHR*(1);
430 LPRINT "underlined printing";
440 LPRINT ESC*;"-";CHR*(0);
450 LPRINT "normal"
460 RETURN
  
```

[PRINT]

ESC - +N UNDER LINE
 normalunderlined printingnormal
 underlined printingnormal
 normalunderlined printingnormal

ESC R;n; 1B 52 n
 27 82 n

ESC R + (n)D (for international character set) (0 ≤ n ≤ 11)
 When the "ESC R + (n)D" code is input, all data following this code will be printed out in a country character set which is specified by n. It will be valid until specified by other "ESC R + (n)D" code. "n" represents one of the following country character sets. Refer to page 30~32.

n	Country	
	Shift In area (GL-Graphics Left)	Shift Out area (GR-Graphics Right)
0	ISO United Kingdom	ASCII United States
1	ASCII United States	DRI Upper Set (DEFAULT)
2	ISO Finland	ASCII United States
3	ISO Norway / Denmark	ASCII United States
4	ISO Sweden	ASCII United States
5	JIS Japan Roman	JIS Japan Katakana
6	JIS Japan Katakana	ASCII United States
7	ISO Germany	ASCII United States
8	ISO French Canada	ASCII United States
9	ISO France	ASCII United States
10	ISO Italy	ASCII United States
11	ISO Spain	ASCII United States

	35	36	64	91	92	93	94	96	123	124	125	126
DECIMAL	23	24	40	5B	5C	5D	5E	60	7B	7C	7D	7E
United Kingdom	E	\$	@	[\]	^	_	{		}	~
United States	#	\$	@	[\]	^	_	{		}	~
Finland	#	\$	@	Ä	Ö	Å	Ü	ä	ö	å	ü	~
Norway / Denmark	#	\$	Å	Æ	Ø	Å	Ü	æ	ø	å	ü	~
Sweden	#	\$	É	Å	Ö	Å	Ü	é	ö	å	ü	~
Japan Roman	#	\$	@	[*]	^	_	{		}	~
Japan Katakana	#	\$	@	[*]	^	_	{		}	~
Germany	#	\$	\$	Ä	Ö	Ü	À	Á	Â	Ã	Ä	Å
French Canada	#	\$	\$	À	Á	Â	Ã	Ä	Å	Æ	Ç	È
France	E	\$	\$	À	Á	Â	Ã	Ä	Å	Æ	Ç	È
Italy	E	\$	\$	À	Á	Â	Ã	Ä	Å	Æ	Ç	È
Spain	E	\$	\$	À	Á	Â	Ã	Ä	Å	Æ	Ç	È

Notes: *DRI Upper Set --- Digital Research Upper Set . Refer to page 30

1465

Printer Code	Hex. Codes Decimal Codes	Printer Function
ESC M	18 4D 27 77	ESC M (Elite sized mode setting) Input of ESC M code causes the data following this code to be printed in "ELITE" size (12 characters per inch). Emphasized on condensed mode setting is ignored in this "ELITE" mode.

[PROGRAM EX.]

```

7 'Control Command: ESC M
9 'Open Printer Device
10 OPEN "O",1,"LPT0:(N)"
13 'Define Control Codes
20 30=CHR(14):HT=CHR(9):ESC=CHR(27):LF=CHR(10)
2390 PRINT #1,ESC;"ESC M"
2400 PRINT #1,HT;"Select Elite Size"
2410 PRINT #1,ESC;"M"
2420 FOR I=32 TO 124
2440 PRINT #1,CHR(I)
2450 NEXT I:PRINT #1,ESC;"P";LF
    
```

[PRINT]

```

ESC M
Select Elite Size
"ESC M",1,20122454789:ESC=CHR(27):HT=CHR(9):LF=CHR(10)
    
```

ESC P	18 50 27 80	ESC P (Cancel Elite mode.)
-------	----------------	----------------------------

This code cancels the "ELITE" sized mode.

ESC ! n	18 21 n 27 33 n	ESC ! + (n)D (print mode selection) This code specifies the print mode. $0 \leq n \leq 255$ Each print mode is determined by the value of n as follows.
---------	--------------------	---------------------------------------------------------------------------------------------------------------------------------------------------------------

n = 0 — "PICA" mode	n = 32 — enlarged mode
n = 1 — "ELITE" mode	n = 33 — "ELITE"/enlarged mode
n = 4 — condensed mode	n = 36 — condensed/enlarged mode
n = 8 — emphasized mode	n = 40 — emphasized/enlarged mode
n = 16 — double strike mode	n = 48 — double strike/enlarged mode
n = 17 — "ELITE"/double strike mode	n = 49 — "ELITE"/double str./enlarged
n = 20 — condensed/double strike mode	n = 52 — cond./double str./enlarged
n = 24 — emphasized/double strike mode	n = 56 — empha./double str./enlarged

This code takes precedence over other commands which set the print mode.

Definition of each bit for n

Bit	7	6	5	4	3	2	1	0
1	Underline	Italics	Double width	Double strike	Empha-sized (bold)	Condensed	—	Elite
0	—	—	—	—	—	—	—	Pica

(SMM 804)

No. 22 (22/36)
1985.5.20(Rev.11A)

d. Other codes

Printer Code	Hex. Codes	Decimal Codes	Printer Function
ESC @	1B	40	ESC @ (Printer Initialization) Input of the ESC @ code causes the Printer to be initialized.
ESC 8	27	64	ESC 8 (Escape 8) (to ignore the Paper End Detector) The ESC 8 code makes it possible to transmit data even if there is no paper in the Printer. Since this code causes the PE signal to be ignored, data may be printed to the last page of the form without waste of paper. With the DIP switch SW -3 on the main circuit board set in the ON position, the Printer is placed in the ESC 8 condition upon application of power.
	1B	38	
ESC 9	27	56	ESC 9 (Escape 9) This code cancels the ESC 8 condition, and reinstates the PE signal. Therefore, the printer cannot receive data when there is no paper. With the DIP switch SW -3 set in the OFF position, the Printer is placed in the ESC 9 condition upon application of power.
	1B	39	
BEL	07	7	BEL (Bell) When the BEL code is input, the buzzer sounds for about 1 second. Optional use of this code is recommended to arouse the attention of the operator.
BS	08	8	BS(Backspace) When the BS code is input, the data stored in the buffer is printed and the buffer pointer is decremented by 1. The next character will overstrike the last character printed. In the enlarged character mode, BS is effective only for the last byte.

[PROGRAM EX.]

52 LPRINT "ABCDE";CHR\$(8);"0123"

[PRINT]

ABCDE123

[PROGRAM EX. 2]

56 LPRINT "ABCDE";CHR\$(8);CHR\$(8);"01234"

[PRINT]

ABCDE234

DEL	7F		DEL (Delete) Input of the DEL code causes the last byte stored in the print buffer to be cleared.
	127		
NUL	00		NUL (Null) The NUL code is used with ESC B and ESC D as a list terminator. At the TAB setting, the lack of this code will cause incorrect data print out. NUL is also used with other printer control codes to select options (e.g., ESC U, etc.).
	0		
ESC Y			ESC Y Input of this code in the Text Mode causes the Printer's operation mode to be converted from Text to 1200 dots/inch Bit Image. Refer to page 24.
ESC A			ESC A Input of this code in the Text Mode causes the Printer to perform 9-pin bit Image printing. Refer to page 25.
ESC U; 0;	1B	55	ESC U + (n)D (n = 0 or 1) When the ESC U + (1)D code is input, printing of all the data following this code will be performed unidirectionally with the print head moving from the left to the right.
	27	85	
ESC U; 1;	1B	55	The ESC U + (0)D code cancels the unidirectional printing mode. Use of this code for printing graphs and charts in the unidirectional printing mode assures more accurate printing start position with better printing quality.
	27	85	
ESC ESC	1B	18	ESC ESC Treat as one ESC.
	27	27	

(SMM804)

No. 23 (23/36)
1985.5.20(Rev.11A)

Printer Code	Hex. Codes Decimal Codes	Printer Function
CAN	1 8	CAN (Cancel)
	2 4	Cancel and clear the print buffer.
ESC SP	1B 20	ESC SP
	27 32	Ignore spaces until a valid escape sequence qualifier or 8 full space character is received.
ESC #	1B 23	ESC #
	27 35	Accept eighth bit "as is" from computer. (default).
ESC 4	1B 34	ESC 4
	27 52	Italic character Set ON.
ESC 5	1B 35	ESC 5
	27 53	Italic character Set OFF.
ESC <	1B 3C	ESC <
	27 60	One line unidirectional Print. Prints current line only from left to right.
ESC =	1B 3D	ESC =
	27 61	Clears eighth bit (i.e. Sets to zero.)
ESC >	1B 3E	ESC >
	27 62	Sets eighth bit to 1.
ESC 6	1B 36	ESC 6 (Locking Shift Out)
	27 54	This code will be used to shift out the current GL (Graphics left, i.e. (20)_H to (7E)_H) set and replaces it with the GR (Graphics right, i.e. (A0)_H to (FE)_H) set (i.e., set bit to 1).
ESC 7	1B 37	ESC 7 (Locking Shift In)
	27 55	This code will be used to shift in the original GL (Graphics left, i.e. (20)_H to (7E)_H) set (i.e. leave bit 8 as 1s). (default). Refer to page 20 and 29-31.
DC 1	17	DC 1 (selection of the printer) The DC 1 code places the printer in the Selected-state. It enables the printer to receive data — On-line condition. This code is applicable only for returning the state from Deselect-state (Off-line) which had defined by DC 3 code.
DC 3	19	DC3 (deselection of the printer) The DC3 code places the printer in the Deselected-state (Off-line) Relations among the ON-LINE switch, SLCT IN signal, DC1/DC3 code and interface signals are shown in the table below.

relations among ON-LINE, SLCT IN, DC1/DC3 and Interface Signal

ON-LINE Switch	SLCT IN Signal	DC1/DC3	ERROR	BUSY	ACKNLG	DATA ENTRY
OFF-LINE	HIGH/LOW	DC1/DC3	LOW	HIGH	Not generated	Unable
ON-LINE	HIGH	DC1	HIGH	LOW/HIGH	Generated	Enable (Normal entry)
		DC3	HIGH	LOW/HIGH	Generated	Enable (See Note 2.)
	LOW	DC1/DC3	HIGH	LOW/HIGH	Generated	Enable (Normal entry)

- NOTES: 1. In the above table, it is assumed that no ERROR status exists other than that attributable to the OFF-LINE mode.
2. Once DC3 is input and the printer enters the Deselected state, it will remain in that state until DC1 is input. In other words, while the printer is in the Deselected state, all input data will be invalid.

All Undefined control codes are to be ignored.
All specifications are subject to change without notice.

5.2. Control Codes In the Bit Image Mode

Printer Code	Hex. Codes	Decimal Codes	Printer Function
ESC K ; n ₁ ; n ₂ ; v ₁ ; v ₂ ; ... ; v _k	1B 4B	27 75	Most of the abovementioned control codes are normally used in the text mode. Control codes associated with the Bit Image mode will be discussed next.

480 bit image mode setting by ESC K + n1 + n2

To convert the printer's operation mode from Text to 480 dots Bit Image, the "ESC K + n1 + n2" code must be input. (Here, the sign "+" is inserted for the purpose of legibility only and should not be input in actual operation.) Namely, when ESC [(27)D or (155)D] and K [(75)D] codes and data n1 and n2 are input, the Printer recognizes the data following the "ESC K" as the bit image data. n1 and n2 are the decimal numbers each consisting of 2 digits which define the amount of the bit image data to be transferred. n1 represents the low-order two digits while n2 represents the high-order two digits.

v₁ through v_k are the bytes of the bit-image data. The number of bit-image data bytes(k) is equal to n₁ + 256n₂ and can not exceed 480 bytes. At every horizontal position, each byte can print up to 8 vertical dots. Horizontally adjacent dots are not printed. In the 480 dots bit image processing, the maximum number of dot positions printable per line is 480. Therefore, the values of n1 and n2 specified in excess of 480 dot positions are ignored and printing of the bit image data after the 480th dot position is not guaranteed. Mixing of text data and bit image data is possible on the same line.

Note: Assign values to n1 and n2, respectively as follows.

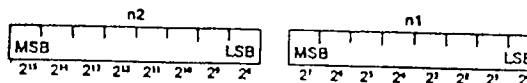

As shown above, n1 is set decimally as low-order bytes and n2 as high-order byte.

Text (20 characters)	ESC K	n = 480 bit-image data	Next data
----------------------	-------	------------------------	-----------

20 characters in text mode correspond to 120 bit-image positions (20 x 6 = 120). So the remaining printable positions in Bit-image mode are 360 (480 - 120 = 360). If 480 data are input as bit-image mode characters, the first 360 data can be printed but the remaining 120 data are ignored and thus not printed.

(Ex. 2) Input data

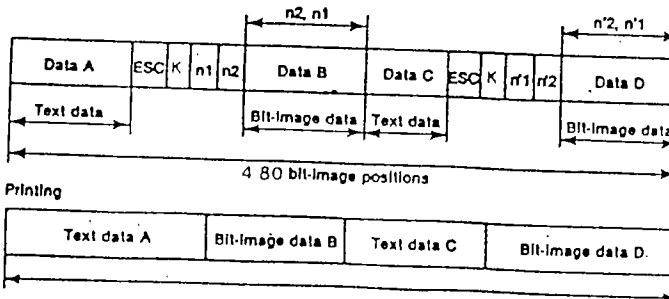

(Ex. 3) Bit Image data transfer by standard BASIC program to check for proper conversion to the Normal-density Bit Image mode, execute the following program.

(SMM804)

No. 25 (25/36)
1985. 5. 20 (Rev. 11A)

Printer Code	Hex. Codes Decimal Codes	Printer Function
--------------	-----------------------------	------------------

```

[PROGRAM EX.]
4200 LPRINT CHR$(27);"2"
4210 LPRINT "GRAPHIC MODE (ESC +Y)"
4220 LPRINT CHR$(27);"A";
4230 LPRINT CHR$(8);
4240 FOR L=1 TO 5
4250 LPRINT CHR$(27);"Y";
4260 LPRINT CHR$(120);CHR$(0);
4270 FOR LO=1 TO 15:FOR LI=0 TO 7
4280 LPRINT CHR$(2^LI);
4290 NEXT LI:NEXT LO
4292 LPRINT
4294 NEXT L:LPRINT CHR$(27);"2";
[PRINT]
GRAPHIC MODE (ESC +Y)

```



ESC L
 ESC L;n₁;n₂;v₁;v₂;...v_k;
 1B 4C
 27 76
 n₁ n₂ v₁ v₂ ... v_k

Escape L (960 Bit Image Mode --- 8 pins)

Causes to change the print mode from text mode to 960 Bit-Image mode. The input is similar to the case of ESC K. 960 Bit-Image mode effects printing at lower speed than that of 480 Bit-Image Graphics mode, but can produce a denser graphic image. The number of bytes of bit-image data (k) is n₁ + 256n₂ but can not exceed 960. n₁ and n₂ is in the range of 0 to 255.

ESC Y; n₁;n₂;v₁;v₂;...v_k;
 1B 59
 27 89
 n₁ n₂ v₁ v₂ ... v_k

Escape Y (1280 Bit Image Mode --- 8 pins)

CHRS (27); " "; CHRS (n); CHRS (n)D;
 When the [(27)D] or [(156)D] and [(89)D] codes followed by data n₁ and n₂ are input, the printer's operation mode is converted from Text to 1280 Bit Image. The transfer sequence of bit image data is the same as with the ESC K (normal-density bit image printing). The number of bytes of bit image data is n₁ + 256n₂ but can not exceed 1280. n₁ and n₂ is in the range of 0 to 255.

ESC A; n; n₁;n₂;v₁;v₂;...v_k;
 1B 5E
 27 94
 n n₁ n₂ v₁ v₂ ... v_k

9-pin bit image mode setting by ESC A n m n

This code sets 9-pin bit image mode.
 n value should be defined as follows.
 n = 0 — 480 dots/line bit image mode.
 n = 1 — 960 dots/line bit image mode.
 n = 3 — 1280 dots/line bit image mode.

All Undefined Control codes are to be ignored.
 All specifications are subject to change without notice.

(SMM804)

No 26 (26/36)
1985.5.20(Rev.11A)

HOW TO OBTAIN n1 and n2 VALUES — same as for ESC K, ESC L and ESC Y.

As shown in the figure, the 9 pins in the head are divided into the upper 8 pins and the lowest pin, which print in the order of the first and second bytes. These two bytes together control the pattern for a single dot position.

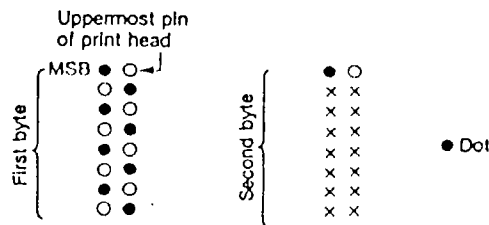

In the figure, data will be sent in the following order.

CHR\$ (170); CHR\$ (128); CHR\$ (85); CHR\$ (0);

Differing from other bit image print codes, the number of dot positions to be printed becomes half of the total number of data sent after n1 and n2.

All undefined control codes are to be ignored.

All specifications are subject to change without notice.

(SMM804)

No. 27 (27/36)
1985. 5.20 (Rev. 11A)

6. ASCII CHART

ASCII CHART

	0	1	2	3	4	5	6	7
	0000	0001	0010	0011	0100	0101	0110	0111
0	0000	0001	0010	0011	0100	0101	0110	0111
1	0001	0010	0011	0100	0101	0110	0111	
2	0010	0011	0100	0101	0110	0111		
3	0011	0100	0101	0110	0111			
4	0100	0101	0110	0111				
5	0101	0110	0111					
6	0110	0111						
7	0111							
8	1000	1001	1010	1011	1100	1101	1110	1111
9	1001	1010	1011	1100	1101	1110	1111	
A	1010	1011	1100	1101	1110	1111		
B	1011	1100	1101	1110	1111			
C	1100	1101	1110	1111				
D	1101	1110	1111					
E	1110	1111						
F	1111							

	0	16	32	48	64	80	96	112
DEC	0	1	2	3	4	5	6	7
0	0	NUL						
1	1		SOH					
2	2		STX					
3	3		ETX					
4	4		ETX					
5	5		W					
6	6							
7	7	BEL						
8	8	BS	CAN					
9	9	HT						
10	A	LF						
11	B	VT	ESC					
12	C	FF						
13	D	CR						
14	E	SO						
15	F	SI						DEL

All Undelined codes are to be ignored.
All specifications are subject to change without notice.

(SMM804)

No. 28 (²⁸ / 36)
1985.5.20 (Rev. 11A)

7 . Interface

Connector use — Data exchange between the this printer and an external computer (parallel).

Number of pins — 36

Part number — 57-30360 (AMPHENOL TYPE)

Pin assignment — Refer to the below table.

Signal Pin No.	Return Pin No.	Signal	Direction	Description
1	19	STROBE	In	STROBE pulse of read data in. Pulse width must be more than 0.5 μ s at receiving terminal. The signal level is normally "HIGH", read-in of data is performed at the "LOW" level of this signal.
2	20	DATA 1	In	These signals represent information of the 1st to 8th bits of parallel data respectively. Each signal is at "HIGH" level when data is logical "1" and "LOW" when logical "0".
3	21	DATA 2	In	
4	22	DATA 3	In	
5	23	DATA 4	In	
6	24	DATA 5	In	
7	25	DATA 6	In	
8	26	DATA 7	In	
9	27	DATA 8	In	
10	28	ACKNLG	Out	Approx. 5 μ s pulse. "LOW" indicates that data has been received and that the printer is ready to accept other data.
11	29	BUSY	Out	A "HIGH" signal indicates that the printer cannot receive data. The signal becomes "HIGH" in the following cases: 1. During data entry 2. During printing operation 3. In OFF-LINE state 4. During printer error status.
12	30	PE	Out	A "HIGH" signal indicates that the printer is out of paper.
13	—	SLCT	Out	This signal indicates that the printer is in the selected state.
14	—	AUTO FEED XT	In	With this signal being at "LOW" level, the paper is automatically fed one line after printing. (The signal level can be fixed to "LOW" with the Pin SW-1 and SW-2 provided on the control circuit board.)
15	—	NC	—	Not used.
16	—	OV	—	Logic GND level

NOTE : Interface cable

In the case of an ATARI 16 bit computer, the interface cable should have a 25-pin D-shell connector on its end toward the 16 bit computer and a 36-pin connector on its end toward the printer.

In the case of other computers with centronics compatible interfaces or its equivalent, the interface cable, in that case, should have a 36-pin connector to 36-pin connector on the computer and the printer.

Signal Pin No.	Return Pin No.	Signal	Direction	Description
17	—	CHASSIS-GND	—	Printer chassis GND. In the printer, the chassis GND and the logic GND are isolated from each other.
18	—	NC	—	Not used.
19 to 30	—	GND	—	TWISTED-PAIR RETURN signal GND level.
31		INIT	In	When the level of this signal becomes "LOW", the printer controller is reset to its initial state and the print buffer is cleared. This signal is normally at "HIGH" level, and its pulse width must be more than 50 μ s at the receiving terminal.
32		ERROR	Out	The level of this signal becomes "LOW" when the printer is in — 1. PAPER END state 2. OFF-LINE state 3. Error state
33		GND		Same as with Pin Nos. 19 to 30.
34		NC		Not used
35				Pulled up to +5V through 3.3k Ω resistance.
36		SLOT IN	In	Data entry to the printer is possible only when the level of this signal is "LOW". (Internal fixing can be carried out with SW3, SW4. The condition at the time of shipment is set "LOW" for this signal.)

- Notes: 1. "Direction" refers to the direction of signal as viewed from the printer.
 2. "Return" denotes "TWISTED-PAIR RETURN" and is to be connected at signal ground level. As to the wiring for the interface, be sure to use a twisted-pair cable for each signal and never fail to complete connection on the Return side. To prevent noise effectively, these cables should be shielded and connected to the chassis of the host computer and the printer, respectively.
 3. All interface conditions are based on TTL level. Both the rise and fall times of each signal must be less than 0.2 μ s.
 4. Data transfer must not be carried out by ignoring the ACKNLG or BUSY signal. (Data transfer to this printer can be carried out only after confirming the ACKLG signal or when the level of the BUSY signal is "LOW".) Time chart is below,
 Data Transmission Sequence

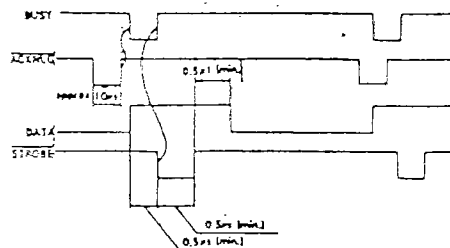

All specifications are subject to change without notice.

APPENDIX A.

1. ESC R n --- Select International character set (0 ≤ n ≤ 11)
Refer to page 20.

n = 0 : United Kingdom

	Shift In.								Shift Out							
	0	1	2	3	4	5	6	7	8	9	A	B	C	D	E	F
0	0	8	P	'	p				0	8	P	'	p			
1	!	1	A	Q	a	q			!	1	A	Q	a	q		
2	"	2	B	R	b	r			"	2	B	R	b	r		
3	#	3	C	S	c	s			#	3	C	S	c	s		
4	\$	4	D	T	d	t			\$	4	D	T	d	t		
5	%	5	E	U	e	u			%	5	E	U	e	u		
6	&	6	F	V	f	v			&	6	F	V	f	v		
7	'	7	G	U	g	w			'	7	G	U	g	w		
8	(8	H	X	h	x			(8	H	X	h	x		
9)	9	I	Y	i	y)	9	I	Y	i	y		
A	*	:	J	Z	j	z			*	:	J	Z	j	z		
B	+	<	K	\	k	(+	<	K	\	k	(
C	,	<	L	\	l	(,	<	L	\	l	(
D	-	=	M]	m)			-	=	M]	m)		
E	.	>	N	^	n	~			.	>	N	^	n	~		
F	/	?	O	_	o	~			/	?	O	_	o	~		

GL(Graphics Left) GR(Graphics Right)

n = 1 : ASCII United States

	Shift In.								Shift Out							
	0	1	2	3	4	5	6	7	8	9	A	B	C	D	E	F
0	0	8	P	'	p				0	8	P	'	p			
1	!	1	A	Q	a	q			!	1	A	Q	a	q		
2	"	2	B	R	b	r			"	2	B	R	b	r		
3	#	3	C	S	c	s			#	3	C	S	c	s		
4	\$	4	D	T	d	t			\$	4	D	T	d	t		
5	%	5	E	U	e	u			%	5	E	U	e	u		
6	&	6	F	V	f	v			&	6	F	V	f	v		
7	'	7	G	U	g	w			'	7	G	U	g	w		
8	(8	H	X	h	x			(8	H	X	h	x		
9)	9	I	Y	i	y)	9	I	Y	i	y		
A	*	:	J	Z	j	z			*	:	J	Z	j	z		
B	+	<	K	\	k	(+	<	K	\	k	(
C	,	<	L	\	l	(,	<	L	\	l	(
D	-	=	M]	m)			-	=	M]	m)		
E	.	>	N	^	n	~			.	>	N	^	n	~		
F	/	?	O	_	o	~			/	?	O	_	o	~		

GL(Graphics Left) GR(Graphics Right)
DRI Upper_Set

n = 2 : Finland

	Shift In.								Shift Out							
	0	1	2	3	4	5	6	7	8	9	A	B	C	D	E	F
0	0	8	P	'	p				0	8	P	'	p			
1	!	1	A	Q	a	q			!	1	A	Q	a	q		
2	"	2	B	R	b	r			"	2	B	R	b	r		
3	#	3	C	S	c	s			#	3	C	S	c	s		
4	\$	4	D	T	d	t			\$	4	D	T	d	t		
5	%	5	E	U	e	u			%	5	E	U	e	u		
6	&	6	F	V	f	v			&	6	F	V	f	v		
7	'	7	G	U	g	w			'	7	G	U	g	w		
8	(8	H	X	h	x			(8	H	X	h	x		
9)	9	I	Y	i	y)	9	I	Y	i	y		
A	*	:	J	Z	j	z			*	:	J	Z	j	z		
B	+	<	K	\	k	(+	<	K	\	k	(
C	,	<	L	\	l	(,	<	L	\	l	(
D	-	=	M]	m)			-	=	M]	m)		
E	.	>	N	^	n	~			.	>	N	^	n	~		
F	/	?	O	_	o	~			/	?	O	_	o	~		

GL(Graphics Left) GR(Graphics Right)

n = 3 : Norway / Denmark

	Shift In.								Shift Out							
	0	1	2	3	4	5	6	7	8	9	A	B	C	D	E	F
0	0	8	P	'	p				0	8	P	'	p			
1	!	1	A	Q	a	q			!	1	A	Q	a	q		
2	"	2	B	R	b	r			"	2	B	R	b	r		
3	#	3	C	S	c	s			#	3	C	S	c	s		
4	\$	4	D	T	d	t			\$	4	D	T	d	t		
5	%	5	E	U	e	u			%	5	E	U	e	u		
6	&	6	F	V	f	v			&	6	F	V	f	v		
7	'	7	G	U	g	w			'	7	G	U	g	w		
8	(8	H	X	h	x			(8	H	X	h	x		
9)	9	I	Y	i	y)	9	I	Y	i	y		
A	*	:	J	Z	j	z			*	:	J	Z	j	z		
B	+	<	K	\	k	(+	<	K	\	k	(
C	,	<	L	\	l	(,	<	L	\	l	(
D	-	=	M]	m)			-	=	M]	m)		
E	.	>	N	^	n	~			.	>	N	^	n	~		
F	/	?	O	_	o	~			/	?	O	_	o	~		

GL(Graphics Left) GR(Graphics Right)

(SMM804)

No. 31 (31 / 36)
1985.5.20(Rev.11A)

APPENDIX A.

n = 4 : Sweden

	Shift In.								Shift Out							
	0	1	2	3	4	5	6	7	8	9	A	B	C	D	E	F
0																
1																
2																
3																
4																
5																
6																
7																
8																
9																
A																
B																
C																
D																
E																
F																

GL(Graphics Left) GR(Graphics Right)

n = 5 : Japan Roman

	Shift In.								Shift Out							
	0	1	2	3	4	5	6	7	8	9	A	B	C	D	E	F
0																
1																
2																
3																
4																
5																
6																
7																
8																
9																
A																
B																
C																
D																
E																
F																

GL(Graphics Left) GR(Graphics Right)

n = 6 : Japan Katakana

	Shift In.								Shift Out							
	0	1	2	3	4	5	6	7	8	9	A	B	C	D	E	F
0																
1																
2																
3																
4																
5																
6																
7																
8																
9																
A																
B																
C																
D																
E																
F																

GL(Graphics Left) GR(Graphics Right)

n = 7 : Germany

	Shift In.								Shift Out							
	0	1	2	3	4	5	6	7	8	9	A	B	C	D	E	F
0																
1																
2																
3																
4																
5																
6																
7																
8																
9																
A																
B																
C																
D																
E																
F																

GL(Graphics Left) GR(Graphics Right)

	Dec	Hex	Symbol	Function	Page
<ESC>	68	44	D	Reset current tabs and set up to 32 HT (horiz.tabs) 11 TABS may range up to maximum width for character and printer size. E.G. Maximum TAB for normal characters this printer is 80. Format: <ESC> "D" N1 N2 N3 ... NN 0. Terminate TAB sequence with zero	
<ESC>	69	45	E	Turns on emphasized mode. Can't mix with superscript, subscript, or compressed modes 18	
<ESC>	70	46	F	Turns off emphasized mode 18	
<ESC>	71	47	G	Turns on double strike mode 18	
<ESC>	72	48	H	Turns off double strike mode, superscript, and subscript modes 18	
<ESC>	74	4A	J	Sets line spacing to N/144 " for one line only and when received causes contents of buffer to print ... 15 Format: <ESC> "J" N, 1 <= N <= 127	
<ESC>	75	4B	K	Sets bit image mode to 480 dots per 8" line 24 Format: <ESC> "K" N1 N2, N1 and N2 determine line length. Line length = N1 + 256 N2. 0 <= N1 <= 255, 0 <= N2 <= 255.	
<ESC>	76	4C	L	Sets bit image mode to 960 dots per 8" line 25 Format: <ESC> "L" N1 N2, N1 and N2 determine line length. Line length = N1 + 256 N2 0 <= N1 <= 255, 0 <= N2 <= 255.	
<ESC>	77	4D	M	Sets Elite size (12 CPI) mode 21	
<ESC>	78	4E	N	Sets skip over perforation to N lines 14 Format: <ESC> "N" N, 1 <= N <= 127.	
<ESC>	79	4F	O	Resets skip over perforation to 0 lines 15	
<ESC>	80	50	P	Cancel Elite size (12 CPI) mode 21	
<ESC>	81	51	Q	Sets column width 12 Format: <ESC> "Q" N, 1 <= N <= maximum number (142) of characters/line.	
<ESC>	82	52	R	Set international characters 20 <ESC> "R" N, 0 <= N <= 11	
<ESC>	83	53	S	Sets superscript/subscript modes 19 Format: <ESC> "S" N, N=0 superscript, N=1 subscript	
<ESC>	84	54	T	Resets superscript, subscript, and unidirectional printing (does not turn off double strike from script modes) 19	
<ESC>	85	55	U	Unidirectional printing. Prints each line from left to right 22 Format: <ESC> "U" N, N=0 ---- OFF, N=1 ---- ON.	
<ESC>	87	57	W	Double width printing. Stays ON until turned OFF 19 Format: <ESC> "W" N, N=0 ---- OFF, N=1 ---- ON. Has precedence over Shift Out (SO=CHR\$(14)).	
<ESC>	89	59	Y	Sets dot graphics mode to 1280 dots per 8" line... 25 Format: <ESC> "Y" N1 N2, N1 and N2 determine line length. Line length = N1 + 256*N2. 0 <= N1 <= 255, 0 <= N2 <= 255.	
<ESC>	94	5E	^	Sets 9-pin bit image mode selection 25 Format: <ESC> "A" N1 N2, N=0, 480 dots/line bit image mode N=1, 960 dots/line bit image mode N=3, 1280 dots/line bit image mode 0 <= N1 <= 255, 0 <= N2 <= 255. n1 and n2 determine line length = n1 + n2 * 256	
<ESC>	108	6C	I	Sets left margin to n character columns 16 Format: <ESC> "I" N, For N, refer to ESC Q.	

APPENDIX C.

Dec. Hex.	Symbol	Function
127	7F	DEL Deletes last character in printer buffer.
128	80	NUL Follows <ESC> "D" as terminator for TABS
135	87	BEL Sounds buzzer for 1 second.
136	88	BS Backspace, empties printer buffer, then backspaces print head one space.
137	89	HT Horizontal Tabulation.
138	8A	LF Line Feed.
139	8B	VT Vertical Tabulation or single line feed.
140	8C	FF Advances paper to TOF (Top Of next Form).
141	8D	CR Carriage Return.
142	8E	SO Shift Out. Turns on double width. Turns OFF at end of line.
145	91	DC1 Sets printer to select (on-line)
143	8F	S1 Shift In. Turns on compressed character mode. Does not work with emphasized mode.
147	93	DC3 Sets printer deselect (off-line)
146	92	DC2 Turns off compressed characters.
148	94	DC4 Turns off double width mode. (Shift out only)
152	98	CAN Cancel
155	9B	ESC ASCII code for ESCAPE.
255	FF	DEL Deletes last character in printer buffer.

Note: Numbers flagged with a % may require the addition of 128 to make work reliable.
When in doubt, add 128.

MODEL SDM124
(Parallel Interface)

REVISION

Data	Page	Revised Parts
1985/1/9		ESC R n is added. Code Tables is changed.
1985/1/17	P1,2	Printing width is changed. 82 ch. → 80 ch. (10 pitch) 98 ch. → 96 ch. (12 pitch)
1985/2/21	P3	$\overline{\text{INT}}$ → $\overline{\text{INIT}}$
	P4	ESC 5 - Forward Print ON is renamed as "Backward Print OFF". ESC W is changed to ESC O. ESC /, ESC \, ESC [, ESC], ESC ", and ESC # are added. ESC R n is changed to ESC 3 n.
	P5	ESC 5 - Forward Print ON is renamed as "Backward Print OFF".
	P6,7	ESC /, ESC \, ESC [, ESC], ESC ", and ESC # are added. ESC W is changed to ESC O.
	P9	ESC R n is changed to ESC 3 n.
	P10	Pin NO. 18, NC → +5V OK
	P11	Note (3) is added. Circuit of PE is changed.
	P15	ESC R n is changed to ESC 3 n.
	P27	Interface Cable Specifications is added.

5/16 ESC SP ADDED
 DEL ADDED

Specifications

Type: Daisy wheel impact printer
Main body: Power supply, control board, printer mechanism, paper feed mechanism, carriage feed mechanism, control panel, operating levers, cover, frame

Daisy wheel: 96 characters
Printing speed: 10 cps (Shannon text with 10 pitch)
12 cps maximum
Print pitch: 10 ch./inch, 12 ch./inch
Carriage movement: 1/120 inch minimum
Printing direction: Bidirectional (Logic-seeking)
Carriage return: 1,200 ms/8 inches
Paper width: 11.8 inches (300 mm)
Printing width: 80 ch./line in 10 pitch
96 ch./line in 12 pitch

Copy capacity: 1 original + 3 copies
Paper feed speed: 2.5 inch/sec.
Line feed: 1/48 inches minimum (0.53 mm)
Interface: Centronics compatible parallel
Control panel: Switches: ON LINE, LINE FEED, TOF SET
Lamps: POWER, ON LINE

Alert sensors: Ribbon-end
Paper-end (when the form tractor or cut sheet feeder is in use.)

Operating levers: Paper release lever, paper bail lever
Ribbon: Multi-strike film ribbon (standard)
One-time film ribbon (option)
Fabric ribbon (option)

Options: Form tractor, cut sheet feeder
Power rating: 100V, 120V, 220V, 240V AC (50/60H)
Power consumption: 55W
Dimensions: 15.6(W) x 5.0(H) x 12.4(D) inches
398(W) x 128(H) x 316(D) mm
Weight: 15.4lbs. (7 kg)

Control Panel

A. Switches

1. ON LINE
Toggles the printer between the two states of ON LINE and OFF LINE.
2. LINE FEED
Causes a line feed (1/6 inch). This switch is not operational in the state of ON LINE or ALERT. Depression of this switch does not affect the counter inside the printer.
When the power switch is turned ON while LINE FEED switch is depressed, the printer performs self-test printing. It continues until the power is turned OFF.
3. TOF SET
Sets the top of form position.
This switch is not operational when the printer is in the ON LINE state or ALERT condition. When this switch is depressed, ON LINE lamp blinks on and off twice to indicate that the top of form is properly set.

B. Lamp

1. POWER
This lamp is lit when the power switch is turned ON.
2. ON LINE
This lamp is lit while the printer is ON LINE and extinguished in the OFF LINE state.
This lamp blinks on and off when the printer is in any of the following ALERT condition.
 - (1) When the ribbon is not installed or used up.
 - (2) When the paper is out while using form tractor or cut sheet feeder.
 - (3) When the movement of the daisy wheel is hindered by the entangled ribbon, etc. (The lamp does not light until printing of the current line is finished.)

DIP Switches

A. Print Pitch

Selects 10 or 12 pitch.

SW1 Print pitch
OFF: 10 pitch
ON : 12 pitch

B. Auto Line Feed

Selects whether the printer performs Line Feed after the execution of CR (ODH) or not.

SW2 Auto LF
OFF No
ON Yes

C. Page Length

Sets the length of the page

SW3 Page length
OFF 11 inches
ON 12 inches

D. Cut Sheet Feeder

This switch should be set to "ON" position when the cut sheet feeder is in use. Then the form length will be set to 15 inches. When the cut sheet feeder is not used, set to "OFF" position. The form length will be 11 inches or set to the value specified by the ESC FF n code.

OFF: Cut sheet feeder not used
ON : Cut sheet feeder in use

Note: The printer checks the DIP switch settings,

- when power is turned ON, or
- the printer is initialized by the input of ESC CR P or activation of INIT signal (interface connector pin No.31).

Control Codes

BS	Backspace
CR	Carriage Return
FF	Form Feed
HT	Horizontal Tab
LF	Line Feed
SP	Space
ESC 1	Sets Horizontal Tab at Current Position
ESC 2	Clears All Tab Stops
ESC 5	Backward Print OFF
ESC 6	Backward Print ON
ESC 8	Clears Individual Tab Stop
ESC 9	Sets Left Margin at Current Position
ESC D	Negative Half-Line Feed
ESC E	Underline Mode ON
ESC O	Bold Mode ON
ESC R	Underline Mode OFF
ESC U	Half-Line Feed
ESC Y	Prints the Character Under ASCII Code 20H
ESC Z	Prints the Character Under ASCII Code 7FH
ESC &	Bold Mode OFF
ESC /	Bidirectional Print ON
ESC \	Bidirectional Print OFF
ESC [Disable Paper Out Detect
ESC]	Enable Paper Out Detect
ESC "	Auto LF with CR Mode ON
ESC #	Auto LF with CR Mode OFF
ESC ESC	Treats as 1 ESC
ESC LF	Negative Line Feed
ESC CR P	Initializes the Printer
ESC FF n	Sets Form Length
ESC HT n	Absolute Horizontal Tab
ESC RS n	Sets Vertical Motion Index (VMI)
ESC US n	Sets Horizontal Motion Index (HMI)
ESC VT n	Absolute Vertical tab
ESC 3 n	Selects the Language

ESC SP Ignore spaces until non space.
DEL Delete last character in buffer.

- ESC " Auto LF with CR Mode ON - 1BH, 22H
After this code is input, the printer executes Carriage Return and Line Feed when CR code is input. This code overrides the setting of DIP switch SW2.
- ESC # Auto LF with CR Mode OFF - 1BH, 23H
This code cancels Auto LF with CR Mode (ESC "). This code overrides the setting of DIP switch SW2.
- ESC ESC Treats as 1 ESC
This code functions the same as one ESC.
- ESC LF Negative Line Feed - 1BH, 0AH
This code feeds the paper one line (1/48 inch x VMI) downward.
- ESC CR P Initializes the Printer - 1BH, 0DH, 50H
This code initializes the printer.
- ESC FF n Sets Form Length - 1BH, 0CH, n
This code sets the length of a page.

Page length = (n) x VMI x 1/48 inch

The value of n is input by ASCII characters and can be specified from 1 to 126.
This code also sets the Top of Form position at the current printing line.

(e.g.)

VMI	n	Page Length	Input by BASIC
8	48	8 inches	CHR\$(27);CHR\$(12);CHR\$(48);
8	90	15 inches	CHR\$(27);CHR\$(12);CHR\$(90);
12	48	12 inches	CHR\$(27);CHR\$(12);CHR\$(48);

- ESC HT n Absolute Horizontal Tab - 1BH, 09H, n
This code moves the carriage to any print position without presetting the tab stops. n can be specified up to 126.

(e.g.)

Position you wish to move the carriage	n	Input by BASIC
Print position 5	5	CHR\$(27);CHR\$(9);CHR\$(5);
Print position 50	50	CHR\$(27);CHR\$(9);CHR\$(50);
Print position 80	80	CHR\$(27);CHR\$(9);CHR\$(80);

• ESC VT n Absolute Vertical Tab - 1BH, 0BH, n
 This code feeds the paper to any of the first 126 lines on the page regardless of the current printing line.

(e.g.)

Line you wish to reach	n	Input by BASIC
Line No.5	5	CHR\$(27);CHR\$(11);CHR\$(5);
Line No.33	33	CHR\$(27);CHR\$(11);CHR\$(33);
Line No.50	50	CHR\$(27);CHR\$(11);CHR\$(50);

• ESC RS n Sets VMI - 1BH, 1EH, n
 This code is used to change Vertical Motion Index.

Line spacing = (n-1) x 1/48 inch

In the above formula, (n-1) is VMI.
 The value of n is input by ASCII characters and can be specified up to 126.
 For example, when you wish to set line spacing to 1/4 inches (4 lines per inch),

$$1/4 = (n-1) \times 1/48$$

Therefore, the value of "n" should be 13.

(e.g.)

Line spacing	VMI	n	Input by BASIC
1/12inch	45		CHR\$(27);CHR\$(30);CHR\$(5);
1/4 inch	12	13	CHR\$(27);CHR\$(30);CHR\$(13);
1/3 inch	16	17	CHR\$(27);CHR\$(30);CHR\$(17);

• ESC US n Sets HMI - 1BH, 1FH, n
 This code is used to change Horizontal Motion Index.

Print pitch = (n-1) x 1/120 inch

In the above formula, (n-1) is HMI.
 The value of n is input by ASCII characters and can be specified up to 126.

(e.g.)

Print pitch	HMI	n	Input by BASIC
1/15 inch	8	9	CHR\$(27);CHR\$(31);CHR\$(9);
1/12 inch	10	11	CHR\$(27);CHR\$(31);CHR\$(11);
1/10 inch	12	13	CHR\$(27);CHR\$(31);CHR\$(13);

- ESC 3 n Selects the Language - 1BH, 33H, n
Language can be selected by specifying the value of "n" according to the table below.

n	Language
0	U.K.
1	U.S.A.
2	Finland
3	Norway/Denmark
4	Sweden
7	Germany
8	French Canada
9	France
10	Italy
11	Spain

Note:

1. The type wheel of the selected language must be installed on the printer.
2. The Code Table of the each language is attached to the latter part of this Specifications.
3. The same code table and type wheels are used for the languages specified by the value of "n", 2 and 4.
4. When the power is turned ON, the value of "n" is set to 1.

ESC SP

~~XXXX~~

DEL

Specifications

Data transmission method: 8-bit parallel
 Synchronization: By externally supplied STROBE pulses
 Handshaking: By ACK or BUSY signal
 Logic level: TTL compatible

Interface connector

Plug: 57-30360 (Amphenol) or its equivalent
 It is recommended that interface cables be kept as short as possible.

Receptacle: (on printer side)
 Amphenol 57-40360 or its equivalent

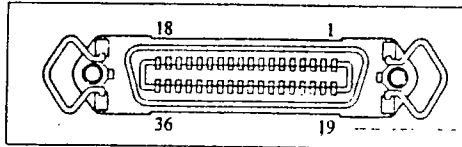

View on receptacle from connector cable side.

Connector pin assignment and signal descriptions

PIN NO.	SIGNAL	IN/OUT	SIGNAL DESCRIPTION
1	STROBE	IN	STROBE pulse to read data in. Pulse width must be more than 0.5μs when received at the printer. Normally "HIGH". When "LOW", the printer reads the data on the data bus.
2	DATA 1	IN	These signals represent the 1st(LSB) to 7th(MSB) bits of the parallel ASCII-coded data.
3	DATA 2	IN	
4	DATA 3	IN	
5	DATA 4	IN	
6	DATA 5	IN	
7	DATA 6	IN	
8	DATA 7	IN	
9	DATA 8	IN	
10	ACK	OUT	A pulse of approx. 10μs. Normally "HIGH". "LOW" indicates the printer has received data and is ready to accept next data.
11	BUSY	OUT	"HIGH" indicates that the printer cannot accept data. This signal goes "HIGH" in the following cases: 1. During data entry 2. Print buffer becomes full. 3. Printer error occurs.
12	PE	OUT	This signal goes "HIGH" when the paper-end (When the form tractor or cut sheet feeder is in use.) or ribbon-end is detected.
13	SLCT	OUT	Always "HIGH". The printer is always selected by the host unit.
14	AUTO FEED XT	IN	When "LOW", the printer performs carriage return and line feed when it receives CR code.
15	NC	—	Not used.
16	GND	OUT	Signal Ground level
17	NC	—	Not used.
18	+5V	OUT	+5V
19 to 30	GND	OUT	Twisted-Pair Return Signal Ground

OK

PIN NO.	SIGNAL	IN/OUT	SIGNAL DESCRIPTION
31	INIT	IN	When "LOW", this signal resets the printer to its initial state. Pulse width must be more than 50µs when received by the printer.
32	ERROR	OUT	This signal goes "LOW" in the following cases: 1. In the state of "OFF-LINE" 2. End of ribbon 3. When the movement of daisy wheel is hindered in some way. For example, the wheel gets entangled with the ribbon. (<u>ERROR</u> signal will not be sent until printing of the current line is completed.)
33	GND	OUT	Signal Ground level
34	NC	—	Not used.
35	FUSE	OUT	Pulled up to +5V through resistance.
36	NC	—	Not used.

NOTES:

- * "RETURN" denotes "TWISTED PAIR RETURN" and is to be connected at signal ground level.
- As to the wiring for the interface, be sure to use a twisted-pair cable for each signal and never fail to complete connection on the Return side. To prevent noise effectively, these cables should be shielded and connected to the chassis of the host computer and the printer respectively.
- * Data transfer must not be carried out by ignoring the ACK or BUSY signal.
- *Up to 100mA can be drawn from Pin No.18.

Input/Output circuits

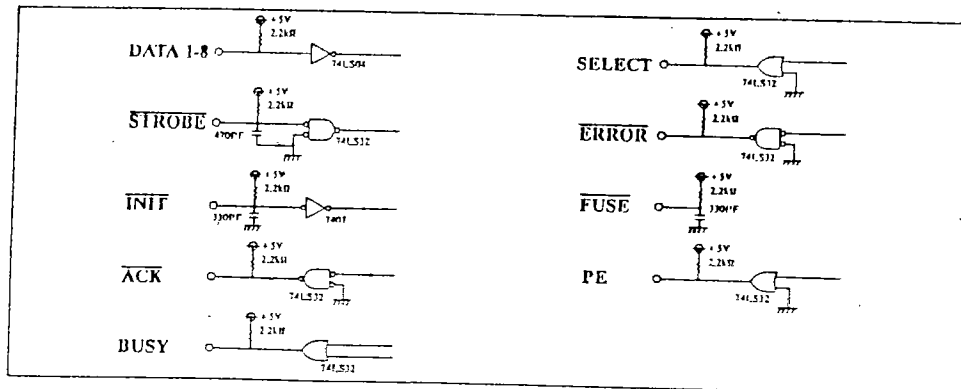

Timing chart

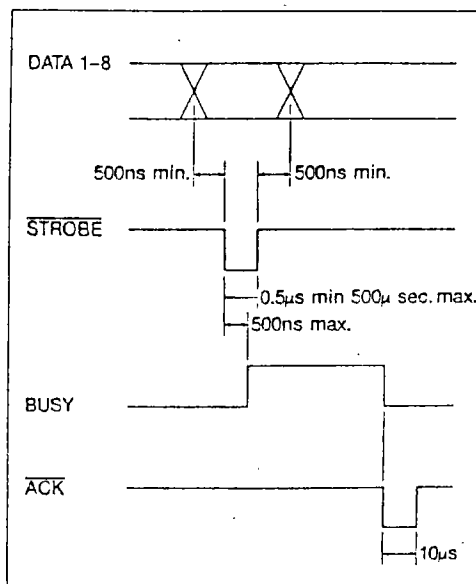

Reset of the Printer

A. The printer is initialized in any of the following cases:

- (1) When the power switch is turned ON.
- (2) When the printer receives INIT signal.
- (3) When the printer receives ESC CR P code.

B. The condition of the printer when initialized is as follows:

- (1) The carriage returns to the horizontal position 0.
- (2) The printing direction is forward.
- (3) Top of Form is set at the position of the carriage.
- (4) The line spacing is set at 1/6 inch (VMI=8).
- (5) Auto underline mode OFF.
- (6) Bold printing mode OFF
- (7) The condition of the DIP switches is read.

SW1 Print pitch
SW2 Page length
SW3 Auto line feed
SW4 Cut sheet feeder

Print Format

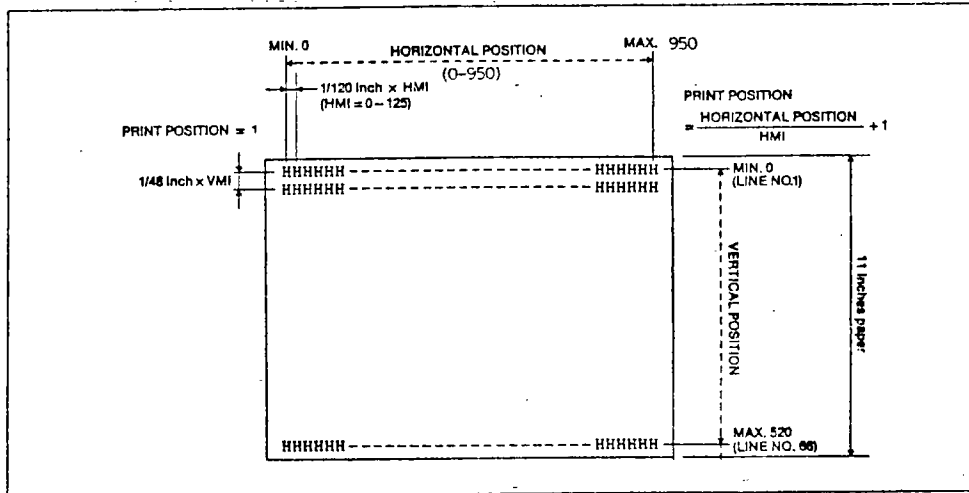

(1) Horizontal Motion Index (HMI)

Following the printing of a character or a space, the carriage moves by $1/120$ inch \times HMI. HMI represents Horizontal Motion Index and is variable from a minimum of 0 (no spacing) to a maximum of 125 ($125/120 = 1.04$ inch)

HORIZONTAL SPACING		
HMI	Ch./inch	Max. ch. per line
12	10	80
10	12	96

(2) Vertical Motion Index (VMI)

A line feed causes the paper to move by $1/48$ inch \times VMI. VMI represents Vertical Motion Index and is variable from a minimum of 0 to a maximum of 125.

(3) Horizontal Position

This is the value which represents the distance between the printhead and left final stop in $1/120$ inch increments, ranging from a minimum of 0 to a maximum of 950 ($1/120$ inch \times 950 \approx 8 inches).

(4) Vertical Position

This is the value which represents the distance between the current printing line and the designated first line in the corresponding page in $1/48$ inch increments, ranging from a minimum of 0 to a maximum of 520 (11 inches paper).

(5) Print Position

The print position is indicated by the number calculated from the maximum left margin setting (the position the carriage goes upon power-on) to the present position of the carriage taking into consideration the pitch selected, according to the following formula:

$$\text{Print Position} = \frac{\text{Horizontal Position}}{\text{HMI}} + 1$$

The maximum left margin is always considered as position 1 and therefore the maximum print position in 10 pitch, (HMI = 12) is:

$$(950/12 + 1) \div 80$$

(6) Line Number

The line number is indicated by the number calculated from the first line of the page, to the present position of the carriage, taking into consideration the line feed spacing selected. The line number, there, can be calculated as follows:

$$\text{Line Number} = \frac{\text{Vertical Position}}{\text{VMI}} + 1$$

For example, when using the standard (the default value upon power-on) 6 lines per inch spacing (VMI = 8) on 11 inches paper, the maximum number of lines would be:

$$(520/8 + 1) = 66$$

Type Wheel

The following table shows the type wheels available for the Atari SDM124. The type wheel must be installed in accordance with the language selected by the ESC 3 n.

Pitch	Type Style	ESC R n									
		0	1	2/4	3	7	8	9	10	11	
10P	COURIER 10	6441	6421	6471	6461	6431	6171	6451	6131	6051	
	PRESTIGE PICA		6821				6737		6733	6725	
	ORATOR		6321						6135	6055	
	OCR-B		6341								
12P	COURIER 12	6442	6422	6472	6462	6432	6172	6452	6132	6052	
	PRESTIGE ELITE		6841								
	LETTER GOTHIC		6301						6136	6056	
	SCRIPT		6861								

Note:

1. The same type wheels and code table is used when the value of "n" is 2 and 4.
2. The "n" corresponds to the language as follows;

- 0: U.K.
- 1: U.S.A.
- 2: Finland
- 3: Norway/Denmark
- 4: Sweden
- 7: Germany
- 8: French Canada
- 9: France
- 10: Italy
- 11: Spain

Packing List

Daisy wheel	1
Ribbon (Multi-strike)	1
Operating Manual	1
Interface Cable	1 (@¥1,970.-)

Power Code Plugs .

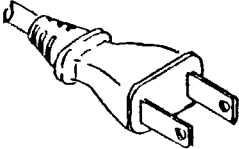
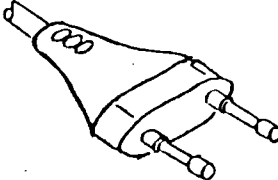
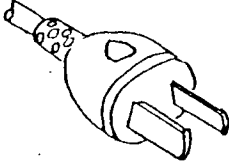
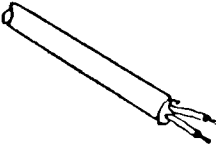
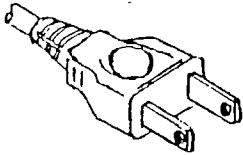
A. UL/CSA CORD	B. CEE CORD
 A line drawing of a UL/CSA cord plug, showing a rectangular body with two flat, parallel prongs extending from the front.	 A line drawing of a CEE cord plug, featuring a rounded, bell-shaped body with two cylindrical pins protruding from the front.
C. SAA CORD	D. BSI CORD (NO PLUG)
 A line drawing of a SAA cord plug, which has a circular body with two rectangular prongs extending from the front.	 A line drawing of a BSI cord without a plug, showing a cylindrical cable with three individual wires protruding from the end.
E. JIS CORD	
 A line drawing of a JIS cord plug, showing a rectangular body with two flat prongs and a circular grounding hole on the top surface.	

Code Tables

U.K. (ESC R 0)

					b8	0	0	0	0	0	0	0	0	0
					b7	0	0	0	0	1	1	1	1	
					b6	0	0	1	1	0	0	1	1	
					b5	0	1	0	1	0	1	0	1	
b4	b3	b2	b1		0	1	2	3	4	5	6	7		
0	0	0	0	0				0	e	P	-	p		
0	0	0	1	1			!	1	A	Q	a	q		
0	0	1	0	2			"	2	B	R	b	r		
0	0	1	1	3			E	3	C	S	c	s		
0	1	0	0	4			\$	4	D	T	d	t		
0	1	0	1	5			%	5	E	U	e	u		
0	1	1	0	6			&	6	F	V	f	v		
0	1	1	1	7			'	7	G	W	g	w		
1	0	0	0	8			(8	H	X	h	x		
1	0	0	1	9)	9	I	Y	i	y		
1	0	1	0	A			*	:	J	Z	j	z		
1	0	1	1	B			+	;	K	[k	{		
1	1	0	0	C			,	<	L	\	l			
1	1	0	1	D			-	=	M]	m	}		
1	1	1	0	E			.	>	N	~	n	~		
1	1	1	1	F			/	?	O	_	o			

ESC Y

ESC Z

1501

U.S.A. (ESC R 1)

					b8	0	0	0	0	0	0	0	0
					b7	0	0	0	0	1	1	1	1
					b6	0	0	1	1	0	0	1	1
					b5	0	1	0	1	0	1	0	1
b4	b3	b2	b1			0	1	2	3	4	5	6	7
0	0	0	0	0				0	e	P	~	P	
0	0	0	1	1			l	1	A	Q	a	q	
0	0	1	0	2			"	2	B	R	b	r	
0	0	1	1	3			#	3	C	S	c	s	
0	1	0	0	4			\$	4	D	T	d	t	
0	1	0	1	5			%	5	E	U	e	u	
0	1	1	0	6			&	6	F	V	f	v	
0	1	1	1	7			'	7	G	W	g	w	
1	0	0	0	8			(8	H	X	h	x	
1	0	0	1	9)	9	I	Y	i	y	
1	0	1	0	A			*	:	J	Z	j	z	
1	0	1	1	B			+	;	K	[k	[
1	1	0	0	C			,	<	L	\	l		
1	1	0	1	D			-	=	M]	m]	
1	1	1	0	E			.	>	N	^	n	-	
1	1	1	1	F			/	?	O	_	o		

ESC Y ♂ ESC Z ♀

Finland, Sweden (ESC R 2, ESC R 4)

					b8	0	0	0	0	0	0	0	0	0
					b7	0	0	0	0	1	1	1	1	
					b6	0	0	1	1	0	0	1	1	
					b5	0	1	0	1	0	1	0	1	
b4	b3	b2	b1			0	1	2	3	4	5	6	7	
0	0	0	0	0				0	É	P	é	p		
0	0	0	1	1			l	1	A	Q	a	q		
0	0	1	0	2			"	2	B	R	b	r		
0	0	1	1	3			#	3	C	S	c	s		
0	1	0	0	4			□	4	D	T	d	t		
0	1	0	1	5			&	5	E	U	e	u		
0	1	1	0	6			&	6	F	V	f	v		
0	1	1	1	7			'	7	G	W	g	w		
1	0	0	0	8			(8	H	X	h	x		
1	0	0	1	9)	9	I	Y	i	y		
1	0	1	0	A			*	:	J	Z	j	z		
1	0	1	1	B			+	;	K	Å	k	å		
1	1	0	0	C			,	<	L	Ö	l	ö		
1	1	0	1	D			-	=	M	Ä	m	ä		
1	1	1	0	E			.	>	N	Ü	n	ü		
1	1	1	1	F			/	?	O	—	o			

ESC Y E ESC Z §

Norway/Denmark (ESC R 3)

					b8	0	0	0	0	0	0	0	0
					b7	0	0	0	0	1	1	1	1
					b6	0	0	1	1	0	0	1	1
					b5	0	1	0	1	0	1	0	1
b4	b3	b2	b1			0	1	2	3	4	5	6	7
0	0	0	0	0				0	e	p			p
0	0	0	1	1			!	1	A	Q	a		q
0	0	1	0	2			"	2	B	R	b		r
0	0	1	1	3			\$	3	C	S	c		s
0	1	0	0	4			\$	4	D	T	d		t
0	1	0	1	5			&	5	E	U	e		u
0	1	1	0	6			&	6	F	V	f		v
0	1	1	1	7			'	7	G	W	g		w
1	0	0	0	8			(8	H	X	h		x
1	0	0	1	9)	9	I	Y	i		y
1	0	1	0	A			*	:	J	Z	j		z
1	0	1	1	B			+	;	K	Æ	k		æ
1	1	0	0	C			,	<	L	Ø	l		ø
1	1	0	1	D			-	=	M	Å	m		å
1	1	1	0	E			.	>	N	Ů	n		ů
1	1	1	1	F			/	?	O	—	o		

ESC Y E ESC Z |

Germany (ESC R 7)

					b8	0	0	0	0	0	0	0	0	0
					b7	0	0	0	0	1	1	1	1	
					b6	0	0	1	1	0	0	1	1	
					b5	0	1	0	1	0	1	0	1	
					b4	b3	b2	b1	0	1	2	3	4	5
0	0	0	0	0			0	\$	P	~	p			
0	0	0	1	1			!	1	A	Q	a	q		
0	0	1	0	2			"	2	B	R	b	r		
0	0	1	1	3			#	3	C	S	c	s		
0	1	0	0	4			\$	4	D	T	d	t		
0	1	0	1	5			%	5	E	U	e	u		
0	1	1	0	6			&	6	F	V	f	v		
0	1	1	1	7			'	7	G	W	g	w		
1	0	0	0	8			(8	H	X	h	x		
1	0	0	1	9)	9	I	Y	i	y		
1	0	1	0	A			*	:	J	Z	j	z		
1	0	1	1	B			+	;	K	X	k	ñ		
1	1	0	0	C			,	<	L	O	l	ø		
1	1	0	1	D			-	=	M	U	m	u		
1	1	1	0	E			.	>	N	^	n	ß		
1	1	1	1	F			/	?	O	_	o			

ESC Y €

ESC Z ~

French Canada (ESC R 8)

					b8	0	0	0	0	0	0	0	0	0
					b7	0	0	0	0	1	1	1	1	
					b6	0	0	1	1	0	0	1	1	
					b5	0	1	0	1	0	1	0	1	
b4	b3	b2	b1		0	1	2	3	4	5	6	7		
0	0	0	0	0				0	e	P		p		
0	0	0	1	1			l	1	A	Q	a	q		
0	0	1	0	2			"	2	B	R	b	r		
0	0	1	1	3			#	3	C	S	c	s		
0	1	0	0	4			\$	4	D	T	d	t		
0	1	0	1	5			%	5	E	U	e	u		
0	1	1	0	6			&	6	F	V	f	v		
0	1	1	1	7			'	7	G	W	g	w		
1	0	0	0	8			{	8	H	X	h	x		
1	0	0	1	9			}	9	I	Y	i	y		
1	0	1	0	A			*	:	J	Z	j	z		
1	0	1	1	B			+	;	K	[k	é		
1	1	0	0	C			,	-	L	,	l			
1	1	0	1	D			-	=	M]	m	"		
1	1	1	0	E			.	`	N	-	n	~		
1	1	1	1	F			/	?	O	_	o			

ESC Y ¢

ESC Z •

France (ESC R 9)

					b8	0	0	0	0	0	0	0	0
					b7	0	0	0	0	1	1	1	1
					b6	0	0	1	1	0	0	1	1
					b5	0	1	0	1	0	1	0	1
b4	b3	b2	b1		0	1	2	3	4	5	6	7	
0	0	0	0	0				0	à	P		p	
0	0	0	1	1			!	1	A	Q	a	q	
0	0	1	0	2			"	2	B	R	b	r	
0	0	1	1	3			£	3	C	S	c	s	
0	1	0	0	4			\$	4	D	T	d	t	
0	1	0	1	5			§	5	E	U	e	u	
0	1	1	0	6			&	6	F	V	f	v	
0	1	1	1	7			'	7	G	W	g	w	
1	0	0	0	8			(8	H	X	h	x	
1	0	0	1	9)	9	I	Y	i	y	
1	0	1	0	A			*	:	J	Z	j	z	
1	0	1	1	B			+	;	K	•	k	é	
1	1	0	0	C			,	<	L	ç	l	ù	
1	1	0	1	D			-	=	M	š	m	è	
1	1	1	0	E			.	>	N	ˆ	n	ˆ	
1	1	1	1	F			/	?	O	˘	o	˘	

ESC Y R

ESC Z

Italy (ESC R 10)

					b8	0	0	0	0	0	0	0	0	0
					b7	0	0	0	0	1	1	1	1	
					b6	0	0	1	1	0	0	1	1	
					b5	0	1	0	1	0	1	0	1	
b4	b3	b2	b1			0	1	2	3	4	5	6	7	
0	0	0	0	0					0	Ç	P	Ù	P	
0	0	0	1	1			!	1	A	Q	a	q		
0	0	1	0	2			"	2	B	R	b	r		
0	0	1	1	3			£	3	C	S	c	s		
0	1	0	0	4			\$	4	D	T	d	t		
0	1	0	1	5			§	5	E	Ü	e	u		
0	1	1	0	6			&	6	F	V	f	v		
0	1	1	1	7			'	7	G	W	g	w		
1	0	0	0	8			(8	H	X	h	x		
1	0	0	1	9)	9	I	Y	i	y		
1	0	1	0	A			*	:	J	Z	j	z		
1	0	1	1	B			+	;	K	°	k	ä		
1	1	0	0	C			,	<	L	é	l	ö		
1	1	0	1	D			-	=	M		m	è		
1	1	1	0	E			.	>	N	~	n	ï		
1	1	1	1	F			/	?	O	_	o			

ESC Y "

ESC Z ¼

Spain (ESC R 11)

					b8	0	0	0	0	0	0	0	0	0
					b7	0	0	0	0	1	1	1	1	
					b6	0	0	1	1	0	0	1	1	
					b5	0	1	0	1	0	1	0	1	
b4	b3	b2	b1		0	1	2	3	4	5	6	7		
0	0	0	0	0				0	~	P	~	p		
0	0	0	1	1			!	1	A	Q	a	q		
0	0	1	0	2			"	2	B	R	b	r		
0	0	1	1	3			£	3	C	S	c	s		
0	1	0	0	4			\$	4	D	T	d	t		
0	1	0	1	5			&	5	E	U	e	u		
0	1	1	0	6			&	6	F	V	f	v		
0	1	1	1	7			'	7	G	W	g	w		
1	0	0	0	8			(8	H	X	h	x		
1	0	0	1	9)	9	I	Y	i	y		
1	0	1	0	A			*	:	J	Z	j	z		
1	0	1	1	B			+	;	K	I	k	a		
1	1	0	0	C			,	o	L	N	l	n		
1	1	0	1	D			-	=	M	z	m	ç		
1	1	1	0	E			.	o	N	^	n	h		
1	1	1	1	F			/	?	O	_	o			

ESC Y "

ESC Z |