

**SERVICE
MANUAL**

TTM195

19" MONOCHROME MONITOR

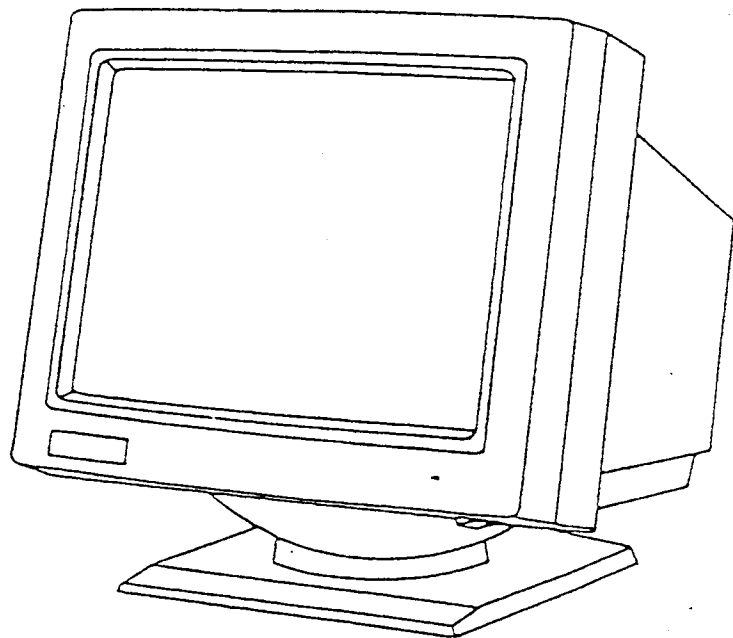

TITLE

SERVICE MANUAL
MODEL: M19P114P/7103

PART NO.

5107 991 05491

SHEET

2

OF

79

SECTIONCONTENTS

- 1 Safety Precautions and Hi-Pot Testing
- 2 Specifications
- 3 Timing Diagram and Signal Input Connections
- 4 User and Service Control Locations, Service and Alignment Procedure
- 5 Block Diagram
- 6 Trouble Shooting Charts
- 7 Current and Voltage Waveforms
- 8 Theory of Operation
- 9 Schematic Diagrams and Service Prints
- 10 Semiconductor Lead Identification
- 11 Exploded View and Packing Diagram
- 12 Replacement Parts List

REV

TITLE

SERVICE MANUAL
MODEL: M19P114P/7103

PART NO.

5107 991 05491

SHEET 3 OF 79

SECTION 1

SAFETY PRECAUTIONS

Product Safety Notice

For the continued safe operation of this monitor, it is imperative that the components shown in the shaded areas of the various electrical schematics included in this manual be replaced only with those specified in the manual's parts lists. The use of substitute replacement parts that do not have the same safety characteristics as those specified may create shock, fire X-radiation and other hazards.

All other electrical or mechanical parts must be replaced by those having identical specifications as determined from the parts lists. Potentiometers must be resealed with approved sealant after service adjustment or replacement. Under no circumstances may the original design be modified or altered without written permission from Philips Electronics Ltd., 601 Milner Avenue, Scarborough, Ontario. M1B 1M8.

X-Radiation Warning

When replacing the CRT or any other components in this monitor, use only a designated replacement part present on the bill of material. Many components are "safety critical components" and must be replaced with approved parts to ensure this monitor will comply with the safety agencies X-ray emission limits.

Personal Safety Precautions

Notice: Observe all cautions and safety related notes located inside the monitor chassis and on the CRT.

WARNING

1. Operation of this monitor with the rear cover and safety screens removed can expose the operator to a shock hazard. Only qualified service personnel should attempt to repair this monitor. Service personnel must read all the following precautions before starting repairs on this monitor.
2. The following safety precautions must be observed when working on this monitor:
 - a) To reduce the possibility of an electric shock or burn, remove all rings, wristwatches, bracelets, necklaces and other jewelry before attempting to repair this monitor.
 - b) Before reaching inside the monitor to remove modules or cable assemblies, always turn off the AC power switch and disconnect the AC line cord from the back of the monitor.

REV

- c) The CRT should always be discharged before reaching into the monitor. The flyback transformer in this monitor has an internal bleeder resistor that will discharge the CRT after the AC power is removed. But if this resistor should fail, the anode will remain charged at 20kV.

If the anode connector is removed from the CRT during repairs, the CRT should again be discharged before reassembly as a charge can build up on the CRT anode during the repair time.

- d) The AC line cord that is included with this monitor has a safety ground and must always be connected to a ground outlet. Never use an adaptor plug to connect the monitor's three-prong AC power plug to a two-prong wall outlet.
- e) Never use a grounding wriststrap, heelstrap or work on a grounded workbench when discharging the CRT or when performing adjustments on an operating monitor. These ground straps should only be worn when working on modules outside of the monitor.
- f) When handling the CRT, eye protection should always be worn. The CRT should always be carried with two hands firmly holding the CRT face plate and metal rim band. Never pick up or handle the CRT by its neck. The CRT in this monitor weighs approximately 11.4kg.

Safety Check-Out

Before the Atari Monochrome Monitor is returned to the customer after servicing, both the following safety checks are required:

Hi-Pot Test

The Hi-Pot test is performed to check the insulation resistance between the AC line terminals of the input and chassis ground.

Equipment Required:

- 1) Hi-Pot tester, ROD-L M100 or equivalent.

Procedure:

NOTE: The high voltage must be increased and decreased gradually during the test. The ramp-up and ramp-down rate must be set to 500 volts/second maximum.

- 1) Unplug the Atari Monochrome Monitor from the AC mains.
- 2) Turn the ON/OFF switch to the "ON" position.
- 3) Plug the AC line cord from the Atari Monochrome Monitor into the Hi-Pot tester.
- 4) Connect the "Chassis Ground" clamp off the Hi-Pot tester to the chassis of the monitor.

- 5) Turn on the Hi-Pot tester.
- 6) The green pilot "ready" light must be illuminated otherwise the grounding connection between the monitor and the Hi-Pot tester is not properly done.
- 7) Press the "Start" button on the Hi-Pot Tester. The Orange "Testing" light must be illuminated. The monitor must be tested at a maximum Hi-Pot Tester. The Orange "Testing" light must be illuminated. The monitor must be tested at a maximum Hi-Pot voltage of 1500Vrms for 1 to 2 seconds. The maximum leakage current allowed during this test is 10mA.
- 8) If the red "fault" light comes on during the test, there may be a fault with the monitor. The test can be repeated after a 10 second wait. If the red fault light comes on again, the monitor must be repaired as there is a problem with the insulation between the AC line terminals and chassis ground.
- 9) Turn off the Hi-Pot tester.
- 10) Unplug the monitor from the Hi-Pot tester.
- 11) Disconnect the "Chassis Ground" clamp from the chassis.

Ground Continuity Test

Equipment Required:

- 1) An AC source capable of 12 Vac maximum (open circuited) and 25 Amps continuous current (current limited) with a built-in Ammeter.
- 2) A Digital Volt Meter (DVM) if the AC source does not have a built-in voltmeter.

Procedure:

- 1) Connect the AC source between these two contact points:
 - a) The ground pin of the AC input connector.
 - b) The ground shell of the input signal connector.
- 2) Turn the supply on.
- 3) Measure and record the voltage drop between these two points on the DVM.
- 4) Measure and record the current flowing between the two contact points.
- 5) Turn off the AC source.

TITLE

SERVICE MANUAL
MODEL: M19P114P/7103

PART NO.

5107 991 05491

SHEET 6 OF 79

- 6) Calculate the resistance between the two contact points.
It must not exceed 0.1 ohms.
- 7) Repeat the above test with the AC source connected between:
 - a) The ground pin of the AC input connector.
 - b) The chassis of the monitor.

The calculated resistance must not exceed 0.1 ohms.

NOTE:

If either of the tests indicate a resistance of over 0.1 ohms, the monitor fails the Ground Continuity test and must be repaired. The most likely fault is a disconnected or loose wire between the video board or the EMI line filter and the grounding stud on the rear panel. Also check that the grounding stud is securely mounted and all lock nuts on the stud are tight.

REV

TITLE

SERVICE MANUAL
MODEL: M19P114P/7103

PART NO.

5107 991 05491

SHEET

7

OF

79

SECTION 2SPECIFICATIONS

Type	20" Monochrome Display Monitor.
Picture Tube	20", 114° Deflection Angle. Medium Short Persistence Phosphor. (White) Antiglare Mechanical Etched. Type, Philips M47EAA7WJL (with ISL).
Power Connector	IEC 3 Pin Male
Input Voltage	90-270 Vac.
Input Frequency	47-63Hz.
Input Power	100 Watts Maximum.
Signal Connector	98-9
Input Signal Video	Balanced ECL 1bit 120 ohm Impedence
Sync	Separate TTL Level
Polarity	Negative H. and V.
Impedence	(TTL Gate)
Frequency Video	128.85 MHz.
Frequency H. Sync	71.911 KHz.
Frequency V. Sync	71.624 Hz.
Video Size	Horizontal 335mm ± 4mm Vertical 251mm ± 4mm
Unit Dimensions	464H x 462W x 391L mm
Weight	19.5 Kg
Operating Temperature	+10°C + 40°C Ambient
Humidity	10% to 95% Non Condensing
Storage Temperature and Humidity	-40 to + 70°C Ambient Humidity 5% to 95% Non Condensing

REV

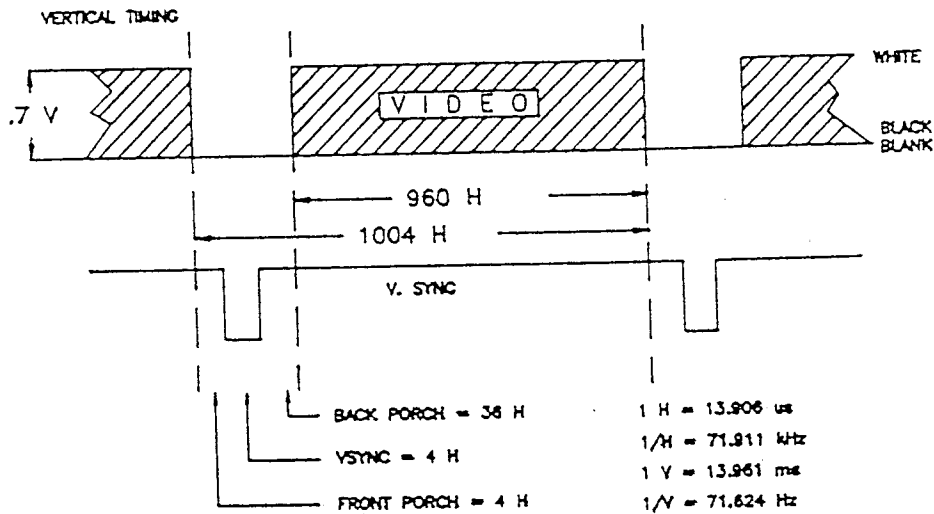
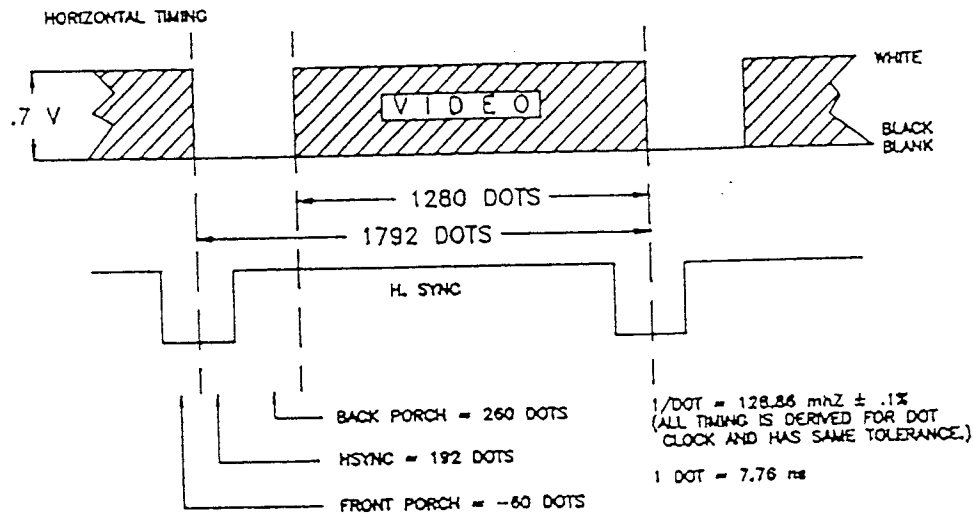

HORIZONTAL SYNC DETAIL



VERTICAL SYNC DETAIL



NO SYNC ON VIDEO. H AND V SYNC ARE TTL COMPATIBLE SIGNALS.

AS VIEWED FROM REAR OF MONITOR
9 PIN D CONNECTOR

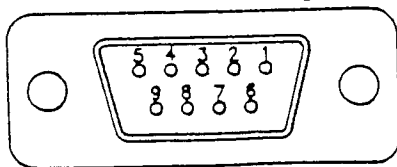

PIN NO.

- 1
- 2
- 3
- 4
- 5
- 6
- 7
- 8
- 9

FUNCTION

- +ECL VIDEO
- +ECL RET.
- H. SYNC
- V. SYNC
- GND. (NOT USED)
- ECL VIDEO
- ECL RET.
- SYNC RET.
- GND. (NOT USED)

REV

SECTION 3TIMING

Horizontal Frequency	71.911	kHz
Horizontal Period	13.906	uSec
Horizontal Blanking	3.973	uSec
Horizontal Sync Pulse	1.489	uSec
Horizontal Front Porch	-0.465	uSec
Active Horizontal Line Time	9.932	uSec
Vertical Frequency	71.624	Hz
Vertical Period	13.961	mSec
Vertical Blanking	611.86	uSec
Vertical Sync Width	55.624	uSec
Vertical Front Porch	55.624	uSec
Vertical Back Porch	500.612	uSec
Active Vertical Frame Time	13.349	mSec
Dot Rate	128.86	MHz
Dot Period	7.760	nSec
Total Pixels	1792	Pixels
Total Lines	1004	Lines

Active Pixels - Actual	1280	Pixels
Active Lines - Actual	960	Lines
D.P.I.	97	

Video Type: Balanced ECL 1 Bit @ 120 L - L
 Sync. Type: Separate TTL
 H. Sync Polarity: Negative
 V. Sync Polarity: Negative
 Model Type: M19P114P/7103/20
 Notes:

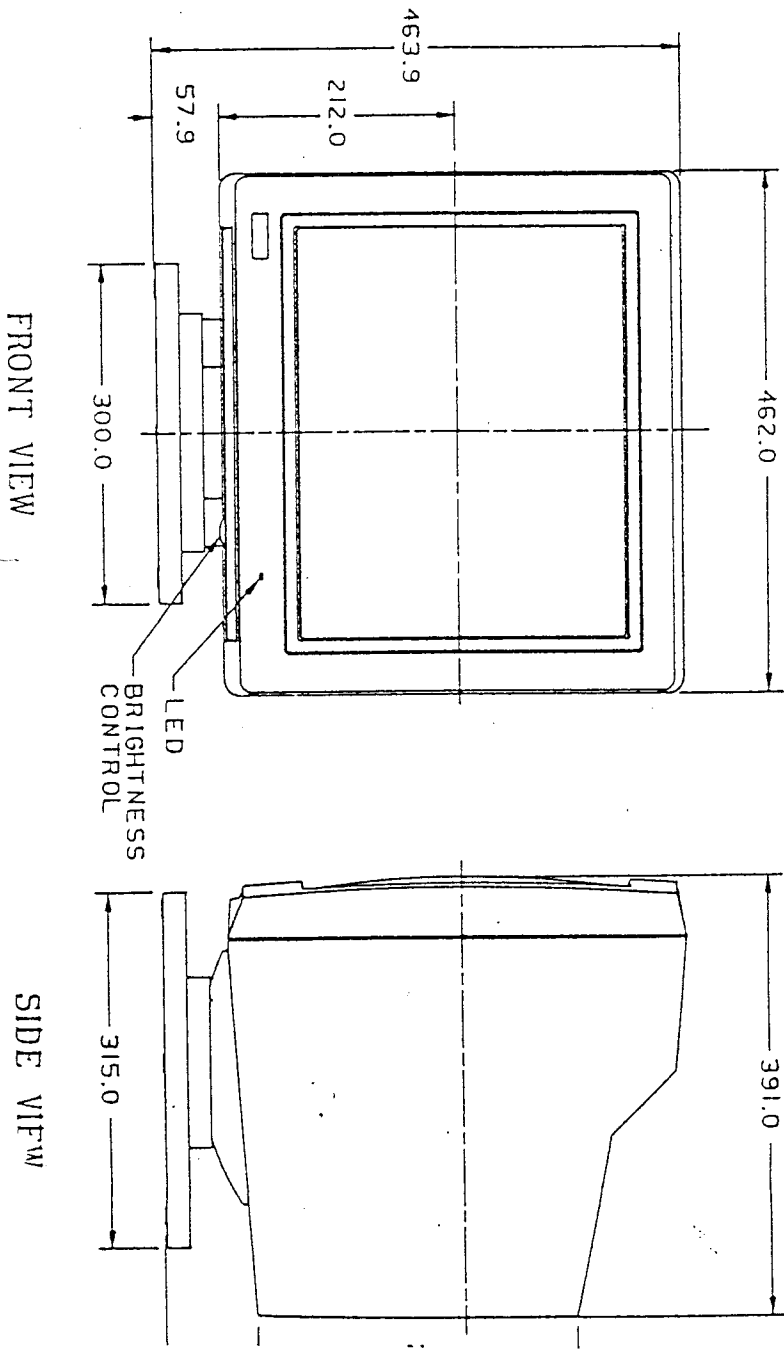

.3 Pretest Verification

Prior to proceeding, verify the following conditions. Any units failing this stage must be returned for repair.

Vert. Freq: With the unit unsynchronized, connect a frequency counter to TP302, and adjust R335 for a reading of 65Hz $\pm 2/-1$ Hz.

EHT: Connect the signal and select the all black pattern. EHT to be measured 20kV ± 1.3 kV.

Hor. Freq: Select all white pattern, connect voltmeter to IC201, Pin 6, and adjust R230 for a reading of 6.5VDC.

3 Raster Centering: Horizontal

Pre-adjust brightness to approximately 15FL with raster visible. Video must be centered in raster (R229) such that left hand visible raster is equal to or 2mm larger than right hand visible raster (see Fig. 4.3.1.4). The width control may be adjusted to bring the raster edges just within the bezel opening.

. 4.3.1.4

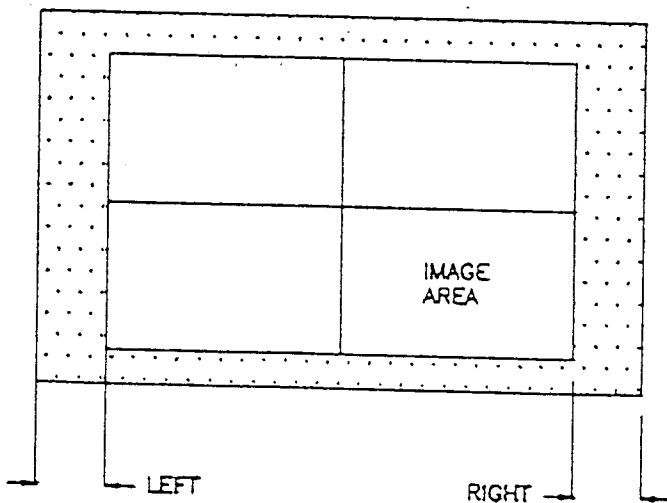

Start with circular magnets (centering magnets) in neutral position i.e. slotted ear of one magnet aligned with plain ear of other magnet, both positioned so that the ears are in the horizontal position of raster. Adjust magnets simultaneously and in opposite directions so as to avoid bending horizontal lines and centering active image within bezel gauge. (see Fig. 4.3.1.6).

Raster Centering; Vertical

Adjust vertical position of center line with vertical position control R333.

This should center horizontally and vertically a cross hair target pattern such that center lines are within the target windows of Fig. 4.3.1.6 The vertical center line shall be at $90^\circ \pm 0.5$ to the horizontal center line within a 2" radius of screen center.

4.3.1.5 Linearity and S-Correction

- a) With a cross-hatch pattern applied adjust R312 (overall Vert. Lin), R333 (vertical shift) and R329 (Height) to obtain uniform block sizes and active video centered in bezel gauge.

The width (L202) and horizontal linearity (L203) coils are interactive. L203 should first be adjusted to obtain maximum width, then turned slowly from that position until the left half of the picture is the same size as the right half. Adjust L202 to obtain the correct width, and verify that the left and right picture halves remain of equal size. Slight adjustment of the width control will not require readjustment of the linearity coil.

- b) Adjust L205 (H.F. S correction) to obtain smallest 3-rd harmonic horizontal linearity distortion. Default position of L205 is such that $V = 6.0 V_{pp}$ (measured during active video time only - see picture).

NOTE: Please do not exceed $V=10V_{pp}$ when setting L205.

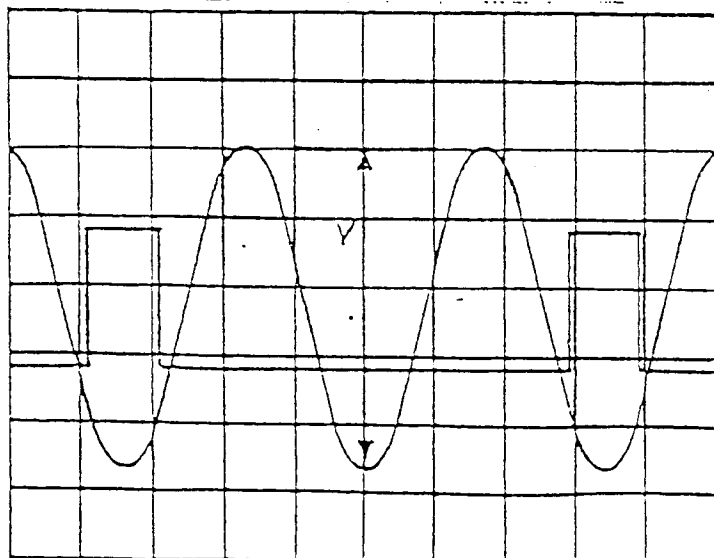

2 Trace 1 - CRT cathode voltage
(full white field)

1 Trace 2 - Test point 1 voltage
with respect to
Ground.

NOTE: The adjustment must be done introducing the slug of L205 into the coilform from the preset position.
L205 may require re-adjustment to obtain best linearity, and test point 1 voltage could then be anywhere between 3 - 10V.

c) Verify the horizontal raster centering as in Paragraph 4.3.1.4.

4.3.1.6 Video Size and Geometry

a) Make iterative adjustments as per 4.3.1.4 and 4.3.1.5 in order to get the video pattern within the limits of the bezel gauge. Using crosshatch, approximately 1" squares, pattern vertical and horizontal block sizes must not differ by more than 7% calculated as follows:

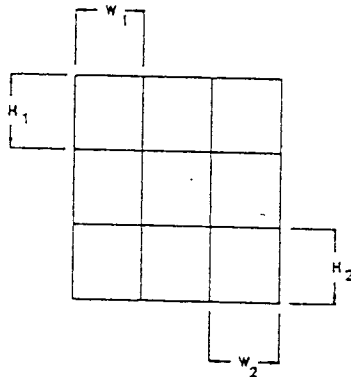

FOR ANY TWO BOXES:

$$-0.07 \leq \frac{2(W_1 - W_2)}{W_1 + W_2} \leq .07$$

AND

$$-0.07 \leq \frac{2(H_1 - H_2)}{H_1 + H_2} \leq .07$$

b) All edges of the active video area shall fall inside of the limits of the bezel gauge, including the effects of geometric distortions as pincushion, barrel, trapezoid, parallelogram and raster rotation.

The raster shape and orientation shall not be objectionable due to wavy edges, apparent rotation etc.

Raster rotation not to exceed 3mm as measured vertically on a center horizontal line of the display area.

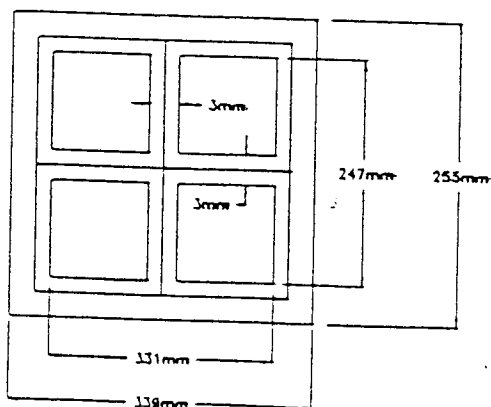

Fig. 4.3.1.6 Geometry Target Limits

TITLE

SERVICE MANUAL
MODEL: M19P114P/7103

PART NO.

5107 991 05491

SHEET 16 OF 79

4.3.1.7 Brightness Adjustment

Important Note:

During the adjustment procedure please be careful not to touch black level preset R633. (This control has been already adjusted at board level).

1. Apply signal, reverse video pattern. (White screen)
2. External Brightness Control R415 to detent.
3. Adjust R607 (Maximum Contrast Preset) to achieve $36V_{pp}$ video swing at CRT cathode.
4. Adjust Brightness Preset R410 for $21. \pm 3$ FL at the centre of the CRT.
5. External Brightness Control R415 to maximum.
6. Adjust R416 (Maximum Brightness Preset) for 35 ± 5 FL at the centre of the screen.
7. Brightness Control Action: Observe the screen while adjusting the Brightness Control to ensure smooth, continuous action of the control.

NOTE: Since the video output is set at $36VP-P$, this places the raster far into cut-off and under no signal conditions, the raster may not be visible, even when the external brightness control is adjusted to maximum. If necessary R410 Brightness Preset can be adjusted in order to increase the brightness so that the raster is just visible. If the brightness is set too high the EHT overcurrent sensing circuit will switch power supply off.

REV

AUTORISATION ECRIRE UN PROPOS EN TAILLE

THE PROPRIETOR.

ELECTRONIC DISPLAY



4.3.1.8 Dynamic Focus

4.3.1.8.1 Horizontal dynamic focus phase adjustment:

- Select an all white video pattern.
- Connect scope probe (no more than 2.5pF) to the drain tap of Q502 (TP501). and probe B to CRT cathode.
- Turn R504 (dynamic focus modulation) to minimum. (CW)
- Tune T501 (dynamic focus phase) with non metallic screw driver to obtain symmetrical pattern as per Fig. 4.3.1.8.1 with respect to video waveform.

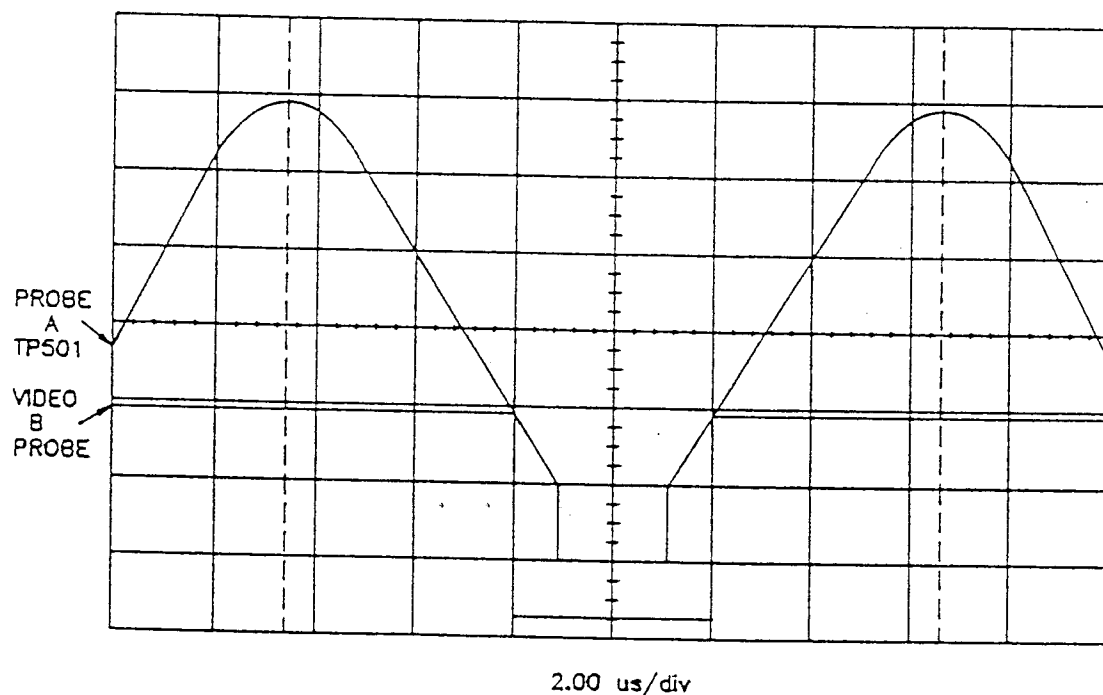

4.3.1.8.2 Focus Adjustment

External Brightness Control to be set to minimum.

- a) Get crosshatched pattern in normal video with "Chevron" pattern superimposed on the same.
- b) Adjust R522 for best focus at the centre of the screen.
- c) Adjust R506 for best focus at the sides of picture (at 3 & 9 o'clock position).
- d) Adjust R503 to achieve best focus along the top and bottom of picture (at 6 & 12 o'clock position).
- e) Adjust R504 to achieve best focus in the corner area of the picture.
- f) Retouch R522 to achieve a best overall focus.
- g) All the pixels should be discernable over the entire screen.
- h) Check overall focus performance, including screen center. Check that all perimeter locations are adjusted for optimum focus. This can be accomplished by slightly adjusting the Static Focus control above and below its final setting while observing each location. If any location is not at optimum focus, re-adjust as described above in steps C. and G.
- i) Readjust external brightness control to detent.

Focus Acceptance Criteria

The dark lines of each spiral character should be reasonably discernable anywhere within the viewing area.

Video Amplifier - Service Adjustment

4.3.2.1 D.C Setpoint (Black Level) Adjustment

- a) Remove video signal from unit
- b) Measure output voltage (D.C.) of video amplifier at either end of R634 with respect to ground.
- c) Adjust R633 to achieve a level of $48V \pm .5Vdc$

4.3.2.2 Gain

- a) Apply white field video signal, at the input of the video amplifier.
- b) Adjust int. gain pre-set pot R607, to achieve 36 volts peak to peak video at the output of the video amp. (R634).

4.3.2.3 H.F. Peaking - Adjust C627 for minimum ringing after a black to white transition.

4.4 Torque Table and Control Locations

4.4.1 Torque Table

4.3.1	CRT mounting	28.0 in lb.
4.3.2	Chassis Assembly	10.0 in lb.
4.3.3	Yoke Clamp	5.0 in lb. *
4.3.4	Video Ass'y Clamp	5.0 in lb.
4.3.5	Main bd. Heatsink to Chassis	14.0 in lb.
4.3.6	BNC Nuts	16.0 in lb.
4.3.7	Chassis and Bezel Components	
	Input Filter:	14.0 in lb.
	Bezel:	12.0 in lb.
	Top Screen:	10.0 in lb.
	Base Assembly	14.0 in lb.
	Rear Cover:	14.0 in lb.
	LED Assy	8.0 in lb.

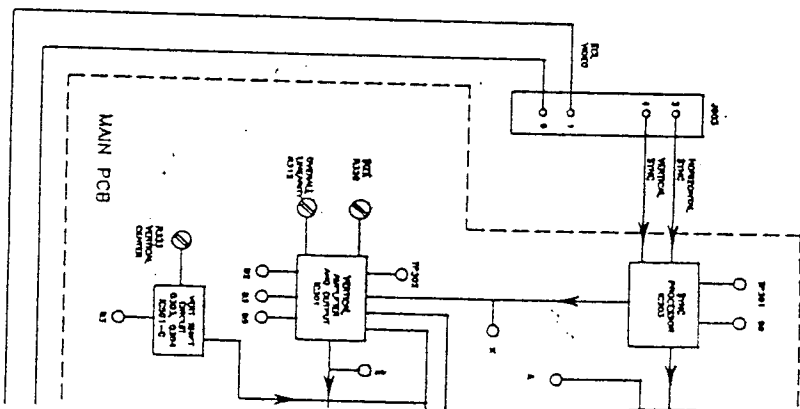
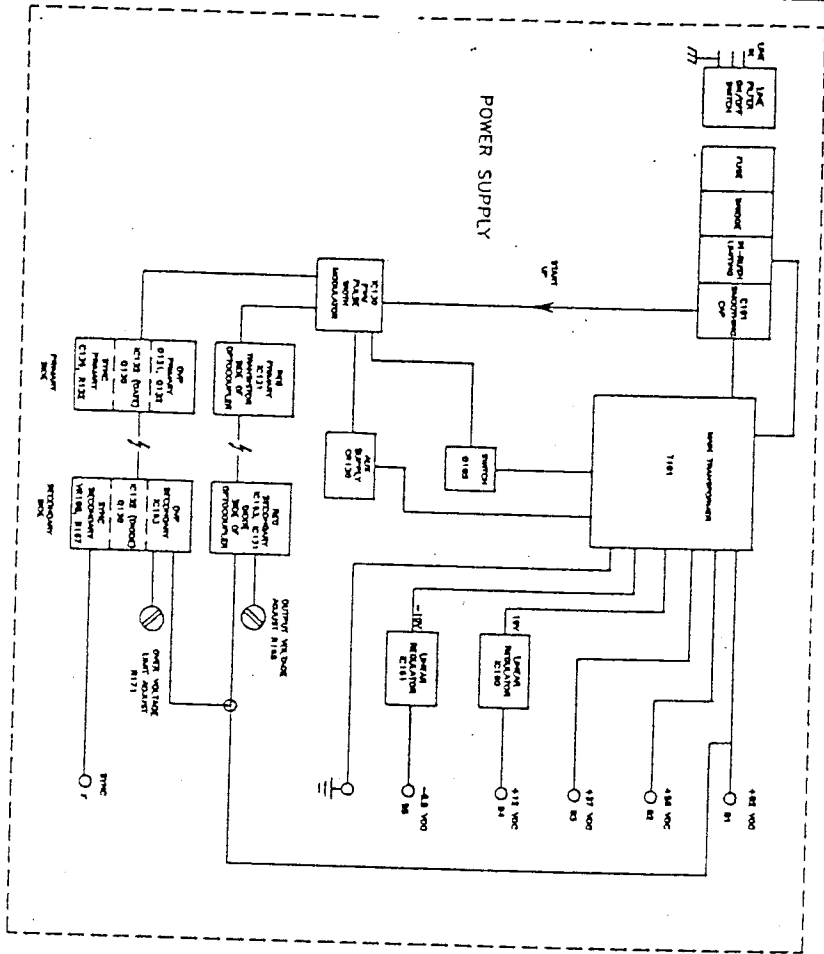

SECTION 6

TROUBLE SHOOTING CHARTS

PROBLEM 1. NO RASTER, NO E.H.T.

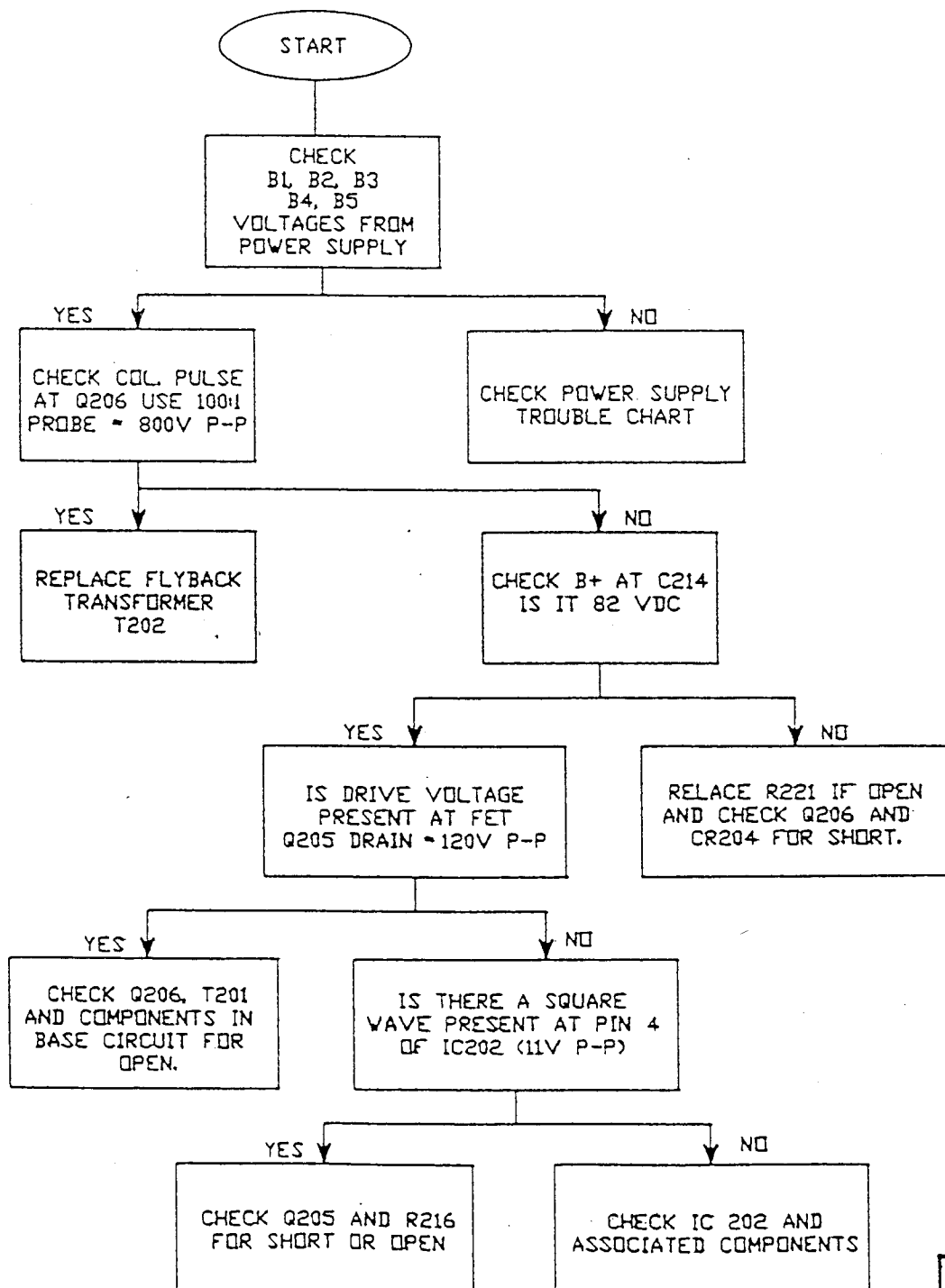
CAUSE: THE FLYBACK OR ITS SURROUNDING CIRCUITRY
THE PROTECTION CIRCUITS OR THE POWER SUPPLY.

TROUBLE SHOOTING

PROBLEM 2. NO RASTER, E.H.T. NORMAL

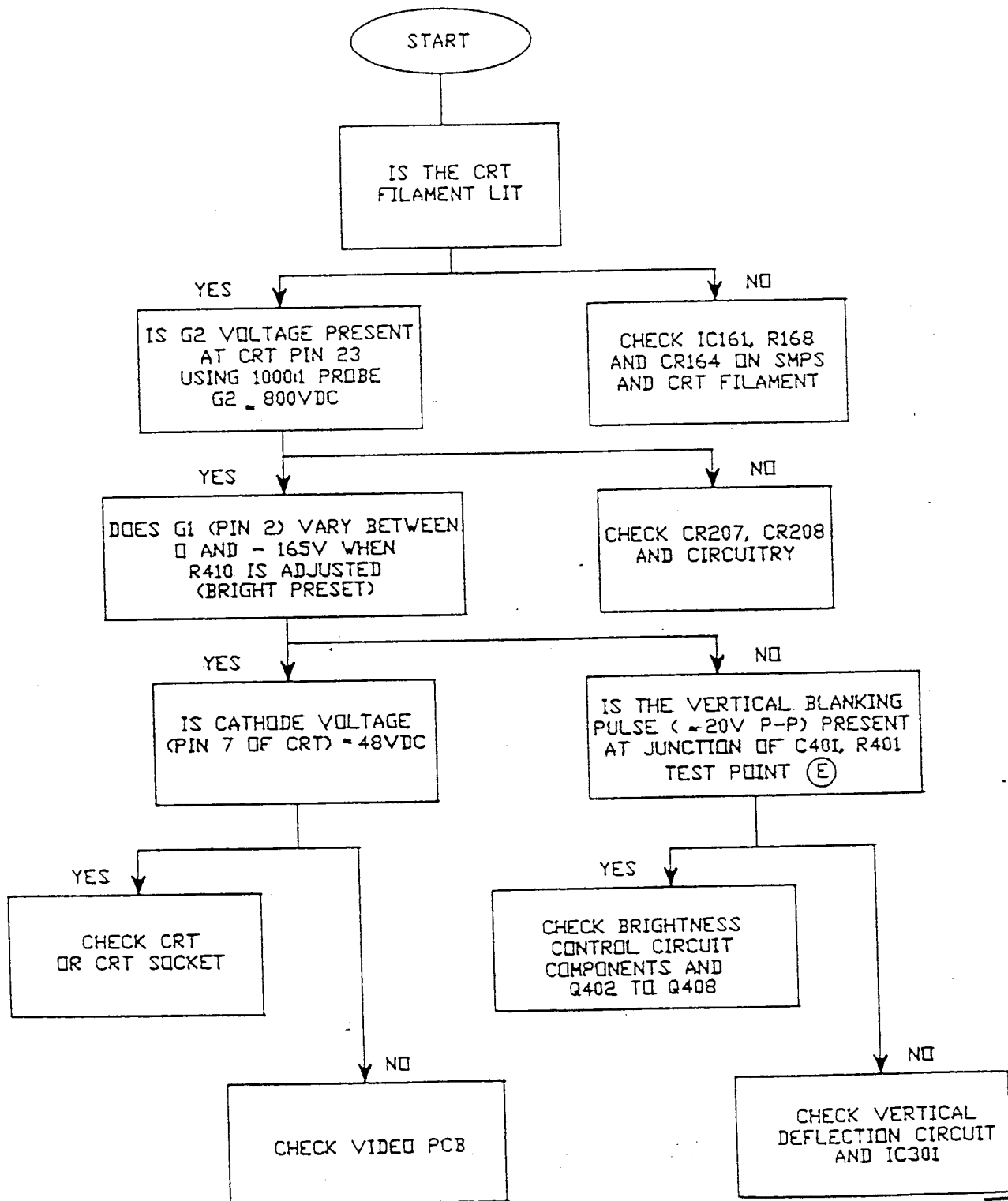

TROUBLE SHOOTING

PROBLEM 3. VIDEO PROBLEM (RASTER NORMAL)

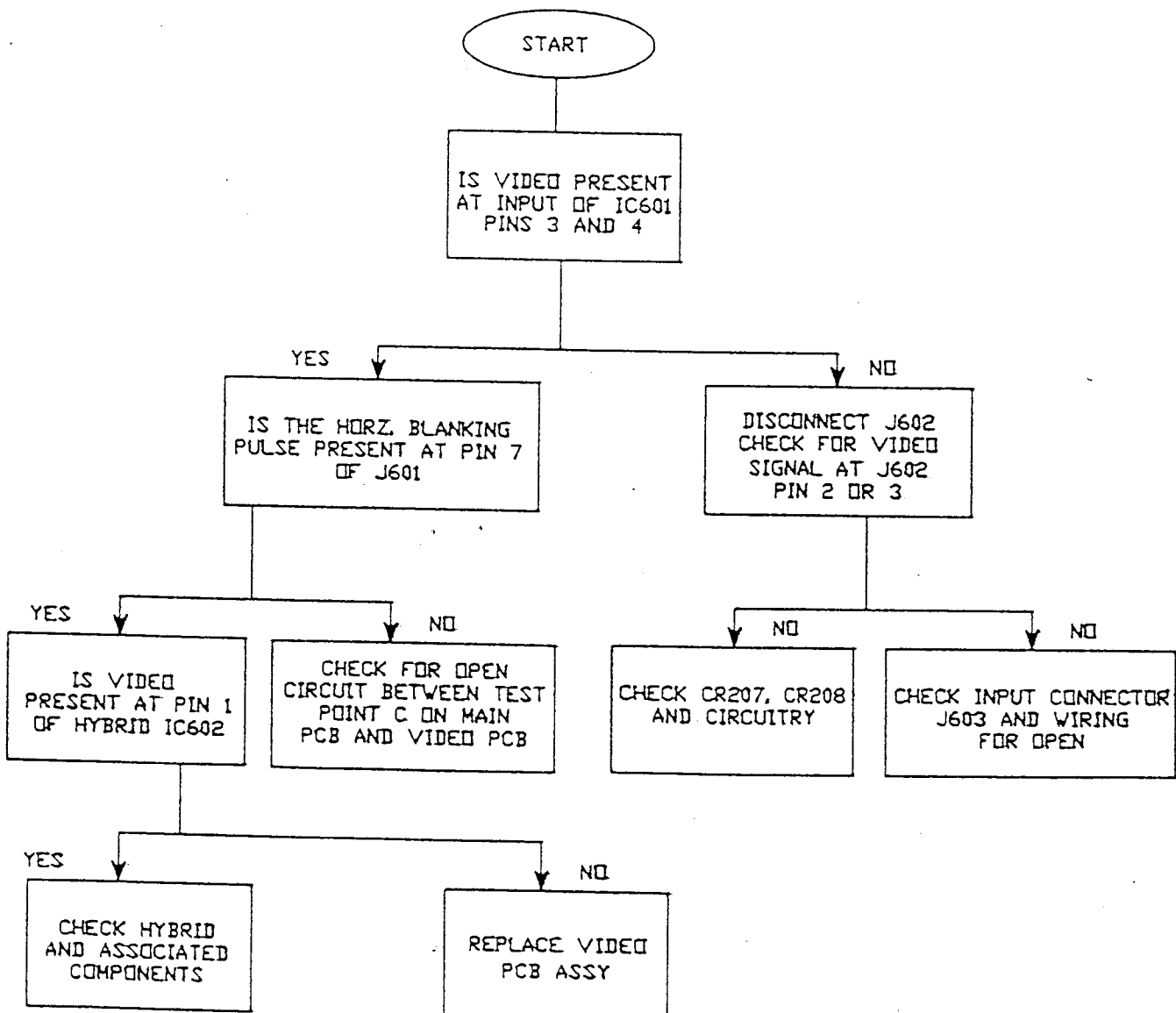

TROUBLE SHOOTING

PROBLEM 4. FOCUS PROBLEM

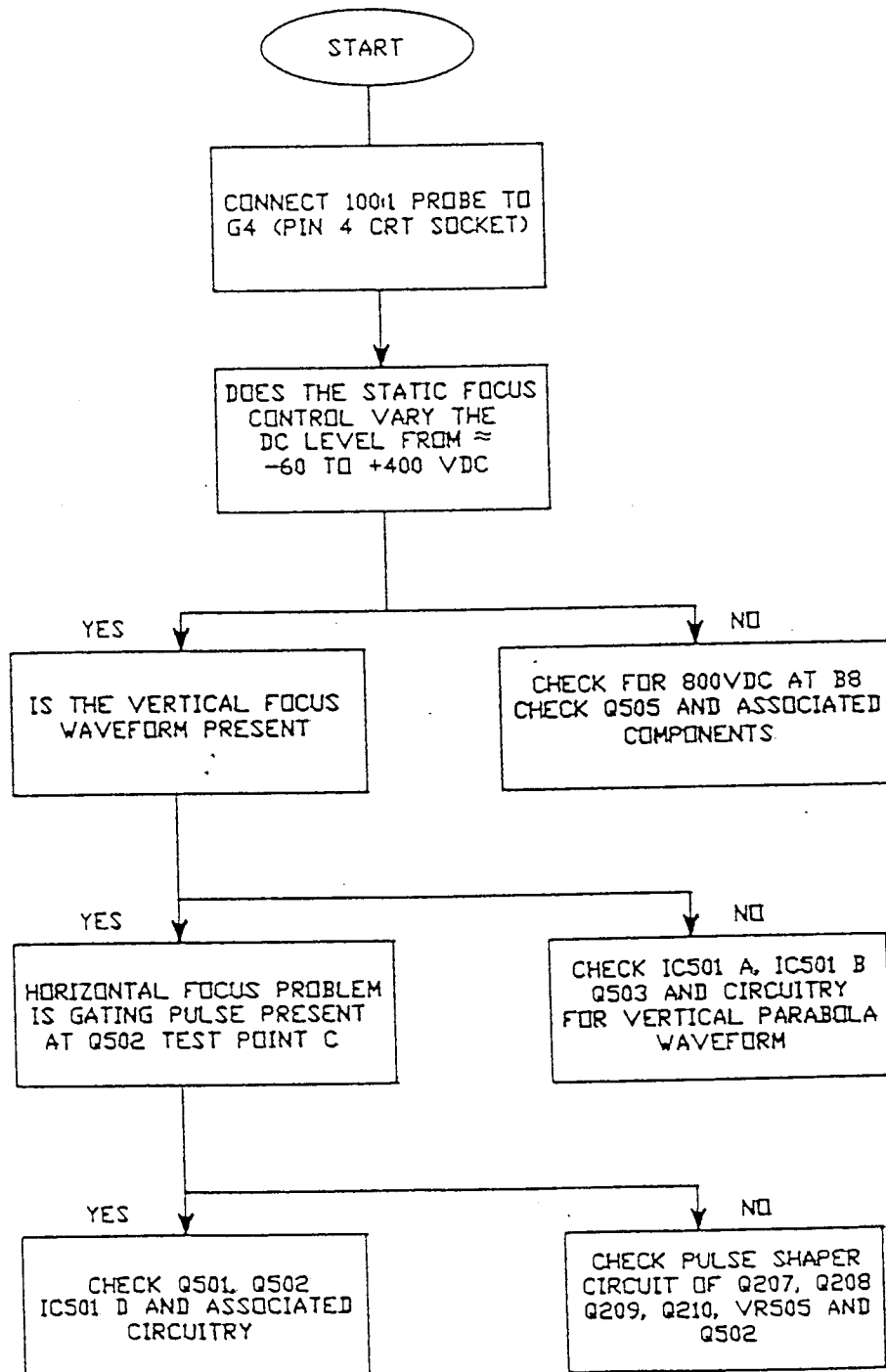

TROUBLE SHOOTING

PROBLEM 5. NO SYNC

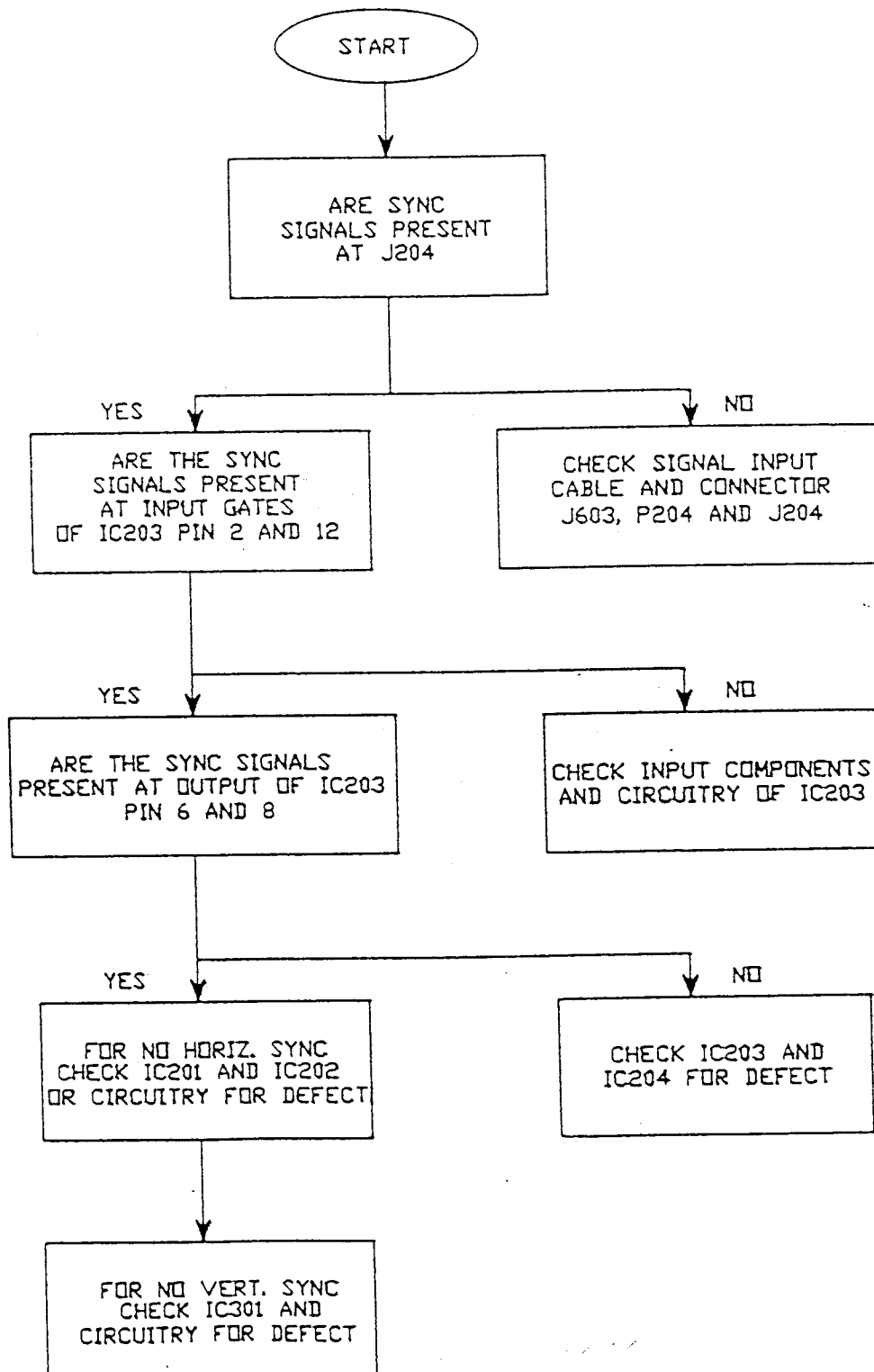

TROUBLE SHOOTING

PROBLEM 6. POWER SUPPLY

WARNING
BEFORE ANY MEASUREMENTS ARE MADE TO THE POWER SUPPLY
IT IS ESSENTIAL THAT THE UNIT BE ISOLATED FROM THE LINE
BY MEANS OF AN ISOLATION TRANSFORMER.

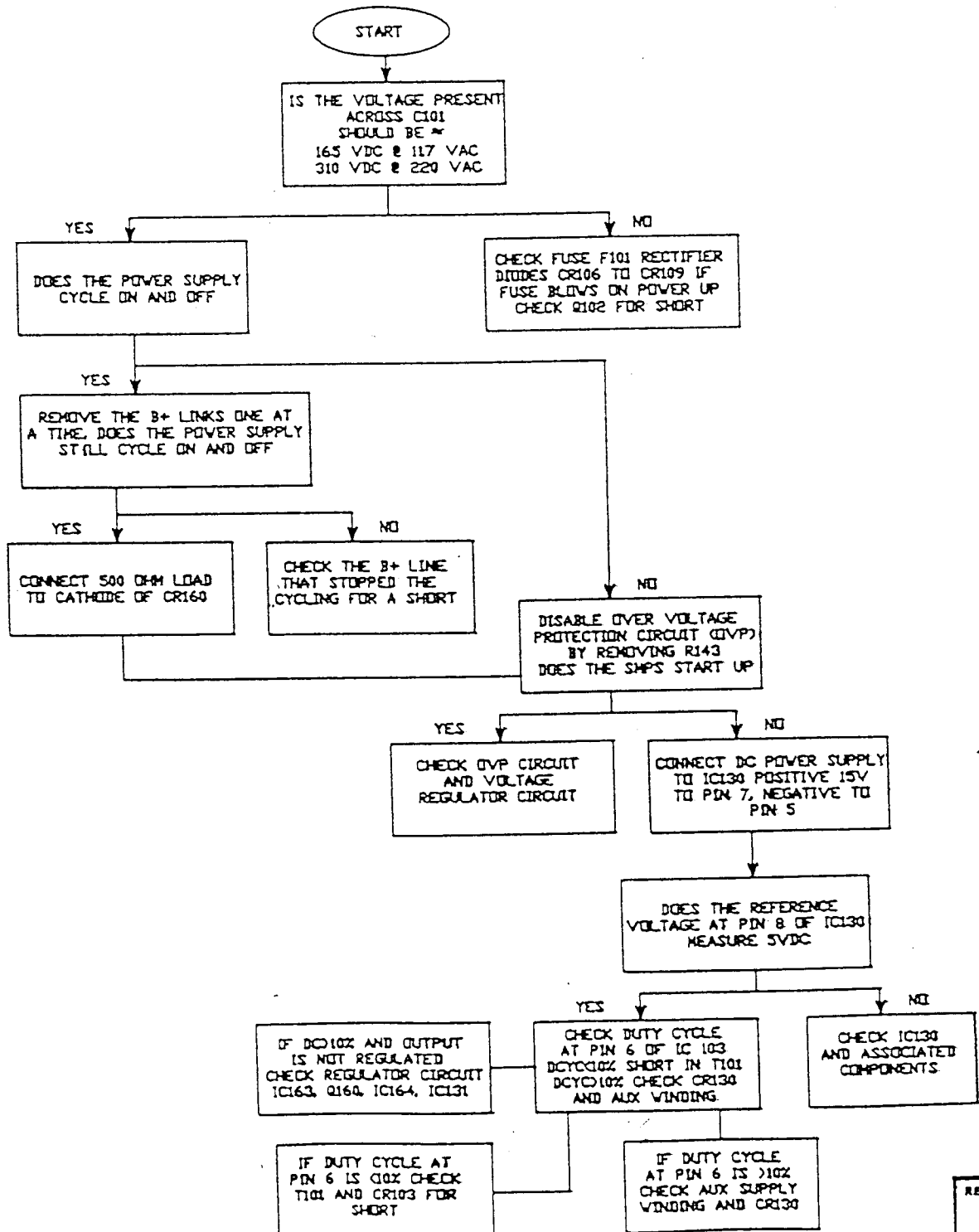

TITLE

SERVICE MANUAL
MODEL: M19P114P/7103

PART NO.

5107 991 05491

SHEET

27 OF

79

SECTION 7.

CURRENT AND VOLTAGE WAVEFORMS

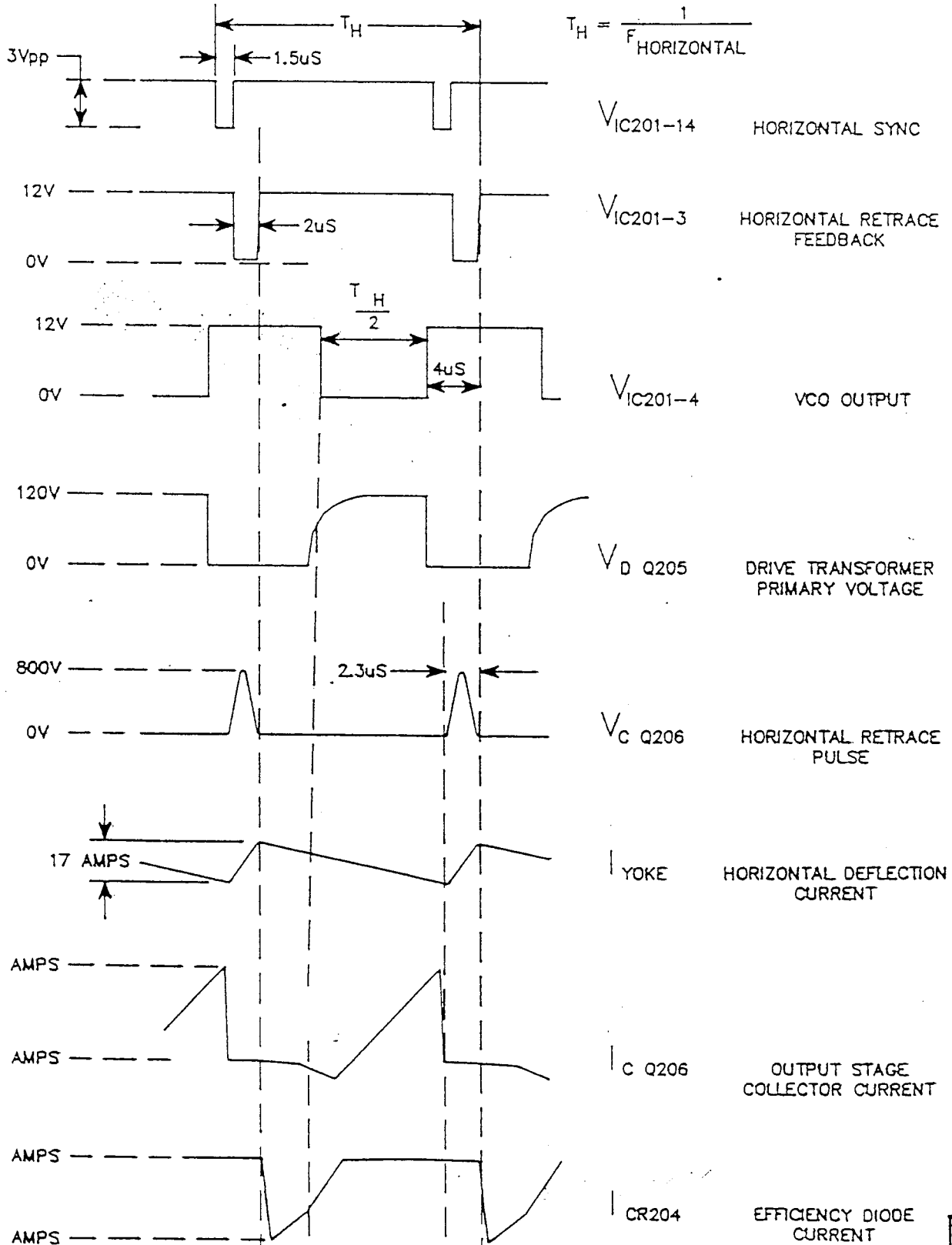

REV

VERTICAL DEFLECTION WAVEFORMS

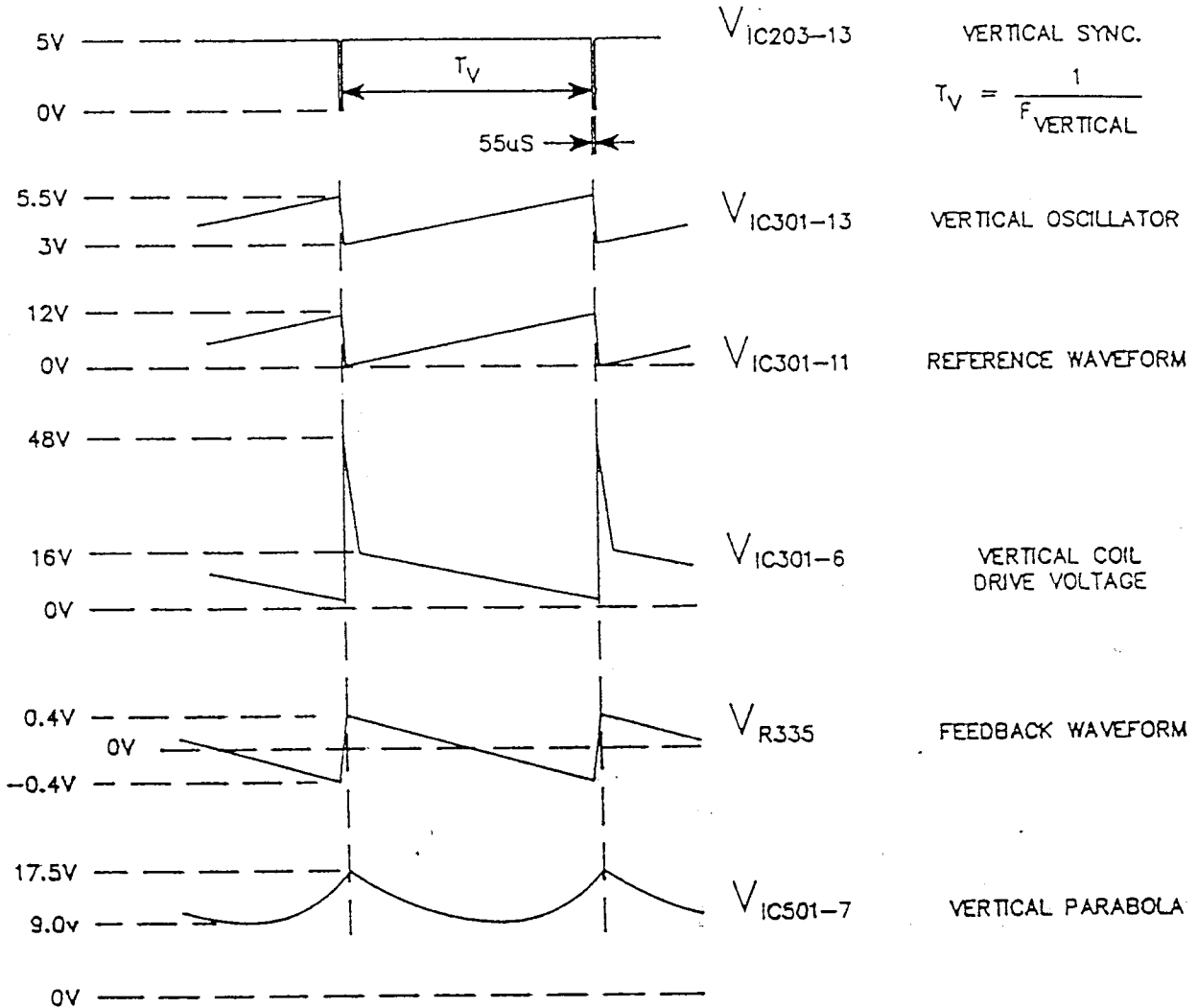

SECTION 8THEORY OF OPERATION8.1 Main Board

The main board hosts circuitry for the off-line SMPS, horizontal and vertical deflection, flyback transformer, CRT bias, dynamic focus circuitry, and safety circuit to prevent X-ray emission.

8.1.1 Power Supply

8.1.1.1 Summary

Operating from a power line of 90 - 264 VAC, the switch supply delivers a power of 50 Watts into five D.C. outputs.

The power supply consists of the following building blocks.

- * A.C. Line Filter
- * A.C. Line Bridge Rectifier and Smoothing Capacitor
- * Isolated D.C. to D.C. Buck-Boost Converter
- * Control Circuitry:
 - Pulse Width Modulator (PWM)
 - Voltage Feedback
 - Over Voltage Protection
 - Horizontal Defl. Sync. Circuit

8.1.1.2 Line Filter

The line filter is necessary to limit the conducted electromagnetic interference to the A.C. power source. The filter components are enclosed in a metal case, together with the IEC Power Connector and the ON/OFF Switch. This assembly is mounted onto the chassis rear panel with two screws.

8.1.1.3 Line Bridge Rectifier and Smoothing Capacitor

Diodes CR106 - 109 form a bridge rectifier. Capacitor C101 smoothes out the rectified voltage to a D.C. value plus a 2 x Line Frequency Ripple Voltage. When the A.C. supply varies from 90 - 264 VAC, the voltage across C101 varies from 100 - 400V.

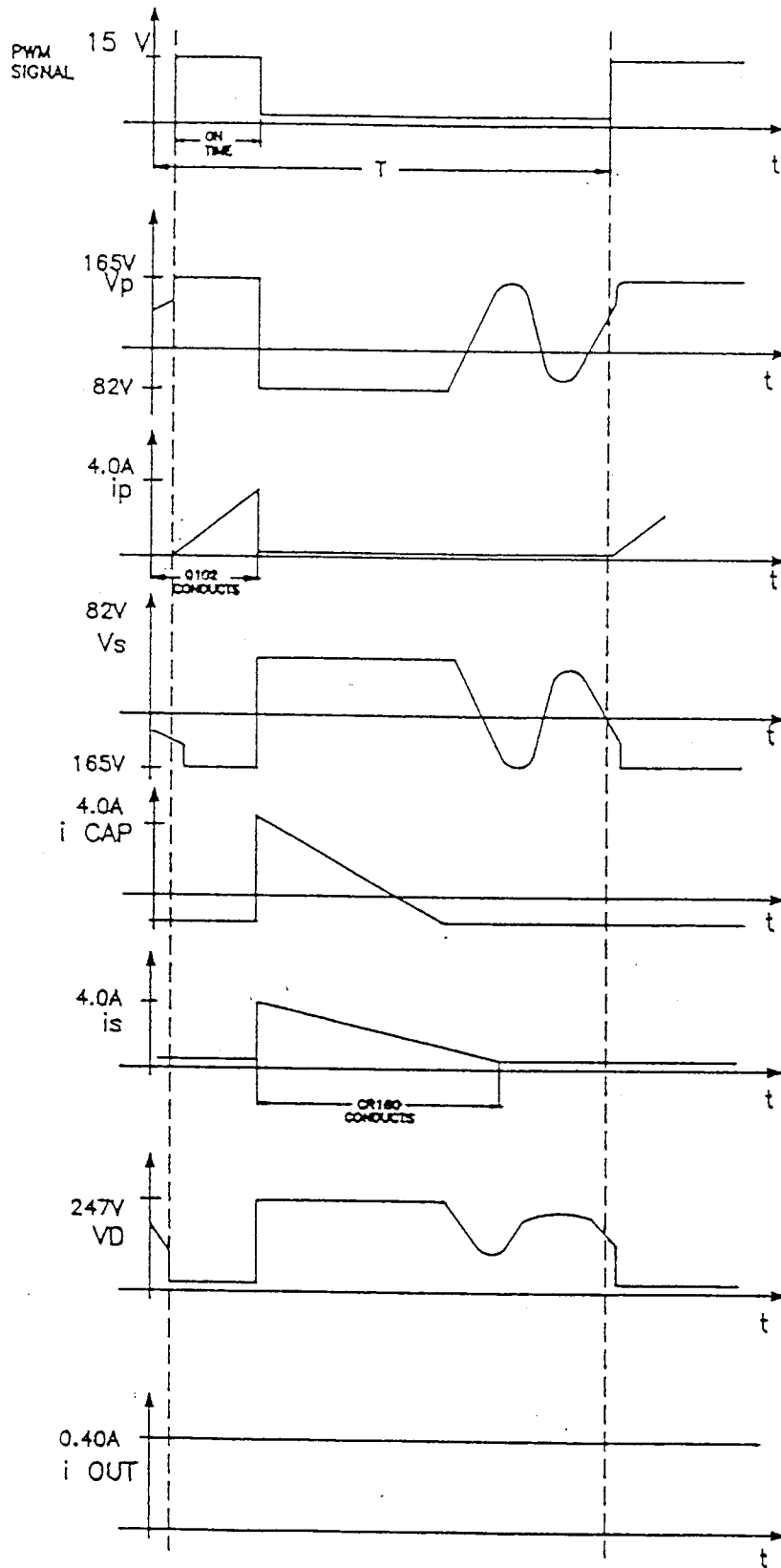

Figure 2: Typical waveform of the Isolated Buck-Boost Circuit

The converter operates in the discontinuous current mode. It is a three state circuit: first the switch Q102 is turned on, second Q102 is off and CR160 conducts, and third, neither Q102 or CR160 conducts. For any value of input voltage of load condition the circuit always cycles through these three states.

8.1.1.4 Control Circuitry

The control circuitry consists of four elements. The Pulse Width Modulator (PWM), Voltage Feedback Network, Over Voltage Protection, and Horizontal Deflection Synchronizing Circuit.

8.1.1.4.1 Pulse Width Modulator

The PWM is implemented using the UC3842AN (IC130), which is a current mode controller by Unitrode. The output of IC130 at pin 6, remains ON until the current sensed by pin 3 reaches a set value. The current level in the primary of T101 is determined by the value of resistor R106 and the set point at pin 3. This constitutes the inner current loop of the converter.

8.1.1.4.2 Voltage Feedback

The voltage feedback determines how much current in the primary is necessary to produce the desired output voltage of 82.0Volts @ 450mA. The transformer T101 is designed to produce the following auxiliary voltages:

+58V @ 200mA
+27V @ 300mA
+12V @ 200mA
-6.3V @ 330mA

The voltage loop consists of a voltage divider R164, R165, and R166, that feeds a shunt regulator, IC163 (TL431). The shunt regulator adjusts its output voltage (at the Cathode) to obtain a fixed 2.50V at its input (the reference). Using R162, a current is developed in the diode part of the Optocoupler IC131 which is reflected to the transistor section. The current flowing into R131 creates a D.C. voltage whose value controls the magnitude of the primary current, and consequently set the output voltage. This system constitutes the outer voltage feedback loop.

Q207 provides a current source. The value of the current is proportional to the free running frequency and adjusted by R230.

R229 provides a current offset at the opamp input. That input remains at a constant DC voltage and since there is no other DC feedback path the way the PLL circuit can compensate the offset is to shift the phase of its generator to provide a pulse of an appropriate width at the phase detector output. That pulse is converted into current by R231 and an equilibrium is reached. By means of adjustment of R229 the offset current is changed and so is the horizontal phase.

Q201 and Q202 are used in order to delay start-up. The PLL will not start until sufficient power supply voltage is reached in order for VCO to be able to generate the right frequency. This way an overload condition during power-up is eliminated.

8.1.2.3 Driver and power stage, horizontal output.

A small power MOSFET Q205 is used in the driver stage. Driver Transformer T201 is employed in order to obtain proper base current during the on state of the horizontal output transformer Q206. When the driver transistor switches on Q206 switches off initiating horizontal retrace. The flyback transformer is used to provide EHT as well as voltages for G1, G2, and the focus circuit.

Key Components:

C215 Pulse capacitor
C216 S-correction capacitor
L202 Width control coil
L203 Linearity coil
L205 HFS coil, 3rd harmonic S-correction coil
T202 FBK transformer
Q206 Line output transistor

8.1.2.4 Safety circuit, X-ray emission protection.

IC701-A limits the EHT and anode current such that the worst case combination of these two values will not exceed the isoexposure curve for the implemented picture tube.

EHT is sensed indirectly through the collector pulse and anode current is measured with the drop resistor R705.

Should the limit for the EHT/anode current combination be exceeded the shutdown signal is sent to the power supply. Power will have to be disconnected for a while to allow the latch to reset. (Approximately 30 seconds - see Power Supply).

Note: The following components are critical for safety of the monitor user and should only be replaced by the original types: T202, CR702, R705, CR702, IC701, R702, R703, R704, IC160.

8.1.3 Vertical Deflection.

Vertical deflection provides a sawtooth current waveform in the vertical coils of the deflection yoke to effect vertical displacement of the electron beam. The vertical circuit is built around the TDA2653A. Specifically the following features are worth mentioning:

8.1.3.1 Vertical Linearity

Vertical linearity compensation is achieved by distorting the reference ramp at pin 11 using positive feedback from pin 3 (IC301) to the junction of capacitors C313 and C314

8.1.3.2 Vertical Shift

Q303, Q304 and IC501-C provide a circuit for vertical shift.

The circuit can source and sink current from IC301 output via the vertical deflection coil. By adjusting this current the position of the raster can be adjusted on the face of the CRT. Since it looks as a current source from the coil side it does not affect the linearity.

8.1.3.3 Vertical Retrace

Q302 is used to shorten the retrace time.

8.1.3.4 Crosstalk

Vertical crosstalk filter L301 is implemented to reduce crosstalk and ringing occurring because of the interaction of the horizontal & vertical deflection coils.

8.1.3.5 Adjustments

- R335 - Free running
- R312 - Linearity
- R329 - Height
- R339 - Vertical center

8.1.4 Focus

The focus circuitry provides a complex waveform voltage to the G4 electrode of the CRT. This focus voltage waveform consists of a D.C. component, a parabolic waveform component at the vertical frequency, and a sinusoidal waveform component at the horizontal frequency. The amplitude of the horizontal component is modulated by a parabolic waveform at the vertical frequency.

Main circuit blocks:

- Vertical sawtooth waveform integrator IC-501-B
- Modulator IC501-D
- Horizontal component output stage Q502.
- Vertical component output stage Q503, IC501-A
- Horizontal component transformer T501
- Static focus circuit Q505

8.1.4.1 Vertical Component:

A sawtooth waveform across current sensing resistor R323 is integrated by IC501-B. The resulting parabola is then amplified by the vertical component output stage and coupled through R538 to G4.

8.1.4.2 Horizontal Component:

The horizontal frequency component of the focus waveform is generated by applying short duration, low voltage pulses across the primary of transformer T501. Due to step-up design of this transformer, the peak secondary voltage is much larger than the primary voltage. The pulses excite the parallel resonant circuit formed by the secondary of T501 and capacitors C506 and C507. The inductance of T501 is adjusted such that the horizontal focus waveform is in phase with horizontal deflection.

The waveform at TP501, obtained with low capacitance scope probe of 2.5pF maximum, should look like this:

no running

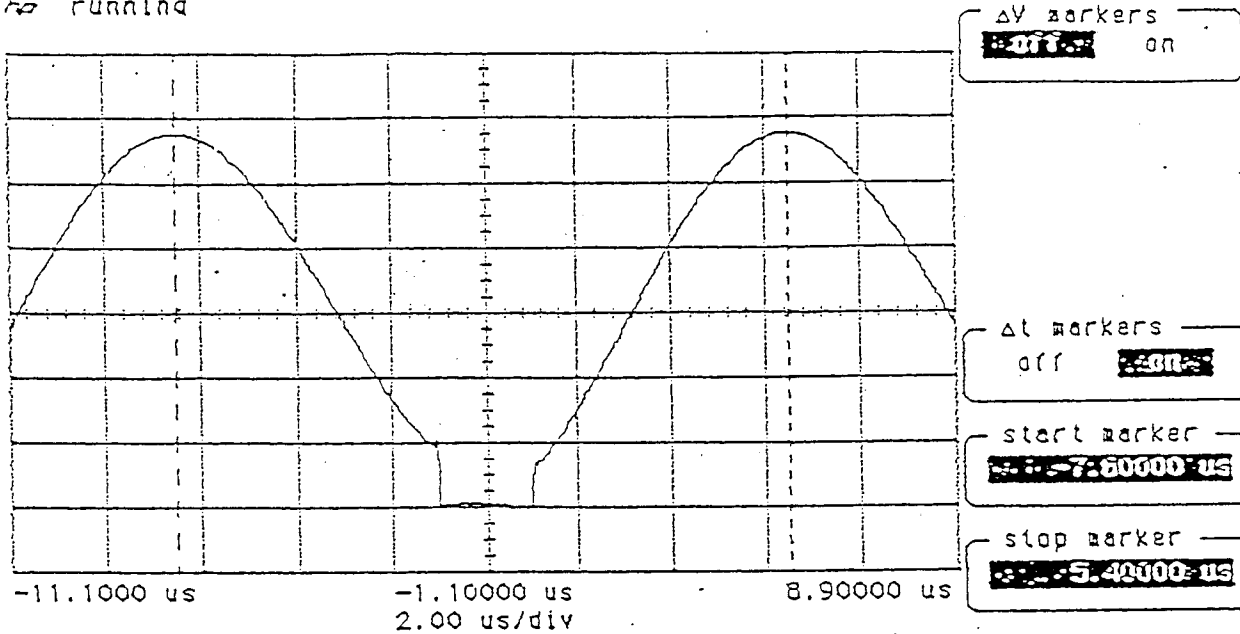

stop marker: 5.40000us
 start marker: -7.60000us
 delta t: 13.0000us
 1/delta t: 76.9231kHz

The amplitude of the waveform is dependant upon the output of the voltage source Q501. The D.C. component of this voltage is adjustable and this way the amount of horizontal component is controlled.

8.1.4.3 Modulation.

The vertical parabola is also used to modulate the horizontal component. To accomplish that the vertical parabola waveform is fed to IC501-D and is added to the DC component at Q501 output. The vertical component causes the amplitude of the horizontal component to vary, dependant on the position of the beam on the screen face. The amplitude is higher towards the top and bottom of the screen, such that the voltage is higher in the corners than at the sides. The amount of modulation is adjustable.

8.1.4.4 Static Focus

The static focus circuitry incorporates a voltage clamping circuit to impose a constant minimum voltage on the dynamic focus waveform. The minimum voltage corresponds to the center of screen focus voltage. The clamping circuit comprising of capacitor C509 and diode CR501, prevents the voltage from falling below the voltage at the drain of Q505. The clamping action causes a net DC voltage to develop across C509. Resistor R518 provides a discharge path for C509 in order that the charge on this capacitor will track the voltage at the drain of Q505.

8.1.4.5 Adjustments

- R522 - static focus (focus at the center of the screen)
- R506 - horizontal component (focus at the sides; 3 and 9 o'clock)
- R503 - vertical component (focus at the top and bottom; 12 and 6 o'clock)
- R504 - modulation of the horizontal component, (focus in the corners)

8.1.5 Brightness Adjustment Circuit.

This G1 control circuit provides independent adjustment of the external brightness control @ detent position (R410 brightness preset), and of the external brightness control range (R416 maximum brightness preset). This feature permits precise adjustment of the maximum user brightness control without affecting the raster cutoff setting at the brightness control detent position.

This circuitry also provides three blanking functions: vertical retrace blanking, spot kill on power down, and blanking in the event of vertical deflection failure.

- Major Blocks:
- retrace blanking and spot killer Q401, Q404
 - vertical retrace sensor Q402
 - differential amplifier Q406, Q407, Q408
 - current sources Q405, Q403

8.1.5 Brightness Adjustment Circuit. Cont'd

The Q402 circuit detects the presence of the vertical retrace.

Under normal operating conditions, the sawtooth current that flows through the vertical coils of the deflection yoke produce a retrace voltage. This retrace signal is detected by the diodes CR401 and CR402, and fed through zener diode VR401 to the base of Q402, which is turned on. This switches on the current sources Q405 and Q403, and also Q404. Transistor Q404 feeds the input of the differential amp, Q406 and Q407, with a voltage value determined by the position of the brightness preset pot, R410. The differential amp begins to stabilize that value at the junction of the resistor network R409, R408, and R413. Resistors R409 and R408 are parallel to the user brightness control R415. The current flowing through that network determines the voltage drop across the user control pot, and so the amount of G1, and thus brightness, variation achievable by the user pot. This current is adjusted by maximum brightness preset R416.

In the event that R415 is disconnected, R413 will provide G1 bias.

8.1.5.1 Adjustments

R410 - brightness preset; user control at detent position
R416 - maximum brightness preset; user control at maximum position.

8.2 Video Board

8.2.1 General

This video amplifier is based on a hybrid device for the output stage and a two quadrant multiplier preamplifier with D.C. gain control. Gated D.C. restoration triggered by the horizontal retrace pulse is applied during horizontal blanking.

8.2.2 Preamplifier

The balanced ECL video signal is applied to the input of the ECL to TTL converter IC601 through connector J602.

Resistors R601//R603 and R602//R604 provide the proper input impedance for the video signal.

CR601, CR602, CR603, CR604 are protection diodes.

Transistor Q601 is an emitter follower and supplies the positive power supply voltage for IC601. Variable resistor R607 changes the voltage applied to the base of Q601 and in consequence the B+ applied to pin 12 of IC601.

Since the output voltage of IC601 is proportional to the B+ voltage applied to IC601, variable resistor R607 controls the gain of the preamplifier.

R607 is adjusted to obtain 36 volts peak to peak at the output of IC602 when a white ECL video signal is applied to the input of the video amplifier.

The output of the preamplifier is AC coupled through C607 to the base of the emitter follower Q602.

The emitter of Q602 is connected to the negative input of the hybrid output stage IC602. The high frequency network R625, C627, C628 optimizes the frequency response of the output stage to obtain a flat output with a minimum overshoot at high frequencies.

8.2.3 Black Level Stabilization (DC Restoration)

Since the video signal passes through coupling capacitors in the preamplifier stages, the DC level information is lost. A DC restoration circuit is necessary to maintain a constant black level at the output of the video amplifier for any type of input signal.

In order to maintain the output stage operating within its linear range, the black level is set approximately 10 Volts below the power supply B+. In this case, the black level is preset at 48 Volts DC by adjusting the variable resistor R633.

Transistors Q603 and Q604 are part of the DC restoration circuitry.

With no signal, the output of the video amplifier should be a DC level which coincides with the black level of the video signal and this level depends on the bias point of transistor Q602.

Let us consider first a situation where no signal is applied at the input of the video amplifier, and the two extreme conditions expressed under (a) and (b) below.

- a) If transistor Q603 is OFF, the current through R620, R621 is high enough to bias the emitter of Q602 at a high level. Since IC602 is an inverting amplifier, a high level at the input would cause the DC output of the video amplifier to be very close to ground potential.
- b) DC transistor Q603 is in saturation, its collector voltage would be at ground potential, the emitter voltage of Q602 at approximately -0.7 Volts and the output of the video amplifier very close to the power supply level.

TITLE

SERVICE MANUAL
MODEL: M19P114P/7103

PART NO.

5107 991 05491

SHEET

44 OF 79

Under normal operating conditions, none of the above conditions exist because the negative feedback loop keeps the black level at the preset value within 2%.

In order to maintain the black level constant, a sample of the video output is taken from the divider consisting of R631, CR602, R632 and R633. This signal is then applied to the transistor Q604, operating as an inverting amplifier.

A trigger pulse (clamping pulse) during the horizontal blanking interval is applied at the base of transistor Q603 to switch on this transistor only during the blanking interval of the video signal.

During the horizontal blanking interval the collector voltage of Q604 (cathode of CR601) is around ground potential. Since, emitter of Q603 is also at ground potential, the current through R628 due to the clamping pulse during blanking interval will be circulating either to the base of Q603 or through the diode CR605 depending on the collector voltage of Q604.

NOTE: Base-Emitter voltage versus current characteristics of Q603 and diode CR605 are very similar.

During blanking, if the output of the video amplifier reduces, the collector voltage of Q604 increases, the voltage across diode CR605 reduces and all the current from the clamping pulse is then applied to the base of Q603. Under this condition, the collector voltage of Q603 reduces, changing the bias of the video amplifier and increasing the output voltage to its nominal value (remember that the hybrid amplifier is an inverting amplifier).

Vice versa if the output of the video amplifier increases, the collector voltage of Q604 will be below ground potential, the diode CR605 forward bias increases and all the clamping pulse current flows through this diode turning transistor Q603 OFF and allowing the bias of Q602 to rise, causing the output of the video amplifier to fall.

Since this action is repeated line by line during the blanking time, the black level is maintained within a very narrow margin.

Capacitor C618 stores the energy to maintain the proper bias during the scanning interval when the clamping circuit is inactive.

Diode CR608 compensates for the base-emitter temperature variation of Q604.

REV

8.2.4 High Frequency Adjustment

The high frequency compensation capacitor C627 has to be adjusted in order to obtain a flat response with a reasonable overshoot over the entire range of operating frequencies.

The following procedure is recommended.

- a) Apply a white signal 0.714 Volts peak to peak with no more than 2 nsec. rise and fall times, when connected to the input of the video amplifier.
- b) Connect a FET probe with no more than 1.5 picofarads capacitance to the cathode of the CRT. (Recommended probe, Tek. P6202A). Ground lead must be very short in order to avoid ringing. (If the CRT is not connected add an external capacitor of 6pF.)
- c) Adjust the internal gain control R607 to obtain 36Vpp at the output of the video amplifier.
- d) Adjust variable capacitor C627 to obtain a flat frequency response with no more than 8% overshoot.
- e) Verify the duration of the overshoot less than 6 nsec. according to the following figure:

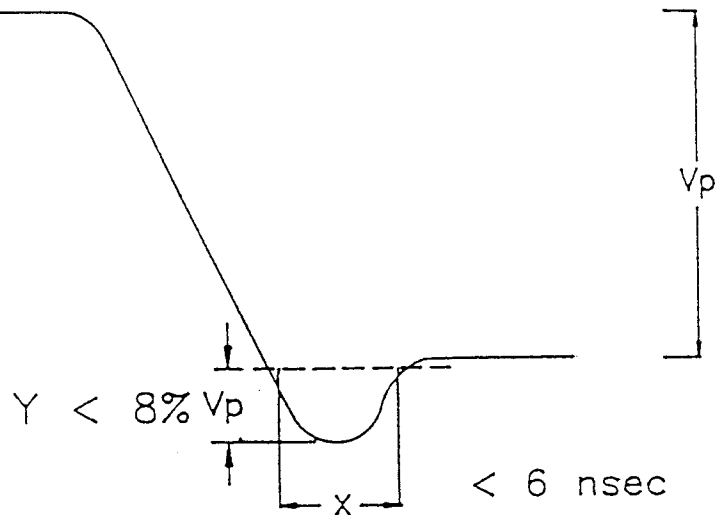

Another possible procedure for adjusting this high frequency compensation without using an oscilloscope is to use the monitor itself, displaying a cross-hatch test pattern of black vertical lines over white background and looking at the ringing after each transition from black to white it is possible to adjust the high frequency compensation visually until the ringing disappears.

VIDEO BOARD SERVICE PRINT

TOUS DROITS STRICTEMENT RESERVEES.
REPRODUCTION OU COMMUNICATION A DES TIERS
INTERDITE SOUS QUELQUE FORME QUE CE SOIT SANS
AUTORISATION ECRITE DU PROPRIETAIRE.

ALL RIGHTS STRICTLY RESERVED. REPRODUCTION OR
ISSUE TO THIRD PARTIES IN ANY FORM WHATEVER
IS NOT PERMITTED WITHOUT WRITTEN AUTHORITY FROM
THE PROPRIETOR.

ELECTRONIC DISPLAY

FORM 1980B 12/7

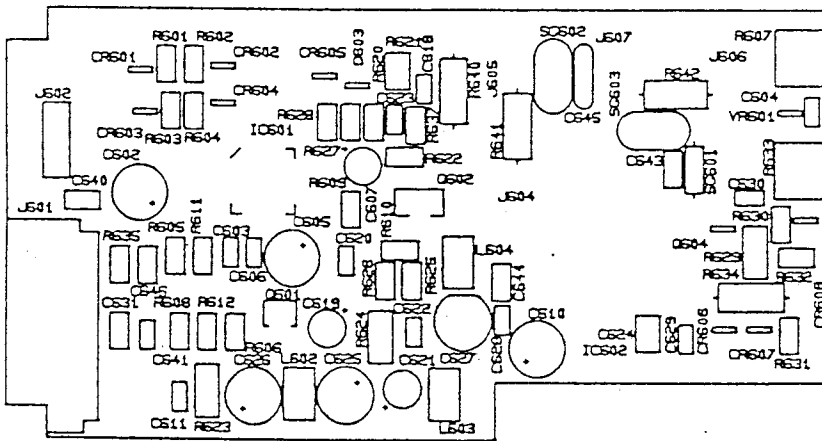

PHILIPS ELECTRONICS
M19P114P/7103 VIDEO PCB

SERVICE PRINT ARTWORK
5107 102 06801

DATE: 90-11-10
SHEET 1 OF 1

REV

SECTION 10
SEMICONDUCTOR LEAD ID

TOUS DROITS STRICTEMENT RESERVES.
 REPRODUCTION OU COMMUNICATION A DES TIERS
 INTERDITE SANS QUELQUE FORME QUE CE SOIT SANS
 AUTORISATION ECRITE DU PROPRIETAIRE.

ALL RIGHTS STRICTLY RESERVED. REPRODUCTION OR
 ISSUE TO THIRD PARTIES IN ANY FORM WHATSOEVER
 IS NOT PERMITTED WITHOUT WRITTEN AUTHORITY FROM
 THE PROPRIETOR.

REF. DESIGN.	DRAWING	MANUFACTURERS DESCRIPTION, P/N	PHILIPS P/N
Q401 Q402		BC546 PHILIPS	9332 055 20112
Q132 Q202 Q210 Q302		BC548 PHILIPS	9331 976 40112
Q130 Q131 Q160 Q201 Q209		BC558 PHILIPS	9332 377 80112
Q203		BC549 PHILIPS	9331 976 80112
Q403 Q404 Q405 Q406 Q407 Q408		BF423 PHILIPS	9332 593 60112

ELECTRONIC DISPLAY



REV

TITLE		PART NO.	
SERVICE MANUAL MODEL: M19P114P/7103		5107 991 05491	
		SHEET	56 OF 79
IC164		LM317LZ MOTOROLA 3 PIN REGULATOR	9338 221 50682
IC160		TL780-12C TEXAS INSTRUMENT 3 PIN REGULATOR	9332 013 87682
IC161		MC7905ACT MOTOROLA 3 PIN REGULATOR	9322 020 25682
IC201		TL081CP TEXAS INSTRUMENT	9322 106 79682
IC130		UC3842AN MOTOROLA	9339 410 40682
IC701		LM393N NATIONAL	9334 010 80682

REV

TOUS DROITS STRICTEMENT RESERVEES.
REPRODUCTION OU COMMUNICATION A DES TIERS
INTERDITE SANS QUELQUE FORME QUE CE SOIT SANS
AUTORISATION ECRITE DU PROPRIETAIRE.

ALL RIGHTS STRICTLY RESERVED. REPRODUCTION OR
ISSUE TO THIRD PARTIES IN ANY FORM WHATSOEVER
IS NOT PERMITTED WITHOUT WRITTEN AUTHORITY FROM
THE PROPRIETOR.

ELECTRONIC DISPLAY

SECTION 11
EXPLODED VIEW AND PACKING DIAGRAM

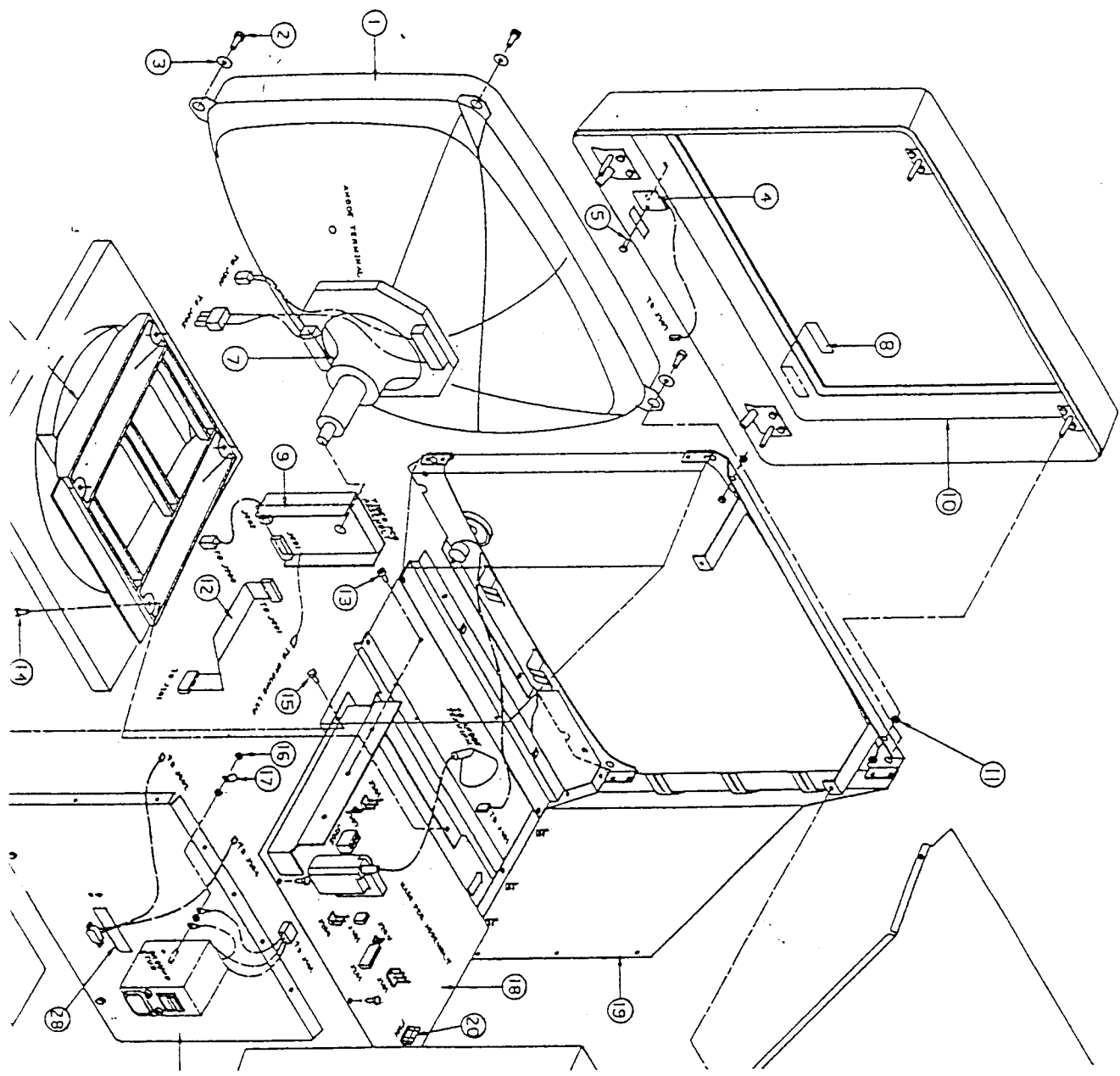

TITLE

SERVICE MANUAL
MODEL: M19P114P/7103

PART NO.

5107 991 05491

SHEET 57 OF 79

TOUS DROITS STRICTEMENT RESERVEES.
REPRODUCTION OU COMMUNICATION A DES TIERS
INTERDITE SANS QUELQUE FORME QUE CE SOIT SANS
AUTORISATION ECRITE DU PROPRIETAIRE.

ALL RIGHTS STRICTLY RESERVED. REPRODUCTION OR
ISSUE TO THIRD PARTIES IN ANY FORM WHATSOEVER
IS NOT PERMITTED WITHOUT WRITTEN AUTHORITY FROM
THE PROPRIETOR.

ELECTRONIC DISPLAY

FORM 1980B 12/77

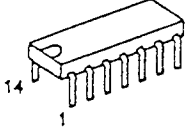
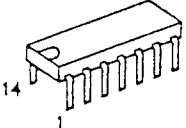
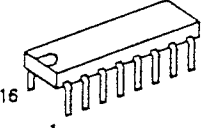
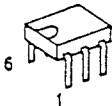
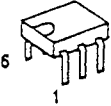
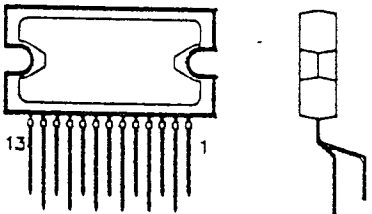
IC203		MC74HCT86 NATIONAL	9337 306 20682
IC501		LM324N SIGNETICS LM324N MOTOROLA LM324N NATIONAL LM324N TEXAS INST.	9332 576 30112 9336 305 00682 9322 576 30682 9335 004 40682
IC202		CD40468E RCA	9334 367 70682
IC131		MOC8101T OPTO ISOLATOR	9332 019 14682
IC132		H11NX513 OPTO ISOLATOR	5107 141 00024
IC301		TDA2653A	9337 116 30112

REV

PHILIPS

TITLE
SERVICE MANUAL
MODEL: M19P114P/7103

PART NO.
5107 991 05491
SHEET 58 OF 79

TOUS DROITS STRICTEMENT RESERVEES.
REPRODUCTION OU COMMUNICATION A DES TIERS
INTERDITE SANS QUELQUE FORME QUE CE SOIT SANS
AUTORISATION ECRITE DU PROPRIETAIRE.

ALL RIGHTS STRICTLY RESERVED. REPRODUCTION OR
ISSUE TO THIRD PARTIES IN ANY FORM WHATSOEVER
IS NOT PERMITTED WITHOUT WRITTEN AUTHORITY FROM
THE PROPRIETOR.

FORM 1980B 12/7

ELECTRONIC DISPLAY

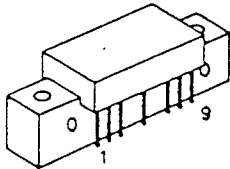
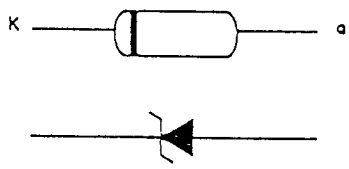

IC603		CR2425 MOTOROLA	9322 008 71682
VR401		BZX79C12 PHILIPS	9331 178 10113

REV

TITLE

SERVICE MANUAL
MODEL: M19P114P/7103

PART NO.

5107 991 05491

SHEET 60 OF 79

ITEM	PART NUMBER	DESCRIPTION	Q'TY
1	5105 155 00540	CRT	1
2	2507 200 03033	SCREW M5 X 12	4
3	2507 601 98018	WASHER	4
4	5107 190 12970	LED PCB ASSY	1
5	2507 001 04009	SCREW #6 X 1/4"	1
6	5107 190 12460	BASE ASSEMBLY	1
7	5107 190 12130	YOKE ASSEMBLY	1
8	5107 130 05600	LOGO	1
9	5107 190 13180	VIDEO ASSEMBLY	1
10	5107 190 13150	BEZEL ASSEMBLY	1
11	5107 010 02711	KEPS NUT M5	8
12	5107 190 12140	CABLE ASSEMBLY DC	1
13	2507 200 03021	SCREW M4 X 8	3
14	2522 012 98025	SCREW M4 X 12	4
15	5107 010 02791	SCREW HEX WHD M4 X 8	6
16	5107 010 02621	KEPS NUT M4	3
17	2422 034 11482	TAB	1
18	5107 190 13170	MAIN PCB ASSEMBLY	1
19		CHASSIS ASSEMBLY	1
20	2422 086 00476	FUSE, 2.0A SLOW-BLOW	1
21	5107 190 13190	REAR PANEL ASSEMBLY	1
22	5107 120 03450	TOP SCREEN	1
23	5107 010 02791	SCREW HEX WHD M4 X 8	6
24	5107 130 05140	REAR COVER	1
25	2522 012 11076	SCREW M4 X 25	4
26	5107 130 05700	NAME PLATE	1
27			
28	5107 100 09550	LABEL, DATE & SERIAL #	1
29	0707 210 00050	VIDEO CABLE	1
30*	2438 070 98019	AC LINE CORD	1
31*	5107 991 05550	USER MANUAL	1
32*	5107 991 05560	WARRANTY CARD	1

REMARK: THIS IS A SUPPLIMENTAL SHEET FOR THE ASSEMBLY
DRAWING 5107 102 06741, SHEET 1 OF 2 (IN "B"
OR "D" SIZE)

*: FOR "LOON" MODEL ONLY.

REV

TITLE

SERVICE MANUAL
MODEL: M19P114P/7103

PART NO.

5107 991 05491

SHEET

60A OF 79

ITEM	PART NUMBER	DESCRIPTION	Q'TY
1	5105 155 00540	CRT	1
2	2507 200 03033	SCREW M5 X 12	4
3	2507 601 98018	WASHER	4
4	5107 190 12970	LED PCB ASSY	1
5	2507 001 04009	SCREW #6 X 1/4"	1
6	5107 190 12460	BASE ASSEMBLY	1
7	5107 190 12130	YOKE ASSEMBLY	1
8	5107 130 05600	LOGO	1
9	5107 190 13180	VIDEO ASSEMBLY	1
10	5107 190 13150	BEZEL ASSEMBLY	1
11	5107 001 03043	SCREW #8 X 1 1/4"	8
12	5107 190 12140	CABLE ASSEMBLY DC	1
13	2507 200 03021	SCREW M4 X 8	3
14	2522 012 98025	SCREW M4 X 12	4
15	5107 010 02791	SCREW HEX WHD M4 X 8	6
16	5107 010 02621	KEPS NUT M4	3
17	2422 034 11482	TAB	1
18	5107 190 13170	MAIN PCB ASSEMBLY	1
19		CHASSIS ASSEMBLY	1
20	2422 086 00476	FUSE, 2.0A SLOW-BLOW	1
21	5107 190 13190	REAR PANEL ASSEMBLY	1
22	5107 120 03450	TOP SCREEN	1
23	5107 010 02791	SCREW HEX WHD M4 X 8	6
24	5107 130 05140	REAR COVER	1
25	2522 012 11076	SCREW M4 X 25	4
26	5107 130 05700	NAME PLATE	1
27			
28	5107 100 09550	LABEL, DATE & SERIAL #	1
29	0707 210 00050	VIDEO CABLE	1
30*	2438 070 98019	AC LINE CORD	1
31*	5107 991 05550	USER MANUAL	1
32*	5107 991 05560	WARRANTY CARD	1

REMARK: THIS IS A SUPPLIMENTAL SHEET FOR THE ASSEMBLY
DRAWING 5107 102 06741, SHEET 1 OF 2 (IN "B"
OR "D" SIZE)

*: FOR "LOON" MODEL ONLY.

REV
A

AUTORISATION ECRITE DU PROPRIETAIRE.

ELECTRONIC DISPLAY



TITLE

SERVICE MANUAL
MODEL: M19P114P/7103

PART NO.

5107 991 05491

SHEET

61 OF 79

PACKING DIAGRAM

TOP

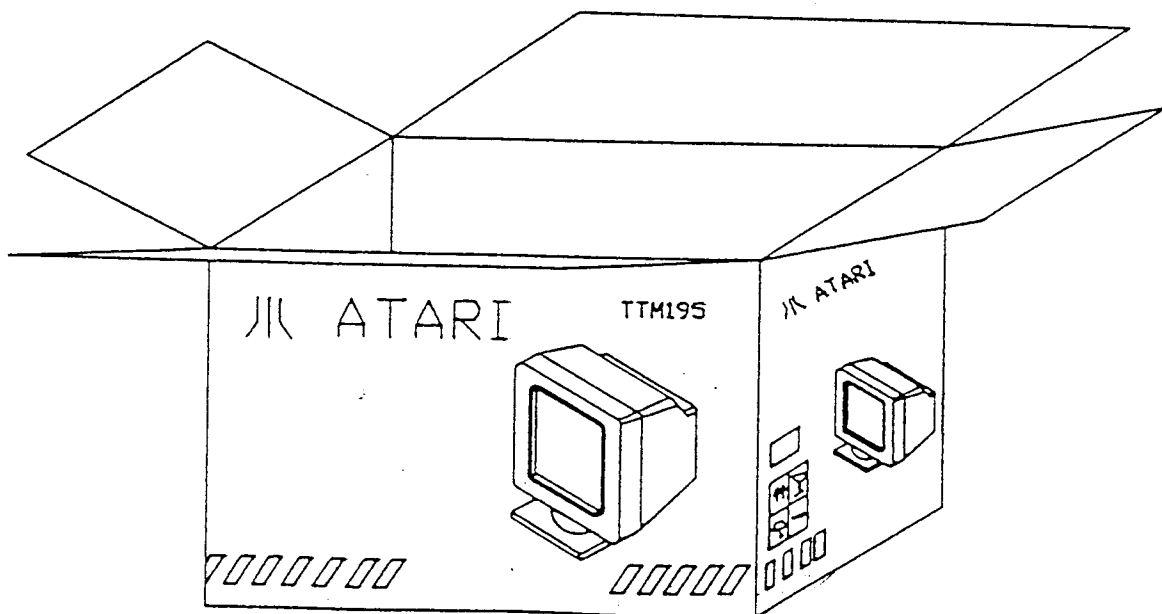
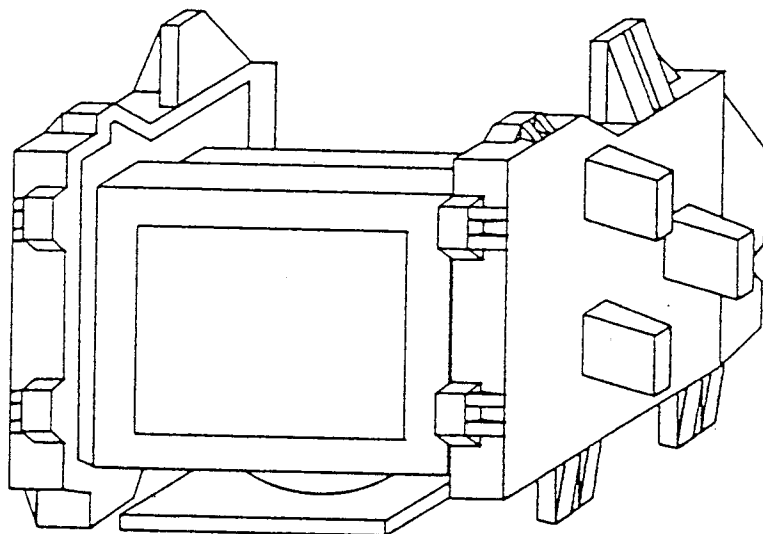

REV

TITLE

SERVICE MANUAL
MODEL: M19P114P/7103

PART NO.

5107 991 05491

SHEET

62

OF

79

SECTION 12REPLACEMENT PARTS LIST

12.1.1 Main PCB Assembly, 5107 190 13172

REFERENCE DESIGNATION	DESCRIPTION	PART NUMBER
CAPACITORS		
C 101	ELCO., 330uF, 20%, 400V	2020 021 90383
C 102	FILM., 10nF, 20%, 400V	2222 368 55103
C 103	CER., 22nF, -20% +80%, 63V	2222 629 19223
C 104	CER., 100pF, 20%, 3kV	5107 145 00022
C 105	M.F., 4n7, 20%, 250Vac	2031 220 03005
C 130	ELCO., 470uF, 20%, 35V	2222 037 50471
C 131	ELCO., 330uF, 20%, 35V	2222 037 50331
C 132	FILM, 470uF, 10%, 63V	2222 365 14474
C 134	CER., 2n2F, 10%, 100V	2222 630 19222
C 135	FILM, 470uF, 10%, 63V	2222 365 14474
C 136	ELCO., 33uF, 20%, 16V	2222 037 55339
C 137	ELCO., 33uF, 20%, 16V	2222 037 55339
C 138	CER., 22nF, -20% +80%, 63V	2222 629 19223
C 139	CER., 2n2F, 10%, 100V	2222 630 19222
C 140	CER., 22nF, -20% +80%, 63V	2222 629 19223
C 141	FILM, 470uF, 10%, 63V	2222 365 14474
C 142	ELCO., 33uF, 20%, 16V	2222 037 55339

REV

TITLE

SERVICE MANUAL
MODEL: M19P114P/7103

PART NO.

5107 991 05491

SHEET

63

OF

79

REFERENCE DESIGNATION	DESCRIPTION	PART NUMBER
C 160	ELCO., 220uF, 20%, 100V	2222 037 59221
C 161	ELCO., 100uF, 20%, 100V	2222 037 59101
C 162	ELCO., 330uF, 20%, 35V	2222 037 50331
C 163	ELCO., 330uF, 20%, 35V	2222 037 50331
C 164	ELCO., 1000uF, 20%, 16V	2222 037 55102
C 165	FILM, 470uF, 10%, 63V	2222 365 14474
C 166	FILM, 10nF, 10%, 100V	2222 365 81103
C 167	FILM, 470nF, 20%, 100V	2222 365 20474
C 168	FILM, 470uF, 10%, 63V	2222 365 14474
C 169	FILM, 470uF, 10%, 63V	2222 365 14474
C 170	ELCO., 68uF, 20%, 6.3V	2222 037 53689
C 171	ELCO., 330uF, 20%, 35V	2222 037 50331
C 172	ELCO., 68uF, 20%, 6.3V	2222 037 53689
C 173	ELCO., 220uF, 20%, 100V	2222 037 59221
C 174	FILM, 4.7uF, 20%, 63V	2222 037 28478
C 175	FILM, 470uF, 10%, 63V	2222 365 14474
C 176	FILM, 470nF, 10%, 63V	2222 365 14474
C 201	CER., 1nF, 10%, 100V	2222 630 19102
C 202	FILM, 100nF, 20%, 63V	2222 370 10104
C 203	FILM, 100nF, 20%, 63V	2222 370 10104
C 204	FILM, 100nF, 20%, 63V	2222 370 10104
C 205	ELCO., 100uF, 25V	2222 035 26101
C 206	CER., 1n0F, 10%, 500V	2222 655 19102
C 207	STYR., 2n0F, 1%, 63V	2222 424 42002
C 208	FILM., 22nF, 10%, 63V	2222 370 21223
C 209	FILM, 100nF, 20%, 63V	2222 370 10104

REV

TITLE

SERVICE MANUAL
MODEL: M19P114P/7103

PART NO.

5107 991 05491

SHEET

64

OF

79

REFERENCE DESIGNATION	DESCRIPTION	PART NUMBER
C 211	M.K.T., 330uF, 10%, 100V	2222 371 21334
C 212	STYR., 680pF, 2%, 630V	2222 427 36801
C 214	ELCO., 68uF, 20% 100V	2020 021 90422
C 215	M.K.P., 9n1, 3.5%, 2000V	2012 326 14421
C 216	MKP, 560nF, 5%, 250V	2222 357 52564
C 219	FILM, 1n5F, 10%, 400V	2222 368 55152
C 220	CER., 100pF, NPO, 100V	2222 683 10101
C 221	ELCO., 10uF, 20%, 250V	2020 012 92283
C 222	CER., 3n0F, 1600V	2022 550 00122
C 223	FILM, 10nF, 10%, 63V	2222 370 21103
C 224	CER., 3n0F, 1600V	2022 550 00122
C 230	FILM, 82nF, 5%, 630V	2222 376 62823
C 253	CER., 1n0F, 10%, 500V	2222 655 19102
C 254	FILM, 100nF, 20%, 63V	2222 370 10104
C 302	FILM., 22nF, 10%, 63V	2222 370 21223
C 303	FILM, 10nF, 10%, 100V	2222 370 21103
C 304	ELCO, 10uF, 20%, 63V	2222 037 28109
C 305	M.K.T., 470nF, 5%, 63V	2222 370 12474
C 306	VAR., 6-50pF, 50V, GMV	2020 800 00026
C 307	FILM, 100nF, 20%, 63V	2222 370 10104
C 308	ELCO., 100uF, 20%, 63V	2222 037 58101
C 309	ELCO., 1000uF, 20%, 50V	2222 037 51102
C 310	ELCO, 220uF, 20%, 50V	2222 037 51221
C 311	ELCO, 10uF, 20%, 63V	2222 037 28109
C 312	M.K.T., 470nF, 5%, 63V	2222 370 12474
C 313	STYR., 30100pF, 1%, 63V	2222 443 43103

REV

ELECTRONIC INDUSTRIES THE PROFITABLE

TITLE

SERVICE MANUAL
MODEL: M19P114P/7103

PART NO.

5107 991 05491

SHEET

65 OF 79

REFERENCE DESIGNATION	DESCRIPTION	PART NUMBER
C 314	STYR., 30100pF, 1%, 63V	2222 443 43103
C 315	FILM, 22nF, 10%, 100V	2222 370 21223
C 316	ELCO, 1500uF, 20%, 25V	2222 037 56152
C 317	M.K.T., 330uF, 10%, 100V	2222 371 21334
C 318	ELCO, 1uF, 20%, 63V	2222 037 28108
C 320	CER., 120pF, 2%, 100V, NPO	2222 683 10121
C 401	ELCO, 10uF, 20%, 63V	2222 037 28109
C 402	ELCO, 10uF, 20%, 63V	2222 037 28109
C 403	FILM, 330nF, 10%, 250V	2222 368 45334
C 404	CER., 1n0F, 10%, 500V	2222 655 19102
C 501	FILM, 220nF, 5%, 63V	2222 370 12224
C 502	FILM, 470nF, 20%, 63V	2222 370 10474
C 503	FILM, 470nF, 20%, 63V	2222 370 10474
C 505	M.K.T., 470nF, 10%, 63V	2222 370 11474
C 506	STYRNE, 430pF, 2%, 630V	2222 427 34301
C 507	STYRNE, 470pF, 2%, 630V	2222 427 34701
C 508	CER., 220pF, 20%, 3kV	2235 559 00085
C 509	FILM, 68nF, 10%, 630V	2222 368 65683
C 510	CER., 220pF, 20%, 3kV	2235 559 00085
C 511	CER., 220pF, 20%, 3kV	2235 559 00085
C 513	FILM, 100nF, 20%, 100V	2222 368 24104
C 701	FILM, 33nF, 20%, 100V	2222 367 84333
C 702	FILM, 100uF, 20%, 16V	2222 037 25101
C 703	FILM, 100nF, 20%, 63V	2222 370 10104

REV

TITLE

SERVICE MANUAL
MODEL: M19P114P/7103

PART NO.

5107 991 05491

SHEET

66

OF

79

REFERENCE DESIGNATION	DESCRIPTION	PART NUMBER
RESISTORS		
R 102	SFR16T, 100R, 5%, 0.5W	2322 180 83101
R 103	PR03, 27K, 5%, 3W	2322 195 13273
R 104	SFR16T, 10R, 5%, 0.5W	2322 180 83109
R 106	W.W., OR22, 5%, 2.0W	2122 251 01345
R 110	PR03, 2K4, 5%, 3W	2322 195 13242
R 113	SFR16T, 100R, 5%, 0.5W	2322 180 83101
R 121	SFR16T, 120R, 5%, 0.5W	2322 180 83121
R 130	SFR16T, 120R, 5%, 0.5W	2322 180 83121
R 131	SFR16T, 120R, 5%, 0.5W	2322 180 83121
R 132	SFR16T, 47R, 5%, 0.5W	2322 180 83479
R 133	SFR16T, 14K, 5%, 0.5W	2322 187 31403
R 135	SFR16T, 1K5, 5%, 0.5W	2322 180 83152
R 136	SFR16T, 4K7, 5%, 0.5W	2322 180 83472
R 137	SFR16T, 4K7, 5%, 0.5W	2322 180 83472
R 138	SFR16T, 100R, 5%, 0.5W	2322 180 83101
R 139	SFR16T, 47R, 5%, 0.5W	2322 180 83479
R 140	SFR16T, 2K2, 5%, 0.5W	2322 180 83222
R 141	SFR16T, 2K7, 5%, 0.5W	2322 180 83272
R 142	SFR16T, 4K7, 5%, 0.5W	2322 180 83472
R 143	SFR16T, 30R, 5%, 0.5W	2322 180 83309
R 144	SFR16T, 470R, 5%, 0.5W	2322 180 83471
R 160	SFR16T, 1K0, 5%, 0.5W	2322 180 83102
R 161	SFR16T, 510K, 5%, 0.5W	2322 180 83514
R 162	SFR16T, 750R, 5%, 0.5W	2322 180 83751
R 163	SFR16T, 5K1, 5%, 0.5W	2322 180 83512

REV

AUTOMATION SYSTEMS

THE PROPRIETOR

ELECTRONIC SYSTEMS

TITLE

SERVICE MANUAL
MODEL: M19P114P/7103

PART NO.

5107 991 05491

SHEET

67

OF

79

REFERENCE DESIGNATION	DESCRIPTION	PART NUMBER
R 164	SFR16S, 20K, 1%, 0.5W	2322 187 32003
R 165	VAR., 100R, 10%, 0.5W	2322 491 00101
R 166	SFR16S, 576R, 1%, 0.5W	2322 187 35761
R 167	SFR16T, 680R, 5%, 0.5W	2322 180 83681
R 168	PR03, 5R1, 5%, 3W	2322 195 13518
R 169	SFR16T, 10K, 5%, 0.5W	2322 180 83103
R 170	SFR16S, 47K, 1%, 0.5W	2322 187 34703
R 171	VAR., 200R, 10%, 0.5W	2322 491 00201
R 172	SFR16S, 1K3, 1%, 0.5W	2322 187 31302
R 173	SFR16S, 2K49, 1%, 0.5W	2322 187 32492
R 174	PR03, 4K7, 5%, 3.0W	2322 195 13472
R 175	SFR16T, 100R, 5%, 0.5W	2322 180 83101
R 176	SFR16S, 150R, 1%, 0.5W	2322 187 31501
R 177	SFR16S, 24R5, 1%, 0.5W	2322 187 32559
R 178	SFR16S, 100R, 1%, 0.5W	2322 187 31001
R 179	SFR16T, 24R, 5%, 0.5W	2322 180 83249
R 201	SFR16T, 1K 5%, 0.5W	2322 180 83102
R 202	SFR16T, 560R, 5%, 0.5W	2322 180 83561
R 203	SFR16T, 120R, 5%, 0.5W	2322 180 83121
R 204	SFR16T, 10K, 5%, 0.5W	2322 180 83103
R 205	SFR16T, 820R, 5%, 0.5W	2322 180 83821
R 207	SFR16T, 3K9, 5%, 0.5W	2322 180 83392
R 208	SFR16T, 82K, 5%, 0.5W	2322 180 83823
R 209	SFR16T, 12K, 5%, 0.5W	2322 187 83123
R 210	SFR16T, 8K2, 5%, 0.5W	2322 180 83822
R 211	SFR16T, 220R, 5%, 0.5W	2322 180 83221

REV

TITLE

SERVICE MANUAL
MODEL: M19P114P/7103

PART NO.

5107 991 05491

SHEET 68 OF 79

REFERENCE DESIGNATION	DESCRIPTION	PART NUMBER
R 216	SFR16T, 4R7, 5%, 0.5W	2322 180 83478
R 217	SFR16T, 820R, 5%, 0.5W	2322 180 83821
R 218	PR03, 3R3, 5%, 3W	2306 199 15368
R 219	PR03, 3R3, 5%, 3W	2306 199 15368
R 221	SFR16T, 1R0, 5%, 0.5W	2322 180 83108
R 223	SFR16T, 100R, 5%, 0.5W	2322 180 83101
R 224	PR03, 220R, 5%, 3W	2322 195 13221
R 225	SFR16T, 220K, 5%, 0.5W	2322 180 83224
R 226	SFR16T, 220K, 5%, 0.5W	2322 180 83224
R 227	SFR16T, 1M, 5%, 0.5W	2322 180 83105
R 228	SFR16T, 150K, 5%, 0.5W	2322 180 83154
R 229	VAR., 22K, 10%, 0.5W	2322 482 42223
R 230	VAR., 4K7, 10%, 0.5W	2322 482 42472
R 231	SFR16T, 2K2, 5%, 0.5W	2322 180 83222
R 240	VR37, 470K, 5%, 0.5W	2322 242 23474
R 241	SFR16T, 2K2, 5%, 0.5W	2322 180 83222
R 242	SFR16T, 220R, 5%, 0.5W	2322 180 83221
R 243	SFR16T, 470R, 5%, 0.5W	2322 180 83471
R 244	SFR16T, 2K2, 5%, 0.5W	2322 180 83222
R 245	SFR16T, 100R, 5%, 0.5W	2322 180 83101
R 246	PR02, 8R2, 5%, 2W	2322 194 13828
R 247	PR02, 8R2, 5%, 2W	2322 194 13828
R 248	NOT USED	
R 249	NOT USED	
R 251	SFR 16T, 10K, 5%, 0.5W	2322 180 83103
R 253	SFR16T, 10K, 5%, 0.5W	2322 180 83103
R 255	SFR16T, 10K, 5%, 0.5W	2322 180 83103

REV

AUTORISATION ECRITE DU PROPRIETAIRE.

THE PROPRIETOR.

ELECTRONIC DISPLAY

TITLE

SERVICE MANUAL
MODEL: M19P114P/7103

PART NO.

5107 991 05491

SHEET

69

OF

79

REFERENCE DESIGNATION	DESCRIPTION	PART NUMBER
R 304	SFR16T, 120K, 5%, 0.5W	2322 180 83124
R 305	SFR16T, 47K, 5%, 0.5W	2322 180 83473
R 306	SFR16T, 4K7, 5%, 0.5W	2322 180 83472
R 307	SFR16T, 27K, 5%, 0.5W	2322 180 83273
R 308	SFR16T, 330K, 5%, 0.5W	2322 180 83334
R 309	SFR25H, 10M, 5%, 0.5W	2322 186 13106
R 310	SFR16T, 3R3, 5%, 0.5W	2322 180 83338
R 311	SFR16T, 470R, 5%, 0.5W	2322 180 83471
R 312	VAR., 100K, 10%, 0.5W	2322 482 42104
R 313	SFR16T, 36K, 5%, 0.5W	2322 180 83363
R 314	PR02, 10R, 5%, 2W	2322 194 13109
R 315	SFR16T, 120K, 5%, 0.5W	2322 180 83124
R 316	SFR16T, 20K, 5%, 0.5W	2322 180 83203
R 317	SFR16T, 100K, 5%, 0.5W	2322 180 83104
R 318	SFR16T, 110K, 5%, 0.5W	2322 180 83114
R 319	SFR16T, 120K, 5%, 0.5W	2322 180 83124
R 321	SFR16T, 10R, 5%, 0.5W	2322 180 83109
R 323	SFR16T, 1R0, 5%, 0.5W	2322 180 83108
R 324	MRS., 750K, 1%, 0.4W	2322 157 37504
R 325	SFR16T, 1K5, 5%, 0.5W	2322 180 83152
R 326	SFR16T, 330R, 5%, 0.5W	2322 180 83331
R 329	VAR., 10K, 10%, 0.5W	2322 482 42103
R 330	SFR16T, 10K, 5%, 0.5W	2322 180 83103
R 331	SFR16T, 39K, 5%, 0.5W	2322 180 83393
R 332	SFR16T, 470R, 5%, 0.5W	2322 180 83471
R 333	VAR., 100K, 10%, 0.5W	2322 482 42104
R 334	SFR16T, 180R, 5%, 0.5W	2322 180 83181

REV

TITLE

SERVICE MANUAL
MODEL: M19P114P/7103

PART NO.

5107 991 05491

SHEET 70 OF 79

R 335	VAR., 100K, 10%, 0.5W	2322 482 42104
R 336	SFR16T, 10K, 5%, 0.5W	2322 180 83103
R 341	PR03, 120R, 5%, 3W	2322 195 13121
R 342	PR03, 120R, 5%, 3W	2322 195 13121
R 343	SFR16T, 150R, 5%, 0.5W	2322 180 83151
R 344	SFR16T, 150R, 5%, 0.5W	2322 180 83151
R 345	SFR25, 4M7, 5%, 0.5W	2322 186 13475
R 346	SFR16T, 33K, 5%, 0.5W	2322 180 83333
R 347	SFR16T, 33K, 5%, 0.5W	2322 180 83333
R 348	SFR16T, 56K, 5%, 0.5W	2322 180 83563
R 349	SFR16T, 56K, 5%, 0.5W	2322 180 83563
R 401	SFR16T, 10K, 5%, 0.5W	2322 180 83103
R 402	SFR16T, 470K, 5%, 0.5W	2322 180 83471
R 403	SFR16T, 10K, 5%, 0.5W	2322 180 83103
R 404	SFR16T, 2K2, 5%, 0.5W	2322 180 83222
R 405	SFR16T, 2K2, 5%, 0.5W	2322 180 83222
R 406	SFR16T, 33K, 5%, 0.5W	2322 180 83333
R 407	SFR16T, 100K, 5%, 0.5W	2322 180 83104
R 408	SFR16T, 47K, 5%, 0.5W	2322 180 83473
R 409	SFR16T, 47K, 5%, 0.5W	2322 180 83473
R 410	VAR., 1M, 10%, 0.5W	2322 482 42105
R 411	SFR16T, 220K, 5%, 0.5W	2322 180 83224
R 412	SFR16T, 6K6, 5%, 0.5W	2322 180 83682
R 413	SFR16T, 220K, 5%, 0.5W	2322 180 83224
R 414	SFR., 1M, 5%, 0.5W	2322 180 83105
R 415	SFR16T, 220K, 5%, 0.5W	2322 180 83224
R 416	VAR., 1M, 10%, 0.5W	2322 482 42105
R 501	SFR16T, 1K5, 5%, 0.5W	2322 180 83152

REV

AUTORISATION ECRITE DU PROPRIETAIRE.

ELECTRONIC DISPLAY

ELECTRONIC DISPLAY

TITLE

SERVICE MANUAL
MODEL: M19P114P/7103

PART NO.

5107 991 05491

SHEET

71

OF

79

REFERENCE DESIGNATION	DESCRIPTION	PART NUMBER
R 503	VAR., 10K, 10%, 0.5W	2322 482 42103
R 504	VAR., 10K, 10%, 0.5W	2322 482 42103
R 505	SFR16T, 8K2, 5%, 0.5W	2322 180 83822
R 506	VAR., 10K, 10%, 0.5W	2322 482 42103
R 508	SFR16T, 47K, 5%, 0.5W	2322 180 83473
R 509	SFR16T, 56K, 5%, 0.5W	2322 180 83563
R 510	SFR16T, 47K, 5%, 0.5W	2322 180 83473
R 511	PR02, 33R, 5%, 2W	2322 194 13339
R 512	SFR16T, 47K, 5%, 0.5W	2322 180 83473
R 513	SFR16T 22K, 5%, 0.5W	2322 180 83223
R 514	SFR16T, 18K, 5%, 0.5W	2322 180 83183
R 515	VR37, 470K, 5%, 0.5W	2322 242 23474
R 516	SFR25H, 330K, 5%, 0.5W	2322 186 13334
R 517	SFR25H, 330K, 5%, 0.5W	2322 186 13334
R 518	VR25., 4M7, 5%, 0.25W	2322 241 23475
R 520	SFR25H, 330K, 5%, 0.5W	2322 186 13334
R 521	MRS25., 330K, 1%, 0.6W	2322 156 33304
R 522	VAR., 47K, 10%, 0.5W	2322 482 42473
R 523	SFR16T, 100K, 5%, 0.5W	2322 180 83104
R 524	VR25., 4M7, 5%, 0.25W	2322 241 23475
R 528	MRS25., 330K, 1%, 0.6W	2322 156 33304
R 529	MRS25., 330K, 1%, 0.6W	2322 156 33304
R 531	SFR16T, 6K8, 5%, 0.5W	2322 180 83682
R 532	PR02, 33R, 5%, 2W	2322 194 13339
R 533	SFR16T, 1M, 5%, 0.5W	2322 180 83105
R 534	MRS25., 47K, 1%, 0.6W	2322 156 34703

REV

REFERENCE DESIGNATION	DESCRIPTION	PART NUMBER
R 535	MRS25., 120K, 1%, 0.6W	2322 156 31204
R 536	MRS, 68K, 1%, 0.4W	2322 157 36803
R 537	MRS16T., 13K, 1%, 0.4W	2322 157 31303
R 538	C.C., 10K, 10%, 0.5W	2122 102 00692
R 539	SFR16T, 1M, 5%, 0.5W	2322 180 83105
R 540	SFR16T, 6K8, 5%, 0.5W	2322 180 83682
R 541	VR25J, 680K, 5%, .25W	2322 241 23684
R 542	VR25J, 1M5, 5%, .25W	2322 241 23155
R 701	MRS16T., 33K, 1%, 0.4W	2322 157 33303
R 702	MRS25., 820K, 1%, 0.6W	2322 156 38204
R 703	MRS25., 820K, 1%, 0.6W	2322 156 38204
R 704	MRS25., 820K, 1%, 0.6W	2322 156 38204
R 705	SFR16T, 2K2, 5%, 0.5W	2322 180 83222
R 706	SFR16T, 5K6, 5%, 0.5W	2322 180 83562
R 707	SFR16T, 10K, 5%, 0.5W	2322 180 83103
R 708	SFR16T, .15K, 5%, 0.5W	2322 180 83153
RT 100	THERMISTOR, 47 OHM @ 25 C	2122 612 00016
RT 101	THERMISTOR, 5K OHM @ 25 C	2122 660 02001
DIODES		
CR 102	1N4148	9330 839 90113
CR 103	BYV26E	9337 037 00113
CR 104	BYV26E	9337 037 00113
CR 105	BYV26-B	9336 534 90113
CR 106	G4J, 600V, 3A	9338 999 30682
CR 107	G4J, 600V, 3A	9338 999 30682
CR 108	G4J, 600V, 3A	9338 999 30682
CR 109	G4J, 600V, 3A	9338 999 30682

REV

THE PROPRIETOR

TITLE

SERVICE MANUAL
MODEL: M19P114P/7103

PART NO.

5107 991 05491

SHEET 73 OF 79

REFERENCE DESIGNATION	DESCRIPTION	PART NUMBER
CR 130	BYV26-B	9336 534 90113
CR 131	1N4148	9330 839 90113
CR 132	1N4148	9330 839 90113
CR 133	1N4148	9330 839 90113
CR 160	BYW-95C	9335 001 50153
CR 161	BYW-95C	9335 001 50153
CR 162	BYV28-200	9335 536 10153
CR 163	BYV28-200	9335 536 10153
CR 164	BYV28-200	9335 536 10153
CR 167	1N4148	9330 839 90113
CR 169	1N4004 GP	9338 386 50682
CR 201	1N4148	9330 839 90113
CR 202	1N4148	9330 839 90113
CR 203	BYV28-200	9335 536 10153
CR 204	BY329-1200	9337 034 10127
CR 205	NOT USED	
CR 206	BYV26B	9336 534 90113
CR 207	BY505	9336 363 30113
CR 208	BYV26E	9337 037 00113
CR 209	NOT USED	
CR 211	1N4148	9330 839 90113
CR 212	1N4148	9330 839 90113
CR 301	1N4148	9330 839 90113
CR 302	1N4004 GP	9338 386 50682
CR 303	1N4148	9330 839 90113
CR 304	1N4148	9330 839 90113
CR 401	1N4004 GP	9338 386 50682

KEY

REFERENCE DESIGNATION	DESCRIPTION	PART NUMBER
CR 402	1N4004 GP	9338 386 50682
CR 403	1N4004 GP	9338 386 50682
CR 501	BY505	9336 363 30113
CR 702	1N4148	9330 839 90113

ZENER DIODES

VR 134	ZENER, BZT03-C20, 20V, 5%, 1.3W	9336 015 80153
VR 135	ZENER, BZX79C10, 10V, 5%, 500mW	9331 177 90113
VR 160	ZENER, BZX79B16, 16V, 2%, 500mW	9331 669 20113
VR 168	ZENER, BZX79C6V8, 6V8, 5%, 500mW	9331 177 50113
VR 302	ZENER, BZX79B13, 13V, 2%, 500mV	9331 669 00113
VR 303	ZENER, BZX79B13, 13V, 2%, 500mV	9331 669 00113
VR 401	ZENER, BZX79C12, 12V, 5%, 500mV	9331 178 10113
VR 501	ZENER, BZX79C15, 15V, 5%, 500mV	9331 178 30113
VR 505	ZENER, BZX79C15, 15V, 5%, 500mV	9331 178 30113

TRANSISTORS

Q 101	SCR, MCR218-8	9322 024 79682
Q 102	MOSFET, BUZ355	9332 012 27682
Q 130	TRANSISTOR, BC558	9331 977 30112
Q 131	TRANSISTOR, BC558	9331 977 30112
Q 132	TRANSISTOR, BC548	9331 976 40112
Q 160	TRANSISTOR, BC558	9331 977 30112
Q 161	TRANSISTOR, BDT61B	9335 264 60127
Q 201	TRANSISTOR, BC558	9331 977 30112
Q 202	TRANSISTOR, BC 548	9331 976 40112
Q 203	TRANSISTOR, BC 549	9331 976 80112
Q 205	MOSFET, IRF610	9337 673 20682

TITLE

SERVICE MANUAL
MODEL: M19P114P/7103

PART NO.

5107 991 05491

SHEET

75 OF

79

REFERENCE DESIGNATION	DESCRIPTION	PART NUMBER
Q 206	TRANSISTOR, BUW13A	9335 004 20112
Q 207	TRANSISTOR, BF 370	9335 447 20112
Q 208	TRANSISTOR, BF 370	9335 447 20112
Q 209	TRANSISTOR, BC558	9331 977 30112
Q 210	TRANSISTOR, BC 548	9331 976 40112
Q 211	TRANSISTOR, BC 548	9331 976 40112
Q 212	TRANSISTOR, BC 548	9331 976 40112
Q 302	TRANSISTOR, BC 548	9331 976 40112
Q 303	TRANSISTOR, BD 230	9331 603 80112
Q 304	TRANSISTOR, BD 231	9331 603 90112
Q 401	TRANSISTOR, BC 546	9332 055 20112
Q 402	TRANSISTOR, BC 546	9332 055 20112
Q 403	TRANSISTOR, BF 423	9332 593 60112
Q 404	TRANSISTOR, BF 423	9332 593 60112
Q 405	TRANSISTOR, BF 423	9332 593 60112
Q 406	TRANSISTOR, BF 423	9332 593 60112
Q 407	TRANSISTOR, BF 423	9332 593 60112
Q 408	TRANSISTOR, BF 423	9332 593 60112
Q 501	TRANSISTOR, BD 230	9331 603 80112
Q 502	MOSFET, IRF610	9337 673 20682
Q 503	TRANSISTOR, BUX 87	9332 715 70112
Q 505	MOSFET, MTP1N60	9332 012 28682
IC'S		
IC 130	IC, UC3842AN, PWM	9339 410 40682
IC 131	IC, MOC8101T, OPTO-ISOLATOR	9332 019 14682
IC 132	IC, H11NX513, OPTO-ISOLATOR	8207 100 13431

REV

TITLE

SERVICE MANUAL
MODEL: M19P114P/7103

PART NO.

5107 991 05491

SHEET

76

OF

79

REFERENCE DESIGNATION	DESCRIPTION	PART NUMBER
IC 160	IC, TL780-12C, 3-TERMINAL REGULATOR	8332 013 87682
IC 161	IC, MC7905ACT, 3-TERMINAL REGULATOR,	9332 020 25682
IC 162	IC, TL431 CLP	9336 460 30682
IC 163	IC, TL431 CLP	9336 460 30682
IC 164	LM317LZ, VOLTAGE REGULATOR	9338 221 50682
IC 201	IC, TL 081 CP	9332 106 79682
IC 202	IC, CD 4046 BE	9334 367 70682
IC 203	IC, MC74HCT86	9337 306 20682
IC 204	IC, MC78L05 ACP	9335 107 20682
IC 301	IC, TDA 2653A	9337 116 30112
IC 501	IC, LM 324N	9332 576 30682
IC 701	LM 393N	9334 010 80682

INDUCTORS, TRANSFORMERS

T 101	TRANSFORMER, SWITCH MODE	5107 140 04422
T 201	TRANSFORMER, LINE DRIVE	5107 140 04252
T 202	TRANSFORMER, FLYBACK	5107 140 04121
T 501	TRANSFORMER, DYNAMIC FOCUS	5107 140 04141
L 202	WIDTH COIL	5107 140 04181
L 203	LINEARITY COIL	5107 140 04111
L 205	HFS CORRECTION COIL	5107 140 04131
L 206	FERRITE BEAD	4312 020 31060
L 301	TOROIDAL COMMON MODE FILTER	5107 140 04101

MISCELLANEOUS

F 101	FUSE, 2.0A, SLOW-BLOW	2422 086 00476
	FUSEHOLDER, OGB031.8101	2432 088 00102
	HEATSINK, DEFLECTION	5107 120 03531

REV

TITLE

SERVICE MANUAL
MODEL: M19P114P/7103

PART NO.

5107 991 05491

SHEET 77 OF 79

REFERENCE DESIGNATION	DESCRIPTION	PART NUMBER
H 101	HEATSINK	2422 487 89628
H 102	HEATSINK	2422 487 89573
H 160	HEATSINK	2422 487 89628
H 161	HEATSINK	2422 487 89628
J 101	HEADER, 5 PINS, 0.156"	5107 142 00021
J 201	HEADER, 10 PINS	2422 025 09966
J 204	HEADER, 3 PIN, 0.1"	2422 025 09968
J 205	HEADER, 2 PINS 3 POS	2422 015 07064
J 208	WAFER ASSY. 3 POS.	5107 142 00063
J 301	WAFER ASSY. 3 POS.	5107 142 00063
J 307	HEADER, 2 PIN, 0.1"	8207 100 12011
J 401	HEADER, 3 PINS 0.1"	2422 025 09965
	SPRING CLIP FOR SOT-93	9330 288 60112
	INSULATING PAD (CR204)	5107 130 02311
	THERMAL COMPOUND (FOR IC 301)	1307 500 30201
	INSULATING PAD (Q102)	5107 130 05441
	INSULATING PAD (Q206)	5107 130 05251
C 225	NOT USED	
C 226	NOT USED	

REV

TITLE

SERVICE MANUAL
MODEL: M19P114P/7103

PART NO.

5107 991 05491

SHEET

78

OF

79

Video PCB Assembly, 5107 190 13181

REFERENCE DESIGNATION	DESCRIPTION	PART NUMBER
MISCELLANEOUS		
	PCB STUFFED WITH S.M.D. COMPONENTS	5107 190 13221
IC602	HYBRID	9322 008 71682
J 601	10 PIN RIGHT ANGLE POCKET HEADER	2422 025 09953
J 602	4 PIN RIGHT ANGLE HEADER	2422 023 98261
J 604	CRT SOCKET	2438 500 90001
J 605	CABLE ASSY CG/G4	5107 190 11871
J 606	CABLE ASSY CG/G4	5107 190 11871
	WIRE ASSY VIDEO GROUND	5107 190 12371
	CLAMP ASSY VIDEO MOUNTING	3322 602 00462
	SLEEVE, LOCK VIDEO MOUNTING	5107 130 05302
	SLEEVE, LOCK VIDEO MOUNTING	5107 130 05021
	SCREW 6-32 X 1/2" (FOR IC602 MTG. STAN	2507 200 01026
	CABLE STRAP	2422 015 05167
	HEATSINK EXTRUDED	5107 120 03512

REV

AMENDMENTS

ECO#	DESCRIPTION OF CHANGE	DATE
2237	CHANGE C136 FROM 2222 037 55339 33uF 16V TO 2322 037 50331 330uF 35V	91/04/09
	CHANGE C131 FROM 2222 037 50331 330uF 35V TO 2222 037 50471 470uF 35V	
	THESE COMPONENTS TO BE CHANGED ON THE PPL AND SCHEMATIC	
2264	VIDEO ASSY 5107 190 13221 PARTS LIST: DELETE C624 100nF, 100V (2020 557 90473); SG602, 603 PART NO. CHANGED FROM 2422 549 26019 TO 2422 549 41044	91/05/02
2407	REF. DESIGNATION FOR IC162 CORRECTED ON P.S. SCHEMATIC	91/11/19

=====

PRODUKT: TTM195
 Hi-Res Monitor für TT (Philips)
 19" Monochrom-Monitor

Bildröhre: 19 Zoll Diagonale,
 Phosphor P104 weiß, entspiegelt

Ablenkwinkel: 110°

Video-Eingang: ECL (Pixel Rate 128,94 MHz), 120 Ohm
 positives Signal => weiße Pixel

Zeilenfrequenz: ca. 72 kHz, HSYNC TTL "LO" aktiv,
 Eingangsimpedanz 1 kOhm

Bildfrequenz: ca. 72 Hz, VSYNC TTL "LO" aktiv,
 Eingangsimpedanz 1 kOhm

Auflösung: 1280 x 960 Bildpunkte, non-interlaced
 Anzeigebereich ca. 335 x 251 +/- 4 mm

Bedienungselemente: Helligkeit
 Ein/Aus (an der Rückseite)

Stromaufnahme: 110 / 220 V, <100W

Schwenkfuß: vorhanden

Abmessungen: 462 x 451,5 x 391 mm
 (B x H x T)

Gewicht: < 22,5 kg

Belegung des
 Steckers:
 (Sub-D 9pol.
 female)

Kontakt	Signal
1	+ECL Video
2	+ECL Video Abschirmung
3	Hor. Sync
4	Vert. Sync
5	-
6	-ECL Video
7	-ECL Video Abschirmung
8	Sync Abschirmung, Signalerde
9	Monitor-Erkennung (->Masse)

Multi-lingual Operator's Handbook liegt bei.

- Kopie der Specs an WK und HR am 13.4.
- Noch keine Fotos (Hinweis an HR 13.4.)

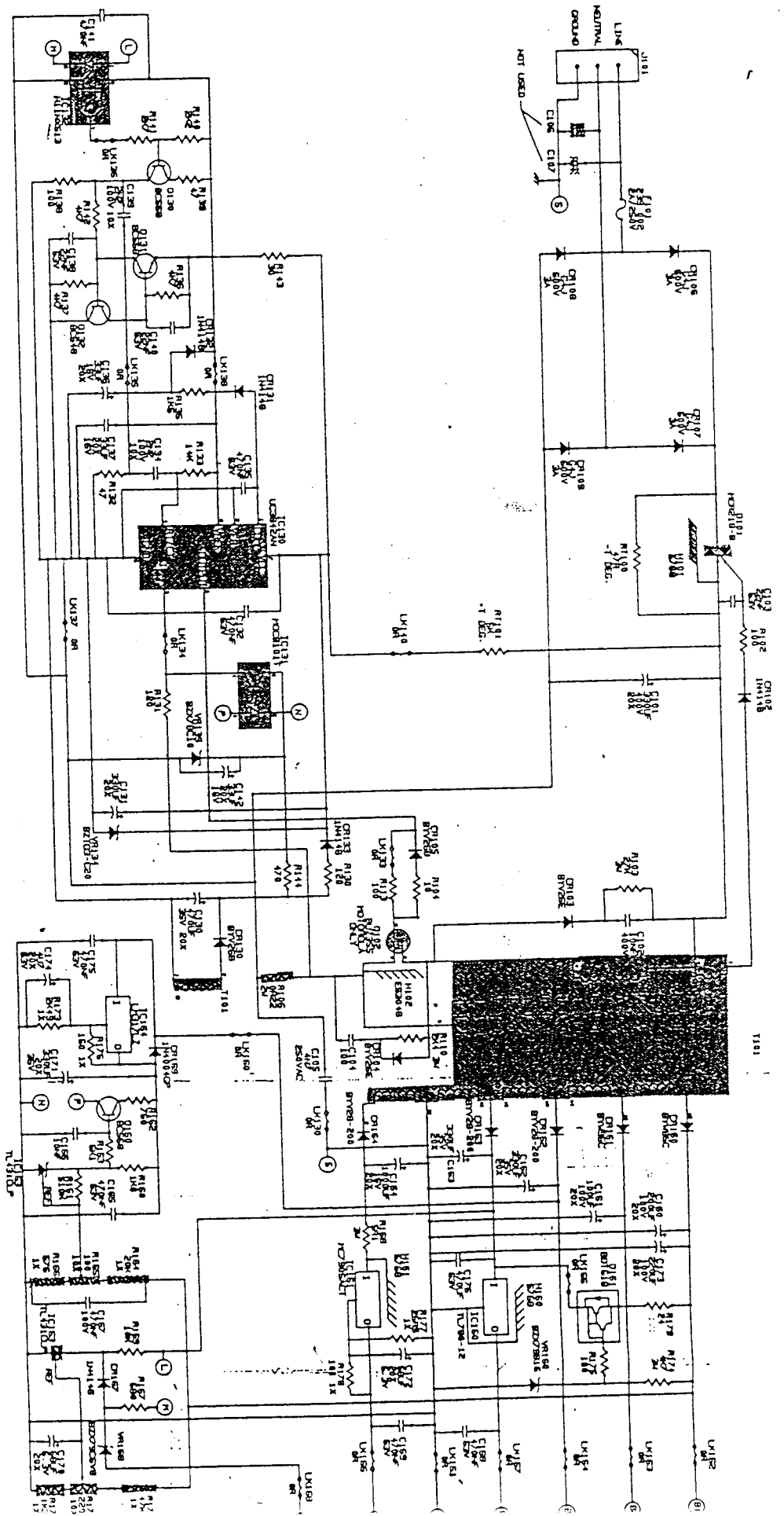

FOR THE CONTINUED SAFE OPERATION OF THIS PRODUCT, IT IS IMPERATIVE THAT COMPONENTS SHOWN IN THE SHADED AREAS BE REPLACED ONLY WITH THOSE SPECIFIED IN THE LIST OF THIS MANUAL. USE OF SUBSTITUTE REPLACEMENT PARTS, WHICH DO NOT HAVE THE SAME SAFETY CHARACTERISTICS AS THOSE SPECIFIED, MAY CREATE SHOCK, FIRE, X-RAY

REPAIR REQUIREMENTS - SAFETY PRECAUTIONS

FOR MAXIMUM RELIABILITY AND PERFORMANCE, ALL OTHER PARTS MUST BE REPLACED BY THOSE HAVING IDENTICAL SPECIFICATIONS. SEALED POTENTIALERS IN SHADED AREAS MUST BE RESEALED WITH APPROVED SEALANT AFTER FIELD ADJUSTMENT OR REPLACEMENT. UNDER NO CIRCUMSTANCES MAY THE ORIGINAL DESIGN BE MODIFIED OR ALTERED WITHOUT PERMISSION FROM PHILIPS ELECTRONICS LTD.

DO NOT RECALL	DATE
DATE	POWER

PHILIPS ELECTRONICS LTD.
 INCORPORATED IN CANADA
 PHILIPS ELECTRONICS LTD.
 4370 SHEPPARD AVENUE EAST
 SCARBOROUGH, ONTARIO M1S 1T7
 TEL: (416) 291-2100
 FAX: (416) 291-2101

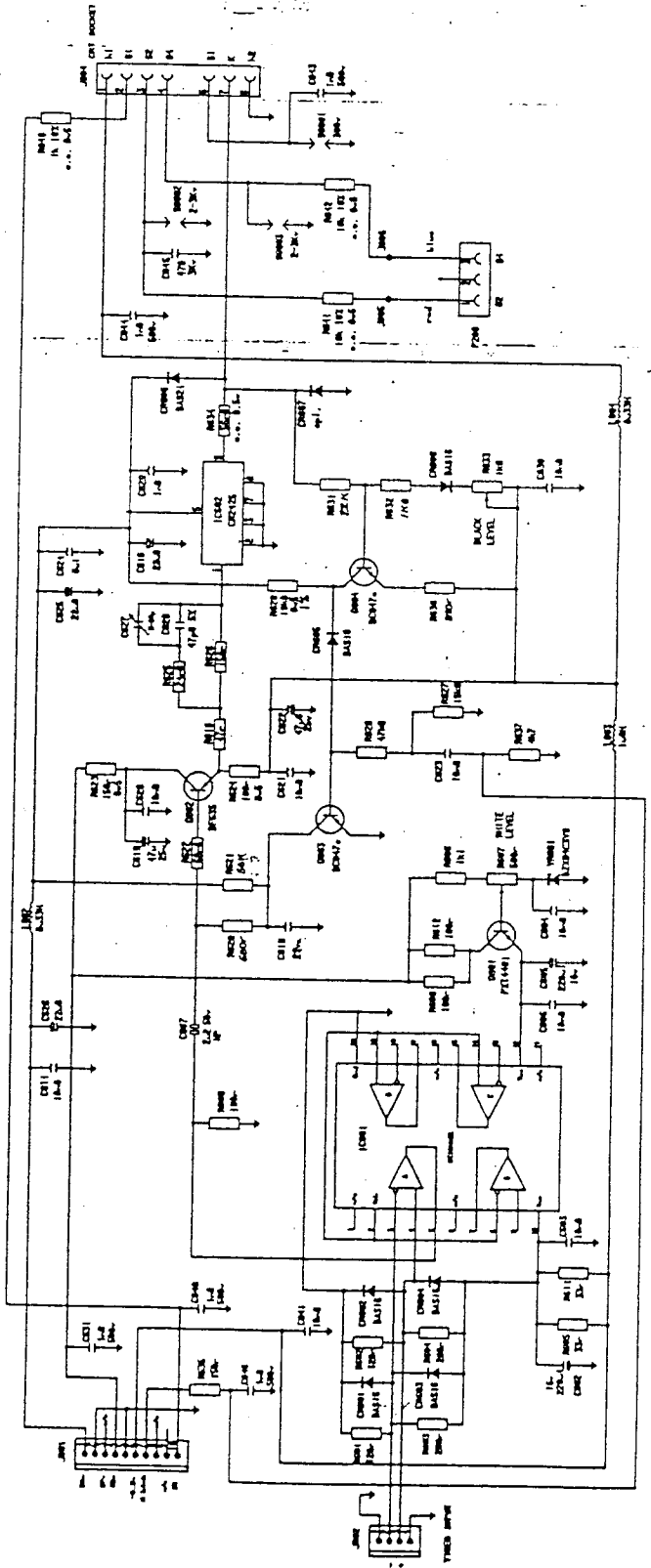

- NOTES:
1. UNLESS OTHERWISE SPECIFIED, RESISTOR VALUE IS OHMS, CAPACITOR VALUE IS μ F AND TOLERANCE IS 5%. CAPACITOR VALUE IN μ F AND TOLERANCE IS 5%, AND TOLERANCE IS 100P.
 2. \downarrow CIRCUIT INCLUDE.
 3. \uparrow CIRCUIT CONNECTION.
 4. \times NO CONNECTION.

PHILIPS ELECTRONICS LTD.
 INCORPORATED IN CANADA
 PHILIPS ELECTRONICS LTD.
 4370 SHEPPARD AVENUE EAST
 SCARBOROUGH, ONTARIO M1S 1T7
 TEL: (416) 291-2100
 FAX: (416) 291-2101

DATE: 1991-05-17
 DRAWN BY: J. J. J.
 CHECKED BY: J. J. J.
 APPROVED BY: J. J. J.

DO NOT SCALE

D

SCHEMATIC DIAGRAM
 ECL VIDEO PCR

5107 991 05491 A

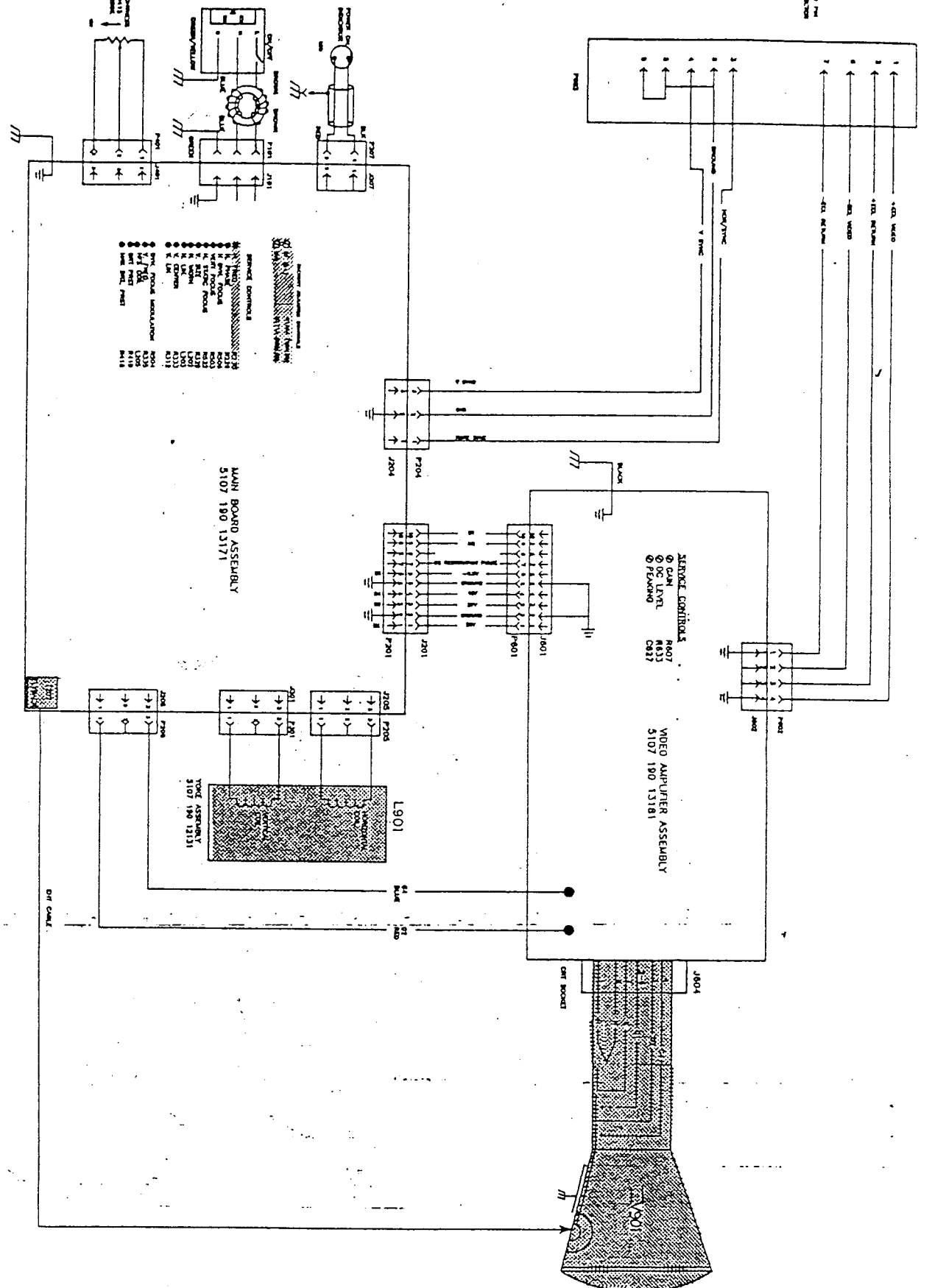

VOLTAGE ASSIGNMENT TABLE

Symbol	Voltage
B1	BY
B2	BY
B3	BY
B4	BY
B5	BY
B6	BY
B7	BY
B8	BY
B9	BY
B10	BY
B11	BY
B12	BY
B13	BY
B14	BY
B15	BY
B16	BY
B17	BY
B18	BY
B19	BY
B20	BY
B21	BY
B22	BY
B23	BY
B24	BY
B25	BY
B26	BY
B27	BY
B28	BY
B29	BY
B30	BY
B31	BY
B32	BY
B33	BY
B34	BY
B35	BY
B36	BY
B37	BY
B38	BY
B39	BY
B40	BY
B41	BY
B42	BY
B43	BY
B44	BY
B45	BY
B46	BY
B47	BY
B48	BY
B49	BY
B50	BY
B51	BY
B52	BY
B53	BY
B54	BY
B55	BY
B56	BY
B57	BY
B58	BY
B59	BY
B60	BY
B61	BY
B62	BY
B63	BY
B64	BY
B65	BY
B66	BY
B67	BY
B68	BY
B69	BY
B70	BY
B71	BY
B72	BY
B73	BY
B74	BY
B75	BY
B76	BY
B77	BY
B78	BY
B79	BY
B80	BY
B81	BY
B82	BY
B83	BY
B84	BY
B85	BY
B86	BY
B87	BY
B88	BY
B89	BY
B90	BY
B91	BY
B92	BY
B93	BY
B94	BY
B95	BY
B96	BY
B97	BY
B98	BY
B99	BY
B100	BY

IMPORTANT SAFETY NOTICE

CONTINUED SAFE OPERATION OF THIS PRODUCT, IT IS IMPERATIVE THAT THE PARTS SHOWN IN THE SHADED AREAS BE REPLACED ONLY WITH IDENTICAL PARTS. IN THE PARTS LIST OF THIS MANUAL, USE OF SUBSTITUTE PARTS, WHICH DO NOT HAVE THE SAME SAFETY CHARACTERISTICS SPECIFIED, MAY CREATE SHOCK, FIRE, X-RADIATION AND OTHER HAZARDS.

FOR MAXIMUM RELIABILITY AND PERFORMANCE, ALL OTHER PARTS MUST BE REPLACED BY THOSE HAVING IDENTICAL SPECIFICATIONS. SEALED POTENTIOMETERS IN SHADED AREAS MUST BE RESEALED WITH APPROVED SEALANT AFTER FIELD ADJUSTMENT OR REPLACEMENT. UNDER NO CIRCUMSTANCES MAY THE ORIGINAL DESIGN BE MODIFIED OR ALTERED WITHOUT PERMISSION FROM PHILIPS ELECTRONICS LTD.

PHILIPS ELECTRONICS LTD.
 SCHEMATIC SYSTEM
 5107 991 05471

FRONT VIEW

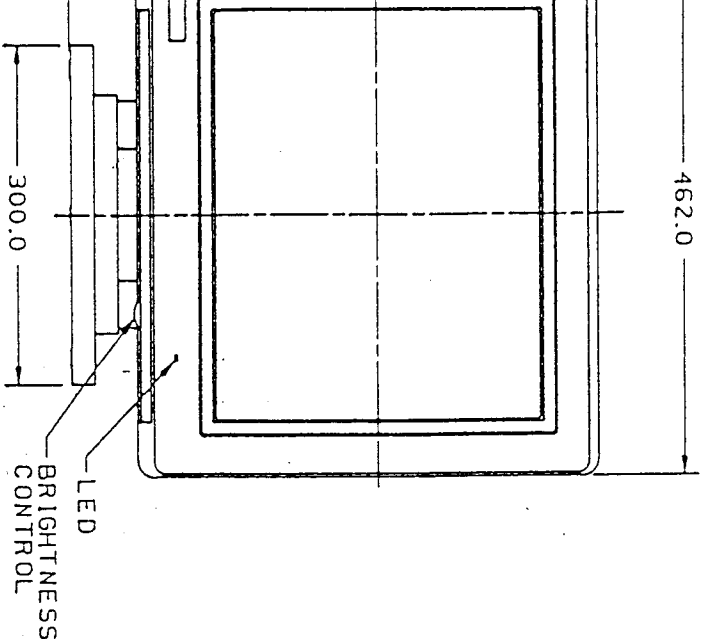

SIDE VIEW

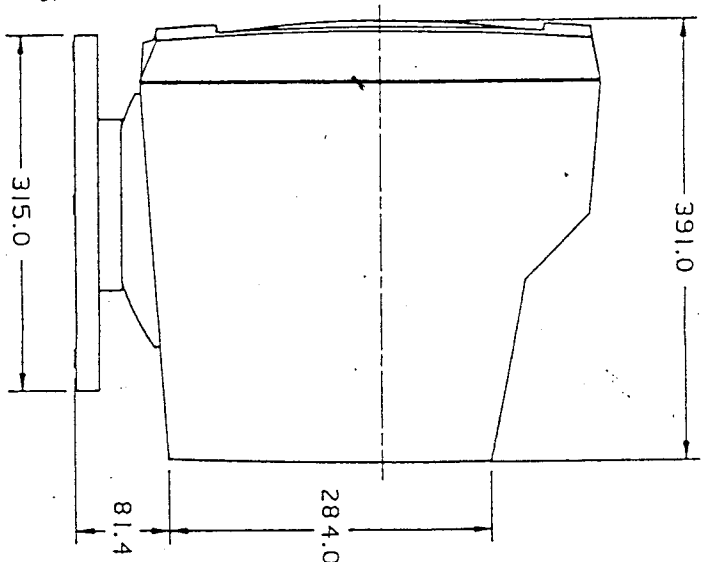

REAR VIEW

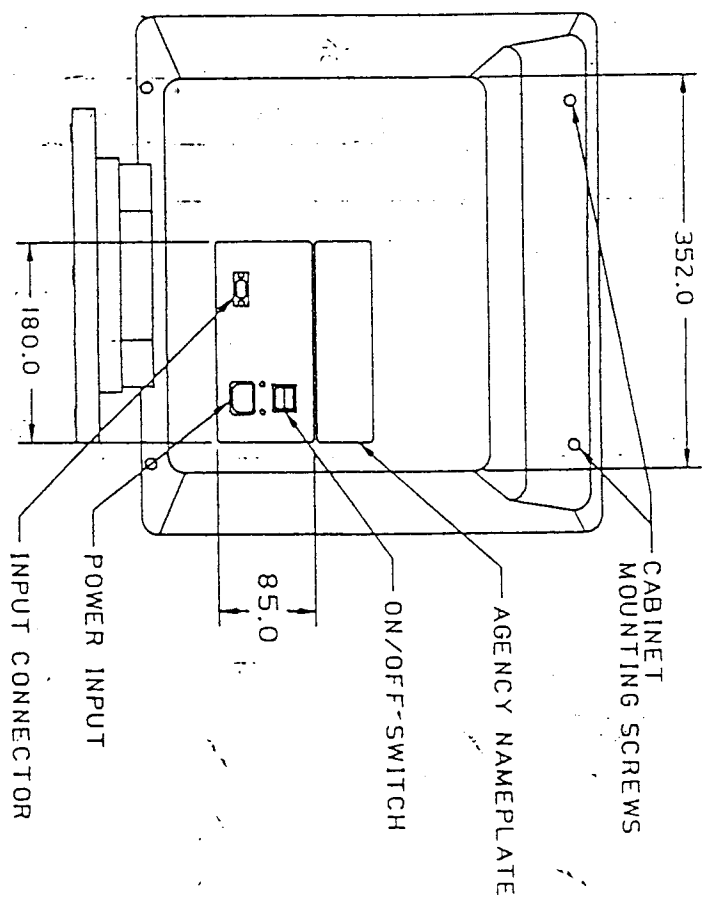

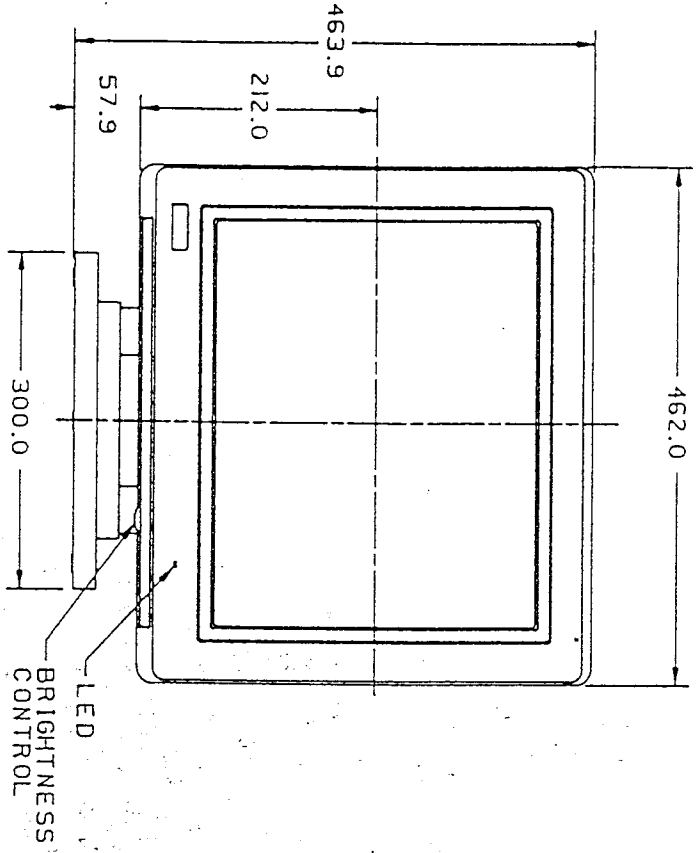

FRONT VIEW

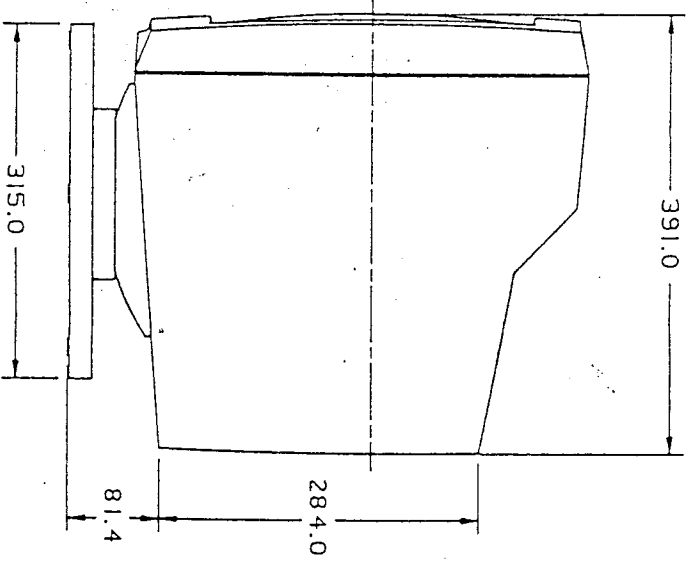

SIDE VIEW

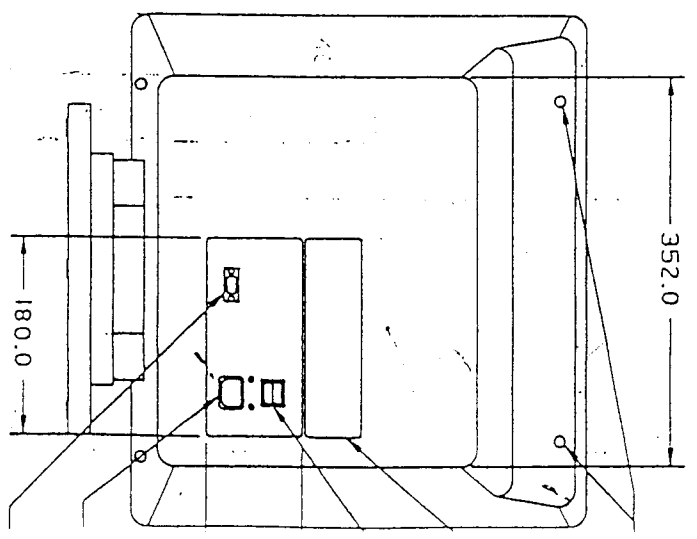

REAR VIEW

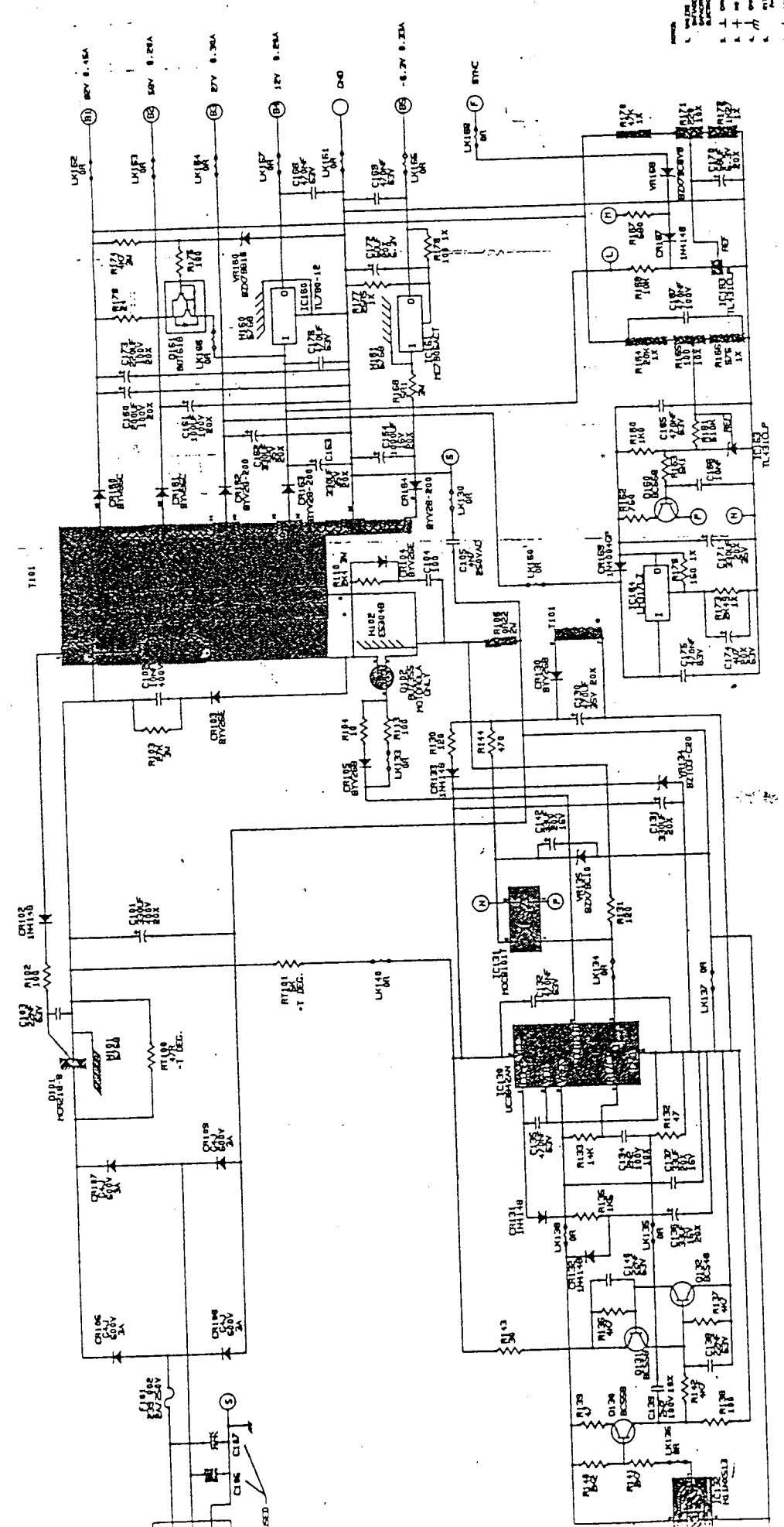

- 1. 1.0000
- 2. 1.0000
- 3. 1.0000
- 4. 1.0000
- 5. 1.0000
- 6. 1.0000
- 7. 1.0000
- 8. 1.0000
- 9. 1.0000
- 10. 1.0000

FOR THE CONTINUED SAFE OPERATION OF THIS PRODUCT, IT IS IMPERATIVE THAT COMPONENTS SHOWN IN THE SHADED AREAS BE REPLACED ONLY WITH THOSE SPECIFIED IN THE PARTS LIST OF THIS MANUAL. USE OF SUBSTITUTE REPLACEMENT PARTS, WHICH DO NOT HAVE THE SAME SAFETY CHARACTERISTICS AS THOSE SPECIFIED, MAY CREATE SHOCK, FIRE, X-RADIATION AND OTHER HAZARDS.

APPROVED FOR THE ORIGINAL DESIGNER

FOR MAXIMUM RELIABILITY AND PERFORMANCE, ALL OTHER PARTS MUST BE REPLACED BY THOSE HAVING IDENTICAL SPECIFICATIONS. SEALED POTENTIOMETERS IN SHADED AREAS MUST BE RESEALED WITH APPROVED SEALANT AFTER FIELD ADJUSTMENT OR REPLACEMENT. UNDER NO CIRCUMSTANCES MAY THE ORIGINAL DESIGN BE MODIFIED OR ALTERED WITHOUT PERMISSION FROM PHILIPS ELECTRONICS LTD.

PHILIPS ELECTRONICS LTD.	5107 991 05491
DESIGNED BY	PHILIPS ELECTRONICS LTD.
CHECKED BY	PHILIPS ELECTRONICS LTD.
DATE	PHILIPS ELECTRONICS LTD.
SCALE	PHILIPS ELECTRONICS LTD.
DO NOT SCALE	PHILIPS ELECTRONICS LTD.
D MAIN PCB POWER SUPPLY SCH. LOON	

REV	DATE	BY	CHKD
1			
2			
3			
4			
5			
6			
7			
8			
9			
10			
11			
12			
13			
14			
15			
16			
17			
18			
19			
20			
21			
22			
23			
24			
25			
26			
27			
28			
29			
30			
31			
32			
33			
34			
35			
36			
37			
38			
39			
40			
41			
42			
43			
44			
45			
46			
47			
48			
49			
50			
51			
52			
53			
54			
55			
56			
57			
58			
59			
60			
61			
62			
63			
64			
65			
66			
67			
68			
69			
70			
71			
72			
73			
74			
75			
76			
77			
78			
79			
80			
81			
82			
83			
84			
85			
86			
87			
88			
89			
90			
91			
92			
93			
94			
95			
96			
97			
98			
99			
100			

1. UNLESS OTHERWISE SPECIFIED, MULTIPLE AND/OR IN LINE AND CONNECTING VALUE OF 1 AND 1 ARE TO BE USED TO INDICATE.
2. CIRCUIT SYMBOLS TO BE USED.
3. CIRCUIT CONNECTIONS TO BE MADE.
4. NO DIMENSIONAL TOLERANCES TO BE USED.

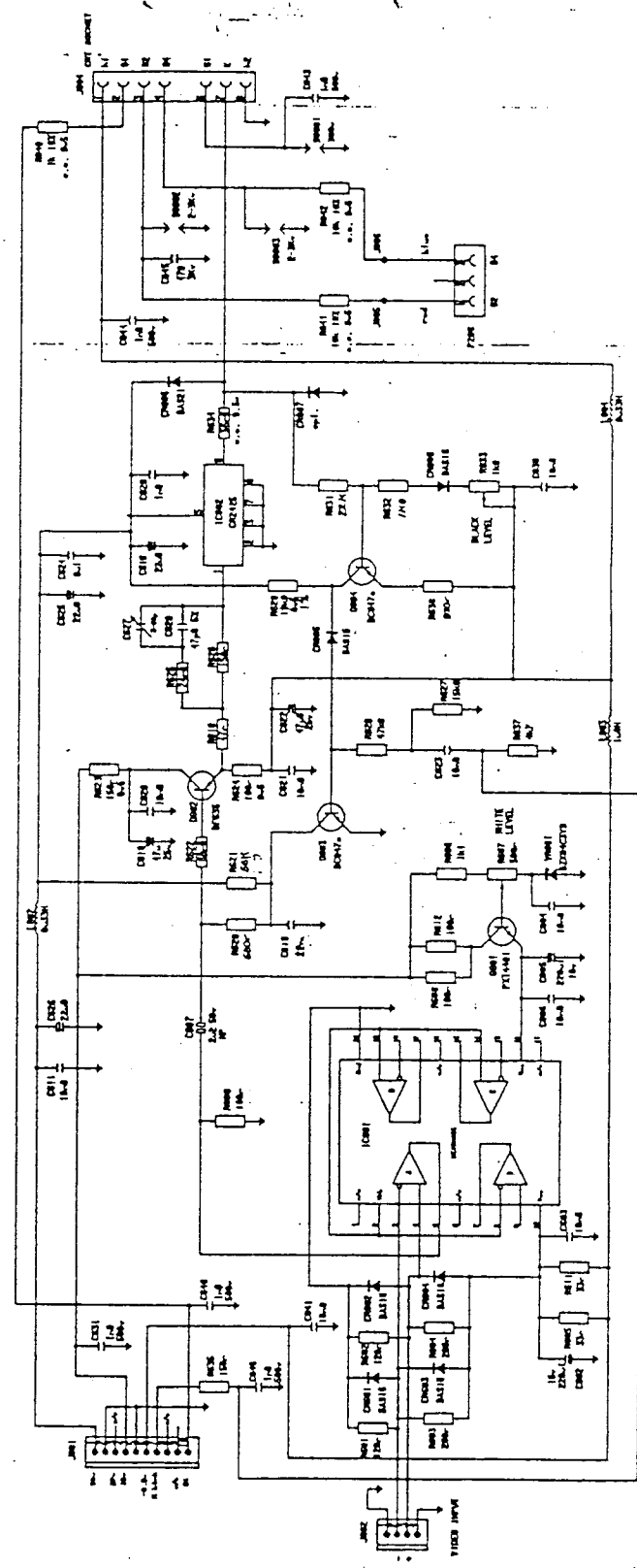

REV	DATE	BY	CHKD
1			
2			
3			
4			
5			
6			
7			
8			
9			
10			
11			
12			
13			
14			
15			
16			
17			
18			
19			
20			
21			
22			
23			
24			
25			
26			
27			
28			
29			
30			
31			
32			
33			
34			
35			
36			
37			
38			
39			
40			
41			
42			
43			
44			
45			
46			
47			
48			
49			
50			
51			
52			
53			
54			
55			
56			
57			
58			
59			
60			
61			
62			
63			
64			
65			
66			
67			
68			
69			
70			
71			
72			
73			
74			
75			
76			
77			
78			
79			
80			
81			
82			
83			
84			
85			
86			
87			
88			
89			
90			
91			
92			
93			
94			
95			
96			
97			
98			
99			
100			

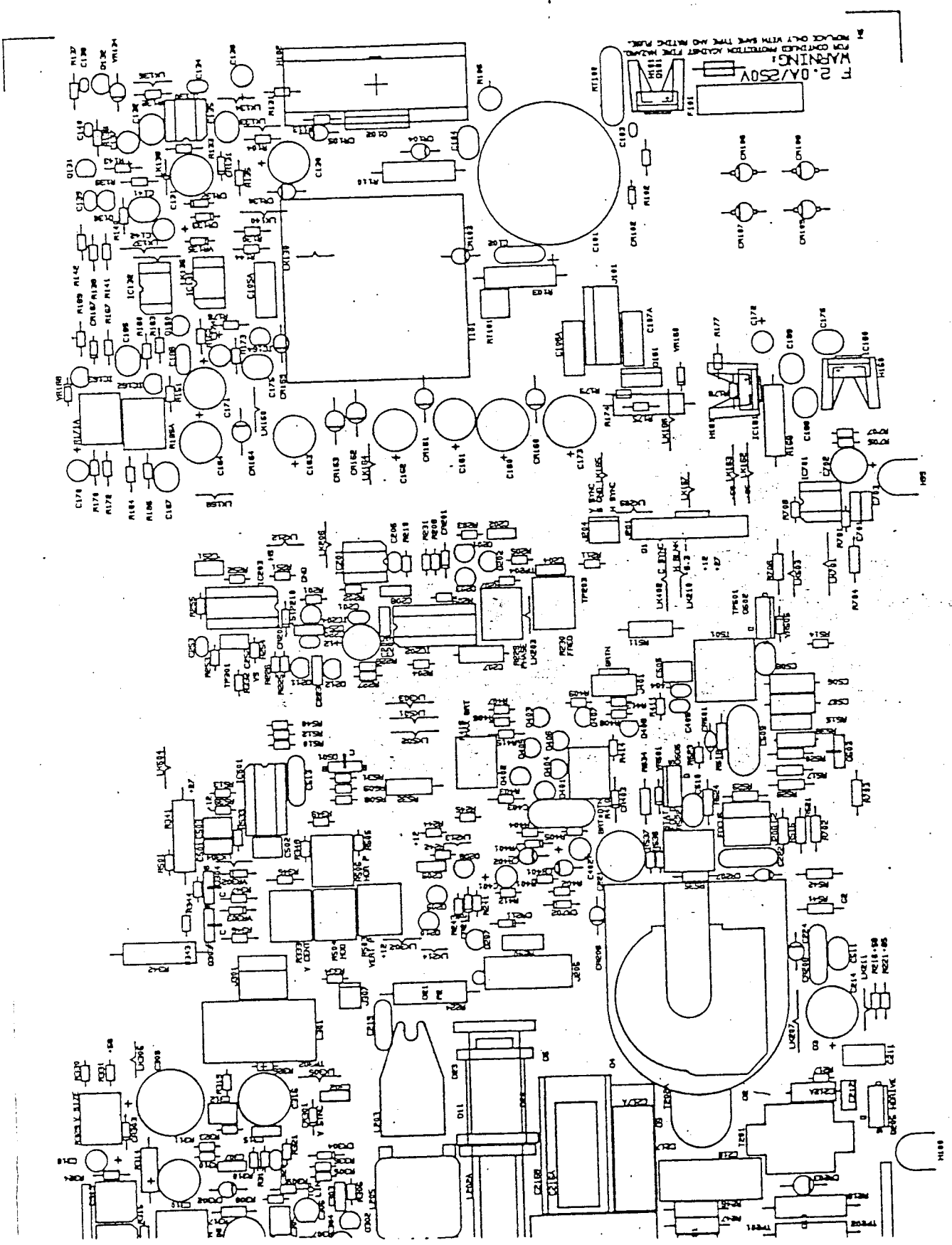

WARNING!
DO NOT TOUCH THE KEYS FROM THE PANEL
T2-DV/R250V

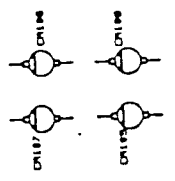

LABORATORY
OFFICE
RECEPTION
STORAGE
CORRIDOR
ELEVATOR

LABORATORY
OFFICE
RECEPTION
STORAGE
CORRIDOR
ELEVATOR

LABORATORY
OFFICE
RECEPTION
STORAGE
CORRIDOR
ELEVATOR

LABORATORY
OFFICE
RECEPTION
STORAGE
CORRIDOR
ELEVATOR

LABORATORY
OFFICE
RECEPTION
STORAGE
CORRIDOR
ELEVATOR

LABORATORY
OFFICE
RECEPTION
STORAGE
CORRIDOR
ELEVATOR

LABORATORY
OFFICE
RECEPTION
STORAGE
CORRIDOR
ELEVATOR

LABORATORY
OFFICE
RECEPTION
STORAGE
CORRIDOR
ELEVATOR

LABORATORY
OFFICE
RECEPTION
STORAGE
CORRIDOR
ELEVATOR

LABORATORY
OFFICE
RECEPTION
STORAGE
CORRIDOR
ELEVATOR

LABORATORY
OFFICE
RECEPTION
STORAGE
CORRIDOR
ELEVATOR

LABORATORY
OFFICE
RECEPTION
STORAGE
CORRIDOR
ELEVATOR

LABORATORY
OFFICE
RECEPTION
STORAGE
CORRIDOR
ELEVATOR

PART NO.
5107 991 05491
SHEET 48 OF 79

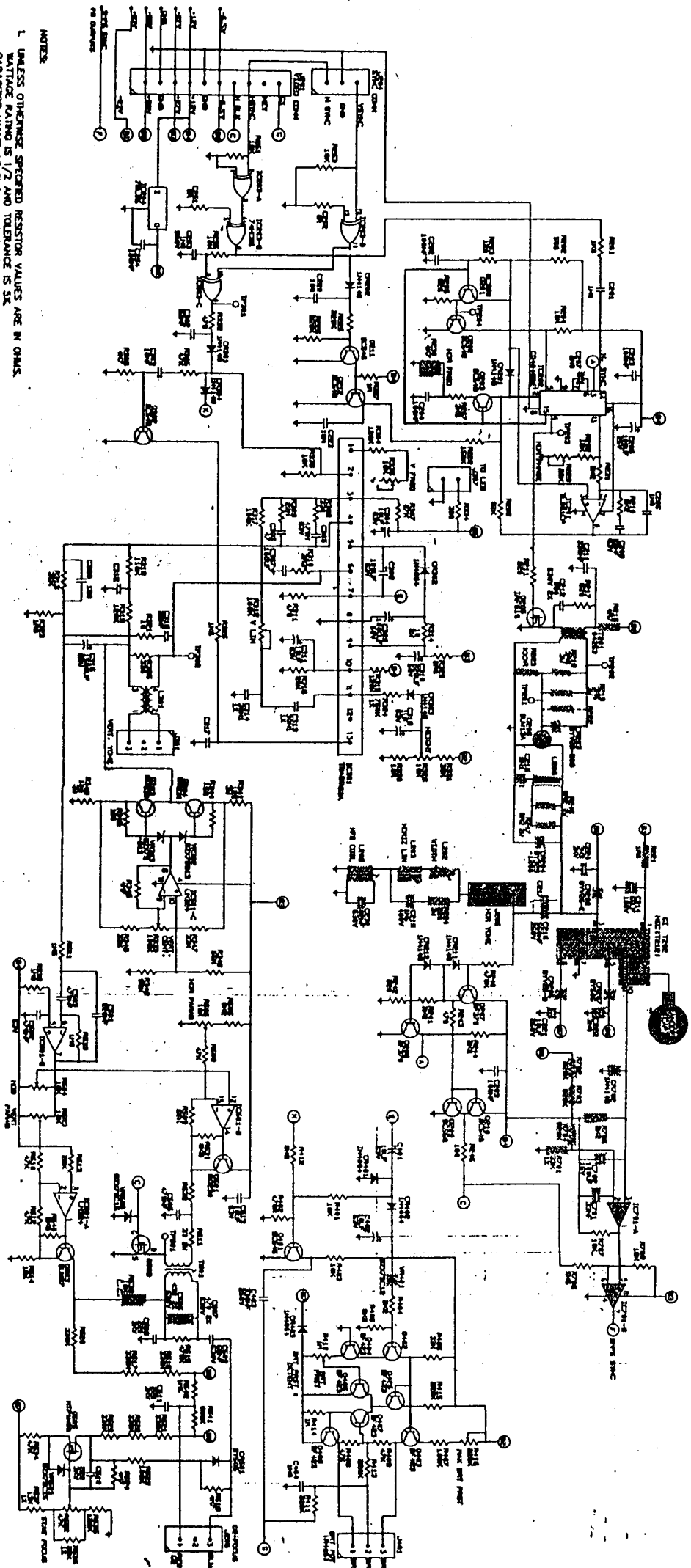

- NOTES
1. UNLESS OTHERWISE SPECIFIED RESISTOR VALUES ARE IN OHMS.
WATTAGE RATING IS 1/2 AND TOLERANCE IS 5%.
CAPACITOR VALUE AS SHOWN AND TOLERANCE IS 10%.
ELECTROLYTIC CAPACITORS TOLERANCE IS 20%.
 2. L - CIRCUIT CONNECTION.
 - 1 + NO CONNECTION.
 - 4 // CHASSIS (EARTH) GROUND.
 - 3 ⊥ GROUND.

FOR THE CONTINUED SAFE OPERATION OF THIS PRODUCT, IT IS IMPERATIVE THAT COMPONENTS SHOWN IN THE SHADED AREAS BE REPLACED ONLY WITH THOSE SPECIFIED IN THE PARTS LIST OF THIS MANUAL. USE OF SUBSTITUTE REPLACEMENT PARTS, WHICH DO NOT HAVE THE SAME SAFETY CHARACTERISTICS AS THOSE SPECIFIED, MAY CREATE SHOCK, FIRE, X-RADIATION AND OTHER HAZARDS.

FOR MAXIMUM RELIABILITY AND PERFORMANCE, ALL OTHER PARTS MUST BE REPLACED BY THOSE HAVING IDENTICAL SPECIFICATIONS. SEALED POTENTIOMETERS IN SHADED AREAS MUST BE RESEALED WITH APPROVED SEALANT AFTER FIELD ADJUSTMENT OR REPLACEMENT. UNDER NO CIRCUMSTANCES MAY THE ORIGINAL DESIGN BE MODIFIED OR ALTERED WITHOUT PERMISSION FROM PHILIPS ELECTRONICS LTD.

507 991	SCHEMATIC DEFLECTION
<p>5107 991 05491</p>	